

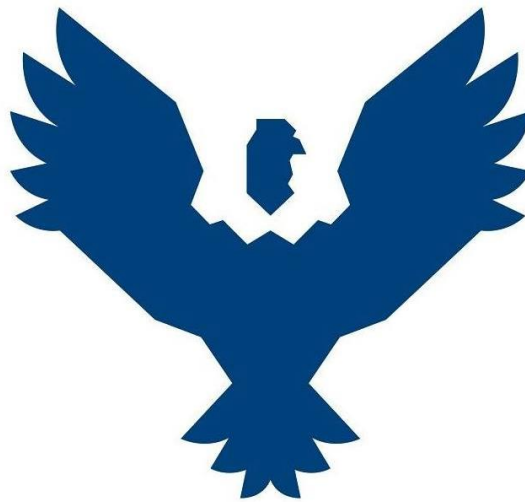

UNIVERSIDAD ANDINA DEL CUSCO

FACULTAD DE INGENIERÍA Y ARQUITECTURA

ESCUELA PROFESIONAL DE INGENIERÍA CIVIL



TESIS

“ANÁLISIS DE LA CIRCULACIÓN VEHICULAR ENTRE LOS ÓVALOS MARTIN CHAMBI, OVALO PACHACUTEC y OVALO LIBERTADORES DESARROLLANDO UNA PROPUESTA DE MEJORA OPERACIONAL Y GEOMÉTRICA.”

Presentado por el Bachiller:

Mario Carrión Concha

Para optar el Título Profesional de:

Ingeniero Civil

Asesor:

Mgt. Ing. Jean Fernando Pérez Montesinos

CUSCO – PERU

2022



“ANÁLISIS DE LA CIRCULACIÓN VEHICULAR ENTRE LOS ÓVALOS MARTÍN CHAMBI, OVALO PACHACUTEC Y OVALO LIBERTADORES DESARROLLANDO UNA PROPUESTA DE MEJORA OPERACIONAL Y GEOMÉTRICA.

dcf`A Uf]c`7Uff]cb`7cbWU

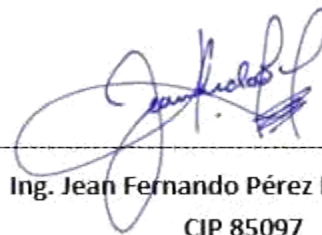

Ing. Jean Fernando Pérez Montesinos

CIP 85097

Fecha de entrega: 13-oct-2021 10:39p.m UTC-0500)

Identificador de la entrega: 1673436915

Nombre del archivo: TESIS_MARIO_FINAL.docx (19.64M)

Total de palabras: 10917

Total de caracteres: 61241



UNIVERSIDAD ANDINA DEL CUSCO

FACULTAD DE INGENIERÍA Y ARQUITECTURA

ESCUELA PROFESIONAL DE INGENIERÍA CIVIL



TESIS

“ANÁLISIS DE LA CIRCULACIÓN VEHICULAR ENTRE LOS ÓVALOS MARTIN
CHAMBI, OVALO PACHACUTEC y OVALO LIBERTADORES DESARROLLANDO
UNA PROPUESTA DE MEJORA OPERACIONAL Y GEOMÉTRICA.”

Presentado por los Bachilleres:

Mario Carrión Concha

Para optar el Título Profesional de:

Ingeniero Civil

Asesor:

Mgt. Ing. Jean Fernando Pérez Montesinos

CUSCO – PERU

2021

Ing. Jean Fernando Pérez Montesinos

CIP 85097



MARTIN CHAMBI, OVALO PACHACUTEC y OVALO LIBERTADORES DESARROLLANDO UNA PROPUESTA DE MEJORA OPERACIONAL Y GEOMÉTRICA.

INFORME DE ORIGINALIDAD

24%

INDICE DE SIMILITUD

20%

FUENTES DE INTERNET

3%

PUBLICACIONES

7%

TRABAJOS DEL ESTUDIANTE

ENCONTRAR COINCIDENCIAS CON TODAS LAS FUENTES (SOLO SE IMPRIMIRÁ LA FUENTE SELECCIONADA)

2%

★ repositorio.ug.edu.ec

Fuente de Internet

Excluir citas

Apagado

Excluir coincidencias < 3 words

Excluir bibliografía

Activo

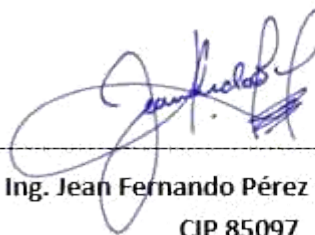

Ing. Jean Fernando Pérez Montesinos
CIP 85097



Dedicatoria

Dedico éste y todos mis esfuerzos a mis padres, por darme la vida y por ser mi fortaleza, a mi hermana por ser mi inspiración, a toda mi familia y amistades por estar siempre apoyándome en todo momento y a mis docentes por el incondicional apoyo a lo largo de estos años.

Mario Carrión Concha.



Agradecimientos

Quiero agradecer a mi familia, por darme fortalezas para seguir adelante y alentarme a concluir la tesis de grado. Así mismo, dar gracias a todos los docentes de la Universidad Andina del Cusco por los conocimientos ofertados durante mi estancia en esta casa de estudios.

Mario Carrión Concha.



Resumen

La presente investigación tuvo por objeto el de analizar la circulación entre los óvalos Chambi, Pachacutec y Ovalo Libertadores. Generando alternativas de solución para mejorar la circulación de este corredor vial, que lleva gran parte del tráfico de la ciudad, desde el Centro histórico hasta la zona del aeropuerto y vecindades aledañas.

La presente analizar el estado situacional del tráfico, mediante una modelación del tráfico existente en la zona de estudio, describiendo los niveles de servicio y congestión. Posteriormente se ensayó una potencial solución para lograr mejorar los niveles de servicio mediante la disminución de demoras.

El análisis de capacidad vial realizado en los óvalos e intersecciones aledañas mediante una micro simulación en el software SYNCHRO nos ha permitido ver opciones de ampliar esta capacidad tanto con soluciones geométricas como soluciones operacionales mediante la metodología de análisis de demoras control en las intersecciones existente y propuestas.



Abstract

The purpose of this research was to analyse the circulation between the Chambi, Pachacutec and Ovalo Libertadores roundabouts. Generating solution alternatives to improve the circulation of this road corridor, which carries much of the city traffic, from the historic center to the airport area and surrounding neighborhoods.

The present analyzes the situational state of traffic, by modeling the traffic existing in the study area, describing the levels of service and congestion. A potential solution was subsequently tested to improve service levels by reducing delays.

The analysis of road capacity carried out in the ovals and intersections surrounding by microsimulation in SYNCHRO software has allowed us to see options to expand this capacity with both geometric solutions and operational solutions through the methodology of analysis of delays control at existing and proposed intersections.



Introducción

El ejercicio profesional y la investigación, son los principios de la Ingeniería Civil donde se busca mejorar la circulación de las personas con un enfoque de movilidad sostenible. Por tanto, la Av. San Martín/Av. 28 de Julio de la ciudad del Cusco, es escenario de constantes accidentes de tránsito, donde las características geométricas, velocidad de diseño, sistemas de control, volumen peatonal y volumen vehicular son factores que influyen en la reducción de la capacidad vial, el cual deben ser analizados para determinar su incidencia y origen de los accidentes con consecuencias negativas para las personas dentro del entorno urbano.

El presente trabajo de investigación tiene como objetivo general Analizar la circulación vial en la Av. San Martín/Av. 28 de Julio de la ciudad del Cusco. Este análisis se realizará de acuerdo al Manual de Capacidad Vial HCM 2016, , que por su metodología nos permitirá determinar las principales demoras vehiculares que se muestran en las variables a estudiar y en la generación de accidentes en el entorno urbano a analizarse.



INDICE GENERAL

Dedicatoria	1
Agradecimientos.....	2
Resumen	3
Abstract	4
Introducción	5
INDICE DE TABLAS.....	10
INDICE DE FIGURAS	11
Capítulo I: Planteamiento del Problema.....	13
1.1. Identificación del Problema:.....	13
1.1.1. Descripción de Problema.....	13
1.1.2. Formulación Interrogativa del Problema:.....	17
1.1.2.1. Formulación Interrogativa del Problema General.....	17
1.1.2.2. Formulación Interrogativa de los Problemas Específicos.....	17
1.2. Justificación e Importancia de la Investigación.....	18
1.2.1. Justificación Técnica	18
1.2.2. Justificación Social.....	18
1.2.3. Justificación por Viabilidad.	19
1.2.4. Justificación por Relevancia.....	19
1.3. Limitaciones de la investigación	19
1.3.1. Limitaciones por especialidad	19
1.3.2. Limitaciones por espacio.....	19
1.3.3. Limitaciones por tiempo.....	19
1.3.4. Limitaciones por datos	19
1.3.5. Limitaciones por fuente de base.....	20
1.4. Objetivos.....	20



Objetivo General	20
1.4.1.	
1.4.2. Objetivos específicos.....	20
2.....	21
Capítulo II: Marco Teórico.....	21
2.1. Antecedentes de la Tesis.....	21
2.1.1. Antecedentes a nivel Nacional:	21
2.1.3. Antecedentes a nivel Internacional:	23
2.2. Base Teórico – Científicas.....	24
2.2.1. Variables relacionadas con el flujo	24
2.2.2. Tasa del flujo (q) y volumen (Q).....	24
2.2.3. Intervalo simple (hi)	24
2.2.4. Intervalo promedio h	24
Variables relacionadas con la velocidad	25
Variables relacionadas con la densidad.....	25
Capacidad.....	26
Niveles de servicio	27
Cálculo de la capacidad.....	29
Intersecciones a nivel y desnivel.....	31
Procedimiento general para el diseño de una intersección vial.....	32
.....	34
2.3. Hipótesis	36
2.3.1. Hipótesis general	36
Sub – Hipótesis.....	36
2.4. Definición de variables	37
2.4.1. Variables independientes.....	37
2.4.2. Variables dependientes.....	37
2.4.3. Cuadro de operacionalización de variables	37
Capítulo III: Metodología.....	39



1.	Metodología de la Investigación.....	39
3.1.	Tipo de Investigación	39
3.1.1.	Nivel o alcance de la investigación:	39
3.1.2.	Método de Investigación:	40
3.2.	Diseño de la Investigación.....	40
3.2.1.	Diseño Metodológico:	40
3.2.2.	Diseño de ingeniería.....	41
3.3.	Población y Muestra	42
3.3.1.	Población.....	42
3.3.1.1.	Descripción de la Población.....	42
3.3.1.2.	Cuantificación de la Población	42
3.3.2.	Muestra.....	42
3.3.2.1.	Descripción de la Muestra.....	42
3.3.2.2.	Cuantificación de la Muestra	42
3.3.2.3.	Método de Muestreo	43
3.3.2.4.	Criterios de Evaluación de Muestra.....	43
3.3.3.	Criterios de Inclusión	43
3.4.	Instrumentos	43
3.4.1.	Instrumentos Metodológicos o Instrumentos de Recolección de Datos.....	43
3.4.2.	Instrumentos de ingeniería	45
1.1.1.1.	Software SYNCHRO educacional:.....	45
3.5.	Procedimientos de Recolección de Datos.....	47
1.1.2.	Codificación de la geometría.....	47
1.1.3.	Volúmenes vehiculares	58
1.1.4.	Tiempos semafóricos.....	69
Capítulo IV:	RESULTADOS	74
4.1.	Resultado de la situación actual.....	74
Glosario	76



Conclusiones	81
5 Recomendaciones.....	83
5.1. RECOMENDACIÓN N°1	83
5.2. RECOMENDACIÓN N°2	83
5.3. RECOMENDACIÓN N°3	83
5.4. RECOMENDACIÓN N°4	83
5.5. RECOMENDACIÓN N°5	83
6 Referencias	84



INDICE DE TABLAS

Tabla 1 : Factores de corrección para el cálculo de la intensidad de saturación	31
Tabla 2: instrumentos de ingeniería	45
Tabla 3. Configuración de la geometría, anchos de carril y velocidad en las vías.....	57
Tabla 4. Configuración de la demanda vehicular, factor de hora punta, factor de crecimiento, porcentaje de vehículos pesados, parqueos y estacionamientos.....	58
Tabla 5. Tipo de semaforización, ciclo semafórico.....	69
Tabla 6. Configuración de fases, tiempo de verde, split total, ámbar y rojo total.....	69



INDICE DE FIGURAS

Figura 1: Mapa a nivel Departamental (Cusco)	Figura 2: Mapa a nivel Provincial (Cusco)	
.....	13
Figura 3: Mapa a nivel distrital (Cusco).....		14
Figura 4 : Esquema base intersección a desnivel tipo “Trompeta” en carreteras no divididas.		33
Figura 5: Esquema base intersección a desnivel tipo “Trompeta” en carreteras divididas.		35
Figura 6: Proceso cuantitativo.....		39
Figura 7. Nodo 1.....		47
Figura 8. Nodo 2.....		48
Figura 9. Nodo 3.....		49
Figura 10. Nodo 4.....		50
Figura 11. Nodo 5.....		51
Figura 12. Nodo 6.....		52
Figura 13. Nodo 7.....		53
Figura 14. Nodo 8.....		54
Figura 15. Nodo 9.....		55
Figura 16. Nodo 10.....		56
Figura 17. Nodo 11.....		57
Figura 18. Nodo 1.....		58
Figura 19. Nodo 2.....		59
Figura 20. Nodo 3.....		60
Figura 21. Nodo 4.....		61
Figura 22. Nodo 5.....		62
Figura 23. Nodo 6.....		63
Figura 24. Nodo 7.....		64
Figura 25. Nodo 8.....		65
Figura 26. Nodo 9.....		66
Figura 27. Nodo 10.....		67
Figura 28. Nodo 11.....		68
Figura 29. Nodo 1 – Tiempos semafóricos y fases.		70
Figura 30. Nodo 2 – Tiempos semafóricos y fases.		70
Figura 31. Nodo 3 – Tiempos semafóricos y fases.		71
Figura 32. Nodo 7 – Tiempos semafóricos y fases.		71



Figura 33. Nodo 9 – Tiempos semafóricos y fases.	72
Figura 34. Nodo 10 – Tiempos semafóricos y fases.	72
Figura 35. Nodo 11 – Tiempos semafóricos y fases.	73
Figura 36. Eliminar nodos de conflicto.	75



Capítulo I: Planteamiento del Problema

1.1. Identificación del Problema:

1.1.1. Descripción de Problema:

La investigación que se desarrollará en la tesis tendrá su campo de actividades en la Avenida 28 de Julio y Av. San Martín de la ciudad del Cusco ver Figuras 1,2,3 y 4.

- País: Perú
- Región: Cusco
- Provincia: Cusco
- Distritos: Wanchac



Figura 1: Mapa a nivel Departamental (Cusco)

Fuente: MTC



Figura 2: Mapa a nivel Provincial (Cusco)

Fuente: MTC



Figura 3: Mapa a nivel distrital (Cusco)

Fuente: MTC



En general, el eje Vía Expresa - San Martín - Av. del Ejército dispone de una capacidad importante en sección (tres o cuatro carriles por sentido de circulación). No obstante, la capacidad del eje está reducida en los cruces (óvalos Chambi, Pachacutec y Libertadores). Esta gestión de flujos dista de ser óptima y genera congestión.

Según los conteos vehiculares de la Municipalidad Provincial del Cusco en los reportes del estudio operacional de accesibilidad al Centro Histórico, los flujos en los ejes principales llegan aproximadamente a los 3'500 vehículos por hora en la hora punta de la mañana. El análisis de estos flujos por sentido, origen y destino muestra que el óvalo Pachacutec tiene una función de cruce de diversión del tráfico, y permite entonces distribuir los flujos.

El óvalo Martín Chambi asegura la convergencia entre la avenida El Sol y la avenida del Ejército, así como flujos importantes que viene de Av. Agustín Gamarra. Los otros flujos son menores.

Hoy en día, el óvalo Martín Chambi está regulado por semáforos divididos en dos nodos, según dato de la Gerencia de Tránsito se tiene:

— Un primer nodo que junta las avenidas El Sol, del Ejército y San Martín, con un ciclo de



120 segundos; El segundo entre las calles Confraternidad y San Martín, con un ciclo de 80 segundos. La diferencia entre la duración de ciclos en nodos tan cercanos como estos induce una irregularidad de flujos y conflictos. Por lo tanto, se propone una regulación del óvalo como un solo nodo y con una duración de ciclo de 90 segundos. Además, con una mejor disposición de la red viaria, la capacidad del óvalo se puede aumentar de 100%.

El óvalo Pachacutec presenta una gran heterogeneidad de flujos. Para satisfacer la demanda y priorizar el flujo sobre el eje principal se proponen las siguientes medidas:

- Aumentar el número de carriles de giro hacia la izquierda, desde la Av. 28 de Julio
- Establecer una gestión con semáforo de las entradas a las calles Antonio Sucre y L. Vallejos Santoni.

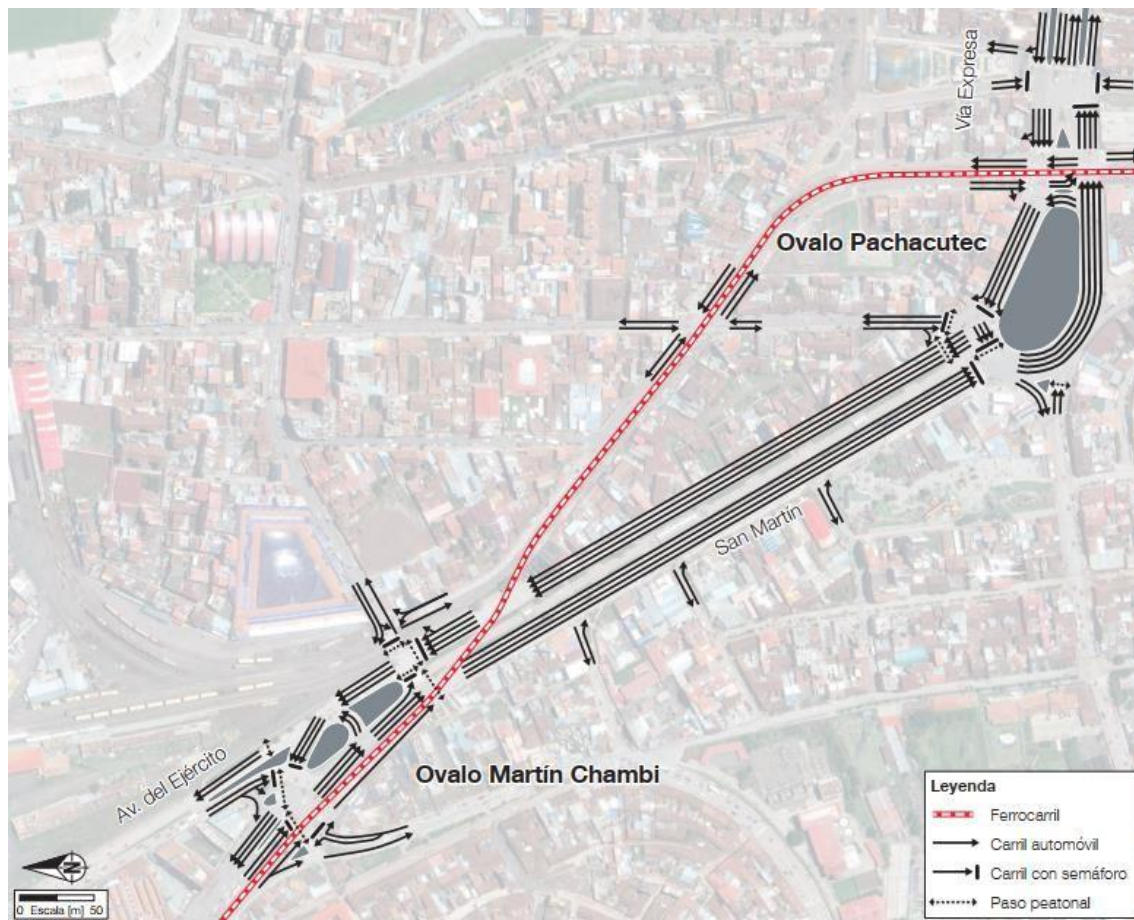



PUNTOS DE CONFLICTO



1.1.2. **Formulación Interrogativa del Problema:**

1.1.2.1. **Formulación Interrogativa del Problema General.**

¿Cuál es el nivel de servicio del sistema vial entre los Óvalos de Martín Chambi, Pachacutec y Libertadores?

1.1.2.2. **Formulación Interrogativa de los Problemas Específicos.**

a) Problema específico N° 01.

¿Cómo varían las condiciones de tráfico que influyen en la capacidad vial de las intersecciones de los óvalos aplicando la metodología del HCM 2010 y simulación?

b) Problema específico N° 02.

¿Cuál es la diferencia de las condiciones geométricas que influyen en la capacidad vial semaforizadas y no semaforizadas de los óvalos Martín Chambi, Pachacútec y Libertadores aplicando la metodología del HCM 2010 y simulación?



- c) Problema específico N° 03.
 - d) ¿Cuál es el estado de las condiciones semafóricas que influyen en la capacidad vial semaforizadas y no semaforizadas de los óvalos Martin Chambi, Pachacútec y Libertadores aplicando la metodología del HCM 2010 y simulación?
- e) Problema específico N° 04.
 - ¿Cuál es la diferencia de los tiempos de demora que influyen en el nivel de servicio semaforizadas y no semaforizadas de los óvalos Martin Chambi, Pachacútec y Libertadores aplicando la metodología del HCM 2010 y simulación?
- f) Problema específico N° 05.
 - ¿Qué relación de saturación tienen las intersecciones semaforizadas y no semaforizadas de los óvalos Martin Chambi, Pachacútec y Libertadores aplicando la metodología del HCM 2010 y simulación?
- g) Problema específico N° 06.
 - ¿Cuál es la propuesta de solución para mejorar la circulación vehicular entre los óvalos Martin Chambi, Pachacútec y Libertadores aplicando la metodología del HCM 2010 y simulación?

1.2. Justificación e Importancia de la Investigación.

1.2.1. Justificación Técnica.

El siguiente trabajo de investigación nos permitirá determinar los factores que inciden en la generación de accidentes en la Av. San Martín/Av. 28 de Julio de la ciudad del Cusco, analizando la seguridad vial, Características geométricas, velocidad de circulación, sistemas de control, la volúmenes vehicular y peatonal, dando como resultado propuestas que nos ayuden a reducir el índice de accidentes lo que se obtendrá mediante las fichas de inspección de seguridad vial.

1.2.2. Justificación Social.

Los principales beneficiarios de esta investigación serán los estudiantes de distintas carreras profesionales que realicen estudios e investigación acerca de la Av. San Martín/Av. 28 de Julio de la ciudad del Cusco, así como los pobladores de las distintas asociaciones colindantes con esta vía para la reducción de accidentes de tránsito, de igual manera a los gobiernos regionales, locales con aportes de alternativas de solución técnica y aplicables.



1.2.3. **Justificación por Viabilidad.**

La presente investigación es viable por los siguientes motivos:

- Los datos que requiere el método planteado por el (MSV 2017), para obtener resultados serán recopilados y accesibles.
- Es viable económicamente por que los gastos que implique la investigación pueden ser asumidos.
- Se cuenta con el manual (MSV 2017), para poder seguir correctamente las fichas de inspección y auditoria.
- Los equipos a utilizarse para el levantamiento topográfico son accesibles económicamente.

1.2.4. **Justificación por Relevancia**

La investigación será relevante porque nos permitirá determinar los factores que ocasionan accidentes viales en la Av. San Martín/Av. 28 de Julio de la Ciudad del Cusco, donde podremos formular propuestas de mejoramiento de acuerdo a las fichas técnicas del (MSV), y así solucionar los problemas planteados, que puedan ser replicados en otro tipo de infraestructuras semejantes.

1.3. **Limitaciones de la investigación**

1.3.1. **Limitaciones por especialidad**

La presente investigación se limita en la rama de Ingeniería de Transportes y no discute las diferentes ramas de la Ingeniería Civil.

1.3.2. **Limitaciones por espacio**

En la actualidad las dificultades en el tránsito van en aumento día a día, la congestión vehicular, bajas velocidades, embotellamientos, debido al aumento anual de la demanda vehicular, la cual se ve reflejada en la Av. San Martín/Av. 28 de Julio de la Ciudad del Cusco, motivo por el cual se analizará mediante una inspección de seguridad vial.

1.3.3. **Limitaciones por tiempo**

- La presente investigación utiliza datos actuales entre los meses de agosto a octubre del año 2021, en todos los días de la semana de 7:00 am a 7:00 pm.
- La recolección de datos para la ISV se limita a la hora de la máxima demanda vehicular.

1.3.4. **Limitaciones por datos**

En la presente investigación los datos para la Inspección de Seguridad Vial se dieron exclusivamente en campo con inventarios viales, fotos, levantamiento topográfico de las zonas



estudiadas para luego ser analizadas con apoyo de las listas de chequeo del Manual de Seguridad Vial – 2017.

En nuestra investigación no se pudo realizar el ensayo de REFLECTOMETRIA por tener un alto costo de los aparatos RETROREFLECTOMETROS los cuales son considerados como parte del procedimiento de nuestra investigación para realizar una inspección de seguridad vial del Manual de Seguridad Vial.

1.3.5. Limitaciones por fuente de base

Para el estudio de la Inspección de Seguridad Vial se aplica la metodología de Inspección ISV del Manual de Seguridad Vial - 2017, en el cual se detalla el procedimiento en un flujo grama de 5 fases para realizar esta inspección.

La Inspección para la mejora de las características físicas de las intersecciones estudiadas se dará mediante Listas de Chequeo del Manual de Seguridad Vial - 2017.

Se sabe que el Manual de Seguridad Vial, es exclusivamente para zonas rurales las cuales en nuestra investigación se aplicó en zonas urbanas, tratando de observar deficiencias parecidas o negativas para poder darle una solución y recomendaciones del caso.

1.4. Objetivos

1.4.1. Objetivo General

Analizar los niveles de servicio de las intersecciones del sistema vial entre los óvalos aplicando la metodología del HCM 2010 y simulación.

1.4.2. Objetivos específicos

Objetivo específico N° 01.

Determinar las condiciones de tráfico que influyen en la capacidad vial de las intersecciones semaforizadas y no semaforizadas de los óvalos aplicando la metodología del HCM 2010 y simulación

Objetivo específico N° 02.

Determinar la diferencia de las Condiciones geométricas que influyen en la capacidad vial semaforizadas y no semaforizadas de los óvalos aplicando la metodología del HCM 2010 y simulación



Objetivo específico N° 03.

Determinar estado de las condiciones semaforicas que influyen en la capacidad vial semaforizadas y no semaforizadas de los óvalos aplicando la metodología del HCM 2010 y simulación

Objetivo específico N° 04.

Determinar los tiempos de demora que influyen en el nivel de servicio semaforizadas y no semaforizadas de los óvalos aplicando la metodología del HCM 2010 y simulación

Objetivo específico N° 05.

Determinar la relación de saturación tienen las intersecciones semaforizadas y no semaforizadas de los óvalos aplicando la metodología del HCM 2010 y simulación

Objetivo específico N° 06.

Desarrollar una propuesta de solución para la circulación entre los óvalos aplicando la metodología del HCM 2010 y simulación del tráfico.

Capítulo II: Marco Teórico

2.1. Antecedentes de la Tesis.

2.1.1. Antecedentes a nivel Nacional:

2.1.1.1. Análisis para la determinación del nivel de servicio y demora en intersecciones viales semaforizadas

- Autor: Ing. Gonzalo A. Ramírez Vélez
- Año: Lima, 2004
- UNIVERSIDAD: Universidad Nacional de Ingeniería

RESUMEN: El presente trabajo desea proporcionar una herramienta para el análisis y determinación del nivel de servicio y demora en una intersección semaforizada, aplicable a las condiciones de tráfico urbano que impera en nuestro país.

El procedimiento que se presenta en este trabajo hace referencia a la capacidad, nivel de servicio de las aproximaciones que conforman las intersecciones, y el nivel de servicio de la intersección como un todo. La capacidad es evaluada en términos de la



relación de la tasa de flujo de demanda (volumen) y la capacidad, es decir la relación v/c , mientras que el nivel de servicio es evaluado basándose en el promedio de demora por vehículo (segundos por vehículo).

- **APORTE A LA INVESTIGACION:**

El análisis de una intersección bajo esta metodología producirá los indicadores: • Relaciones volumen – capacidad para cada aproximación a la intersección

- Control promedio de demora para cada aproximación y para toda la intersección, así como los correspondientes Niveles de Servicio.

- Permite evaluar el desempeño de las programaciones semafóricas.

Dado que esta metodología provee un análisis total de la capacidad y nivel de servicio, puede ser usada para evaluar alternativas de demanda de tráfico, diseño geométrico, planes de semaforización, que ayuden a corregir el comportamiento de la intersección.

2.1.2. **Análisis del Flujo Vehicular - de los Óvalos Libertadores, Garcilaso y Tacna - Intersecciones Giratorias en comparación con el comportamiento de intersección semaforizadas sometidas a la misma demanda**

- **AUTOR:** Jimmy Carol Chalco Castillo
- **AÑO:** Cusco, 2015
- **UNIVERSIDAD:** Universidad Andina del Cusco
- **RESUMEN:** La presente tesis estudia el análisis de la capacidad vial de las intersecciones giratorias (glorietas, rotondas) en comparación con el modelamiento de intersecciones viales semaforizadas (ramales múltiples) sometidas a la misma demanda de la ciudad del Cusco, determinando la capacidad vial y/o nivel de servicio de la intersecciones viales giratorias y simulando un sistema vial semaforizada que compara dicho nivel de servicio de las intersecciones de estudio.

Esta tesis se elaboró con la finalidad de entender las características y el comportamiento del tránsito de las glorietas o rotondas en comparación de las intersecciones viales Semaforizadas, la cual permite optimizar la funcionalidad de las intersecciones de estudio bajo los principios de eficiencia, seguridad y modernidad que todo tipo de infraestructura vial tiene que contar para su optima funcionalidad



- **APORTE A LA INVESTIGACIÓN.**

La glorieta o rotonda (en especial la multi-carril) es una de las infraestructuras más seguras y eficientes, que permite canalizar el flujo vehicular de manera más ordenada, permitiendo minimizar las demoras que se producen en una intersección a comparación con una intersección común.

2.1.3. **Antecedentes a nivel Internacional:**

Análisis de la Capacidad y nivel de servicio de la vía Loja – Vilcabamba (tramo de estudio Loja – Landangui) aplicando la metodología del HCM- 2010

- **AUTOR :** Martínez Aldean Diego Fernando
- **AÑO :** Ecuador, 2014
- **UNIVERSIDAD:** Universidad Técnica Particular de Loja
- **RESUMEN:** En el presente estudio se detalla el proceso de investigación del análisis de la vía Loja Vilcabamba, en el tramo Loja –Landangui, con el fin de determinar su capacidad y nivel de servicio , aplicando la metodología propuesta por el Highway Capacity Manual 2000, se escogió la vía que conecta la ciudad de Loja con las ciudades de Vilcabamba y Malacatos, esta vía presenta una gran cantidad de flujo vehicular debido a que son unos de los principales puntos de atracción turística en la provincia de Loja.

Este trabajo investigado detalla cada una de las etapas ejecutadas, desde el levantamiento de información de campo (aforo de vehículos y medición de las características geométricas), tabulación de datos y análisis de resultados.

- **APORTE A LA INVESTIGACIÓN.**

Todas las variables que intervienen en la determinación de la capacidad y el nivel de servicio, se encuentran clara y objetivamente definidas bien sea por mediciones de campo o por datos consignados en el manual de Capacidad y Niveles de Servicio para carreteras de dos carriles (HCM2000).



2.2. Base Teórico – Científicas

2.2.1. Variables relacionadas con el flujo

Las variables relacionadas son la tasa de flujo, el volumen el intervalo simple entre vehículos consecutivos y el intervalo promedio entre varios vehículos.

2.2.2. Tasa del flujo (q) y volumen (Q)

La tasa de flujo “q” es la frecuencia a la cual pasan los vehículos por un punto 0 sección transversal de un carril o calzada .La tasa de flujo es pues el número de vehículos N que pasan durante un intervalo de tiempo “T” a una hora, expresada en veh / min. No obstante la tasa de flujo q también puede ser expresada en veh / hora, teniendo cuidado con su interpretación, pues no se trata del número de vehículos que efectivamente pasan durante una hora completa o volumen horario “q”.

La tasa de flujo se calcula entonces con la siguiente expresión:

$$q = \frac{N}{T}$$

Donde : q: es la tasa de flujo en veh/minuto

N: número de vehículos

T: tiempo en minutos

(Cardenas, 2007)

2.2.3. Intervalo simple (hi)

Es el intervalo de tiempo entre el paso de los vehículos consecutivos, generalmente expresado en segundos y medido entre puntos homólogos del par de vehículos.

2.2.4. Intervalo promedio \bar{h}

Es el promedio de todos los intervalos simples hi existente entre diversos vehículos que simulan por una vialidad .Por tratarse de un promedio se expresa en segundos por vehículo y se calcula mediante la siguiente expresión:

$$\bar{h} = \sum_{i=1}^{N-1} hi / N - 1$$

Donde:

h : intervalo promedio (s/veh)

N : Numero de vehículos (veh)



$N-1$: Numero de intervalos (veh)

h_i : intervalo simple entre el vehículo i y el vehículo $i + 1$

Las unidades de intervalo promedio \bar{h} (s/veh) son las unidades inversas de la tasa de flujo “ q ” (veh/s), por lo que se plantea la siguiente ecuación.

$$\bar{h} = \frac{1}{q}$$

Donde: q : es la tasa de flujo (veh/min)

h : intervalo entre vehículos (segundos/vehículos)

(Cardenas, 2007)

Variables relacionadas con la velocidad

Las variables del flujo vehicular relacionadas con la velocidad son la velocidad de punto, la velocidad instantánea, la velocidad de marcha temporal, la velocidad media espacial, la velocidad de recorrido.

Variables relacionadas con la densidad

Las variable de flujo vehicular relacionadas con la densidad son la densidad o concentración, el espaciamento simple entre vehículos consecutivos y el espaciamento promedio entre varios vehículos.

Densidad o concentración (K)

Es el número N de vehículos que ocupan una longitud específica “ a ”, de una vialidad en un momento dado. Generalmente se expresa en vehículos por kilómetro (veh / km), ya sea referido a un carril o a todos los carriles de una calzada, se calcula como:

$$K = \frac{\text{Numero de vehiculos}}{a}$$

Donde: a es la longitud especifica

Espaciamento simple(si)



La distancia entre el paso de dos vehículos consecutivos, usualmente expresada en metros y medida entre sus defensas traseras.

Espaciamiento promedio (\bar{s})

Es el espaciamento de todos los espaciamentos simples si existentes entre los diversos vehículos que circulan por una vialidad. por tratarse de un promedio se expresa en metros por vehículo (m/ veh) y se calcula, mediante la siguiente expresión:

$$\bar{s} = \sum_{i=1}^{N-1} s_i / N - 1$$

Donde:

S : espaciamento promedio (m/veh)

N : número de vehículos (veh)

N-1 : número de espaciamentos (veh)

Si : Espaciamento simple entre el vehículo i y el vehículo i+1

Las unidades del espaciamento promedio \bar{s} (m/veh) son las unidades inversas de la densidad K (veh/m) por lo que también se puede plantearse la siguiente relación:

$$\bar{s} = \frac{1}{K}$$

Donde: s: es el espaciamento promedio (metros/veh)

k: es la densidad o concentración (veh/km)

(Cardenas, 2007)

Capacidad

Se define como capacidad de una infraestructura de transporte al “flujo máximo horario al que se puede razonablemente esperar que las personas o vehículos atraviesen un punto o sección uniforme de un carril o calzada durante un periodo de tiempo dado, bajo condiciones prevalecientes de la vía, del control y del tránsito”. De la definición anterior se infieren las siguientes consideraciones:

La capacidad puede expresarse en términos de vehículos o en términos de personas, dependiendo del tipo de infraestructura que se está analizando. La capacidad se refiere a un



punto o sección uniforme de la infraestructura; por tanto, segmentos o puntos con diferentes características tendrán diferentes capacidades.

La capacidad se refiere a una tasa de flujo vehicular o personas durante un período de tiempo que muy a menudo es el periodo de 15 minutos pico. La capacidad no se refiere al máximo volumen al que puede darse servicio durante una hora. Esta definición contempla la posibilidad de variaciones significativas del flujo dentro de una hora.

La capacidad se define sobre la base de una “esperanza razonable”. No es la máxima tasa de flujo absoluta jamás observada en el tipo de infraestructura analizada. Debe tenerse en cuenta que se consideran condiciones promedio, y que las características de los conductores, los vehículos y ambientales, puede diferir de una región a otra.

La capacidad está dada bajo condiciones prevalecientes de la vía (características geométricas, tipo de sección, pendientes, dimensiones de carriles, bermas, etc.), del control (dispositivos de control de tránsito como semáforos, señales, movimientos permitidos), y del tránsito (composición vehicular, velocidad, características del flujo vehicular).

(Cardenas, 2007)

Niveles de servicio

El HCM 2000 ha creado una medida cualitativa para definir los diferentes tipos o capacidades de servicio que tiene una vía a los cuales se denomina niveles de servicio (LOS).

El HCM Level of Service LOS denomina a los niveles de servicio como “una medida de calidad que describe las condiciones de funcionamiento dentro de un flujo de tráfico, por lo general en términos de medidas de servicio tales como la velocidad y el tiempo de viaje, la libertad de maniobra, las interrupciones de tráfico, la comodidad y conveniencia.

Según el HCM especifica que hay 6 diferentes niveles de servicio a los cuales los designa con las letras A hasta la F, siendo el nivel “A” el que presta mejores condiciones de funcionamiento y la “F” el de peor.

(Highway Capacity Manual, 2010)

En el libro de ingeniería de carreteras volumen I de Carlos Kraemer se describe cada uno de los de los niveles de servicio los cuales se presenta a continuación



1.1.1.1. Nivel de servicio A

La velocidad de los vehículos es prácticamente igual a la que libremente elegirían sus conductores si no se vieran obligados a modificarla a causa de otros vehículos. Cuando un vehículo alcanza a otro más lento puede adelantarlo con facilidad sin sufrir ninguna demora. Este nivel corresponde a unas condiciones de circulación libre.

Nivel de servicio B

La velocidad de los vehículos, especialmente la de los más rápidos, se ve influenciada por otros vehículos, y puede verse demorados durante ciertos intervalos por otros más lentos, pero no llegan a formarse colas. Este nivel corresponde a unas condiciones de circulación estable.

Nivel de servicio C

La mayor parte de los conductores deberán ajustar su velocidad teniendo en cuenta la de los vehículos que les preceden, porque las posibilidades de adelantamiento son reducidas y se forman grupos de vehículos que circulan a la misma velocidad. La circulación sigue siendo estable, porque las perturbaciones debidas a los cambios de velocidad se suelen disipar sin llegar a producir una detención total.

Nivel de servicio D

Todos los vehículos deben regular su velocidad teniendo en cuenta la marca de los vehículos precedentes. La velocidad media se reduce y se forman largas caravanas, ya que resulta difícil adelantar a otros vehículos. La circulación se aproxima a la inestabilidad, y cualquier incremento en la intensidad del tráfico puede dar lugar a la detención de la circulación.

Nivel de servicio E

La velocidad media de todos los vehículos es prácticamente igual, y se forman largas caravanas con separaciones muy pequeñas entre vehículos, ya que es imposible rebasar. Son frecuentes las detenciones bruscas debidas a cualquier tipo de accidente. La intensidad alcanza la capacidad de la carretera.

Nivel de servicio F



Corresponde a congestión, se ira formando una cola de vehículos que avanzaran muy lentamente. La velocidad media es muy baja e incluso en ocasiones nula. La situación resulta completamente impecable.

(Kraemer) .

Cálculo de la capacidad

En este capítulo se dedica un primer apartado a describir muy brevemente el cálculo de la capacidad que propone el Highway Capacity Manual para las intersecciones semaforizadas, para pasar posteriormente a describir los procesos utilizados en esta tesina para llegar a determinar la capacidad de un tramo a partir de la relación fundamental del tráfico y las intensidades reales registradas.

(Highway Capacity Manual, 2010)

Capacidad de intersecciones semaforizadas SEGÚN HCM 2010

El método de cálculo de la capacidad más conocido y utilizado es el expuesto en el Highway Capacity Manual preparado en estados unidos por el Transportation Research Board (TRB). Este método está basado en estudios realizados en este país desde 1935 y ha sido objeto de cinco ediciones, la última en el año 2000. Aunque algunos países han desarrollado métodos de cálculo de la capacidad con técnicas diferentes, en otros muchos, se ha empleado el manual americano con las modificaciones que la experiencia ha ido aconsejando para su adaptación a las circunstancias locales.

El Highway Capacity Manual, en su versión del año 2010, define los siguientes

Conceptos:

V: Duración de la fase verde (se permite el paso de vehículos) [seg]

R: Duración de la fase roja (no se permite el paso de vehículos) [seg]

T: Ciclo del semáforo = $V + R$ [seg]

Mientras el semáforo esté en su fase de verde podrá pasar por el acceso un número máximo de vehículos hora, que constituye lo que se denomina intensidad de saturación.

Multiplicando esta intensidad de saturación por la relación entre la duración de la fase de verde y la del ciclo se obtiene el máximo número de vehículos que pueden pasar en una hora (capacidad).



$$C = S * \frac{V}{T}$$

Siendo:

C: Capacidad (vehículos/hora)

S: Intensidad de saturación (vehículos/hora)

V: Duración de la fase de verde (segundos)

T: Duración del ciclo (segundos)

Si en un tramo existen carriles reservados para determinados movimientos, como giros a la izquierda o a la derecha, se estudian separadamente de los demás carriles del acceso. Se forman así dentro de un mismo tramo varios grupos de carriles que se analizan separadamente. El procedimiento para el cálculo de la intensidad de saturación para cada grupo es el siguiente:

$$S = 1900 N f_a f_{vp} f_i f_e f_b f_z f_{gd} f_{gi}$$

Siendo:

S: Intensidad de saturación (vehículos/hora)

N: Número de carriles

Fa: factor de ancho de carril

fvp: factor de vehículos pesados

fi: factor de giros a la izquierda

fe: factor de estacionamientos

fb: factor de paraderos de bus

fz: factor de zona urbana

fgd: factor de giros a la derecha

fgi : factor de giros a la izquierda



Tabla 1 : Factores de corrección para el cálculo de la intensidad de saturación

Factores de corrección			
f	Corrección por	Fórmula	Variable
f_a	Anchura del carril	$(5,4+A)/9$	A : anchura del carril (m)
f_{vp}	Vehículos pesados	$100/(100+P)$	P : Porcentaje de pesados (%)
f_i	Inclinación de la rasante	$1-I/100$	I : Inclinación de la rasante
f_e	Estacionamiento	$1-(0,1+M/20)/N$	M : Movimientos de estacionamiento en una hora
f_b	Paradas autobús	$1-B/(250N)$	B : Autobuses que paran por hora
f_z	Situación	$(0,9-1)$	En centro urbano 0,9, en otras zonas 1
f_{gd}	Giros a la derecha	$1 - 0.15P$	P : Proporción de vehículos que giran a la derecha
f_{gl}	Giros a la izquierda	$1/(1+0.05P)$	P : Proporción de vehículos que giran a la izquierda

Referencia: fuente HCM 2010

A pesar que no se disponen de los datos necesarios para la validación del modelo, sí que es cierto que se encuentran a faltar parámetros como la presencia o no de carril bus o la consideración de las paradas en doble fila.

(Highway Capacity Manual, 2010)

Intersecciones a nivel y desnivel

La solución de una intersección vial depende de una serie de factores asociados fundamentalmente a la topografía del sitio, a las características geométricas de las carreteras que se cruzan y a las condiciones de su flujo vehicular. Como generalmente existen varias soluciones, los ingenieros deben proponer alternativas para ser evaluadas y con sus resultados seleccionar la más conveniente. En el presente manual no se restringen los tipos de solución para una intersección dada. Los ingenieros, con su creatividad y buen juicio, podrán proponer las alternativas que consideren adecuadas para las condiciones particulares del proyecto. Solo con el propósito de presentar en forma ordenada los criterios geométricos básicos requeridos para el diseño de los diferentes elementos que integran una intersección, como son las isletas, carriles de aceleración, desaceleración y giro a la izquierda, entrecruzamiento, ramales, etc., se ofrecen algunos diseños típicos frecuentes en carreteras.

(MTC, 2018)



Procedimiento general para el diseño de una intersección vial

El enfoque general recomendado para realizar el diseño geométrico de una intersección presenta una serie de actividades secuenciales, tal como se describe:

- Estudio de tránsito de la intersección y análisis de la situación existente, utilizando, si se requieren, programas de computador apropiado.
- Formulación y evaluación de alternativas de funcionamiento.
- Selección de la alternativa más conveniente.
- Diseño definitivo de la solución adoptada.

(MTC, 2018)

Criterios generales

Con la finalidad de obtener el diseño más conveniente, se presentan los siguientes criterios generales, destacando que se debe optar por la solución más sencilla y comprensible para los usuarios.

Priorización de los movimientos. Los movimientos más importantes deben tener preferencia sobre los secundarios. Esto obliga a limitar los movimientos secundarios con señales adecuadas, reducción de ancho de vía e introducción de curvas de radio pequeño. Eventualmente, convendría eliminarlos totalmente. - consistencia con los volúmenes de tránsito. La mejor solución para una intersección vial es la más consistente entre el tamaño de la alternativa propuesta y la magnitud de los volúmenes de tránsito que circularán por cada uno de los elementos del complejo vial.

- Sencillez y claridad. Las intersecciones que se prestan a que los conductores duden son inconvenientes; la canalización no debe ser excesivamente complicada ni obligar a los vehículos a movimientos molestos o recorridos demasiado largos.

- Separación de los movimientos. A partir de los resultados de ingeniería de tránsito, según los flujos de diseño determinados para cada caso, puede ser necesario dotar algunos movimientos con vías de sentido único, completándola con carriles de aceleración o desaceleración si fuera necesario. Las isletas que se dispongan con este objeto permiten la colocación de las señales adecuadas. Las grandes superficies pavimentadas invitan a los vehículos y peatones a movimientos erráticos, que promueven accidentes y disminuyen la capacidad de la intersección.

- Visibilidad. La velocidad de los vehículos que acceden a la intersección debe limitarse en función de la visibilidad, incluso llegando a la detención total. Entre el punto en que un



conductor pueda ver a otro vehículo con preferencia de paso y el punto de conflicto debe existir, como mínimo, la distancia de parada.

- Perpendicularidad de las trayectorias. Las intersecciones en ángulo recto son las que proporcionan las mínimas áreas de conflicto. Además, disminuyen los posibles choques y facilitan las maniobras, puesto que permiten a los conductores que cruzan juzgar en condiciones más favorables las posiciones relativas de los demás. - previsión. En general, las intersecciones exigen superficies amplias. Esta circunstancia se debe tener en cuenta al autorizar construcciones o instalaciones al margen de la carretera.

(MTC, 2018)

Intersección a desnivel

Esquemas básicos se presentan a continuación, la solución a desnivel frecuentemente utilizados en carreteras.

Figura 4 : Esquema base intersección a desnivel tipo “Trompeta” en carreteras no divididas.

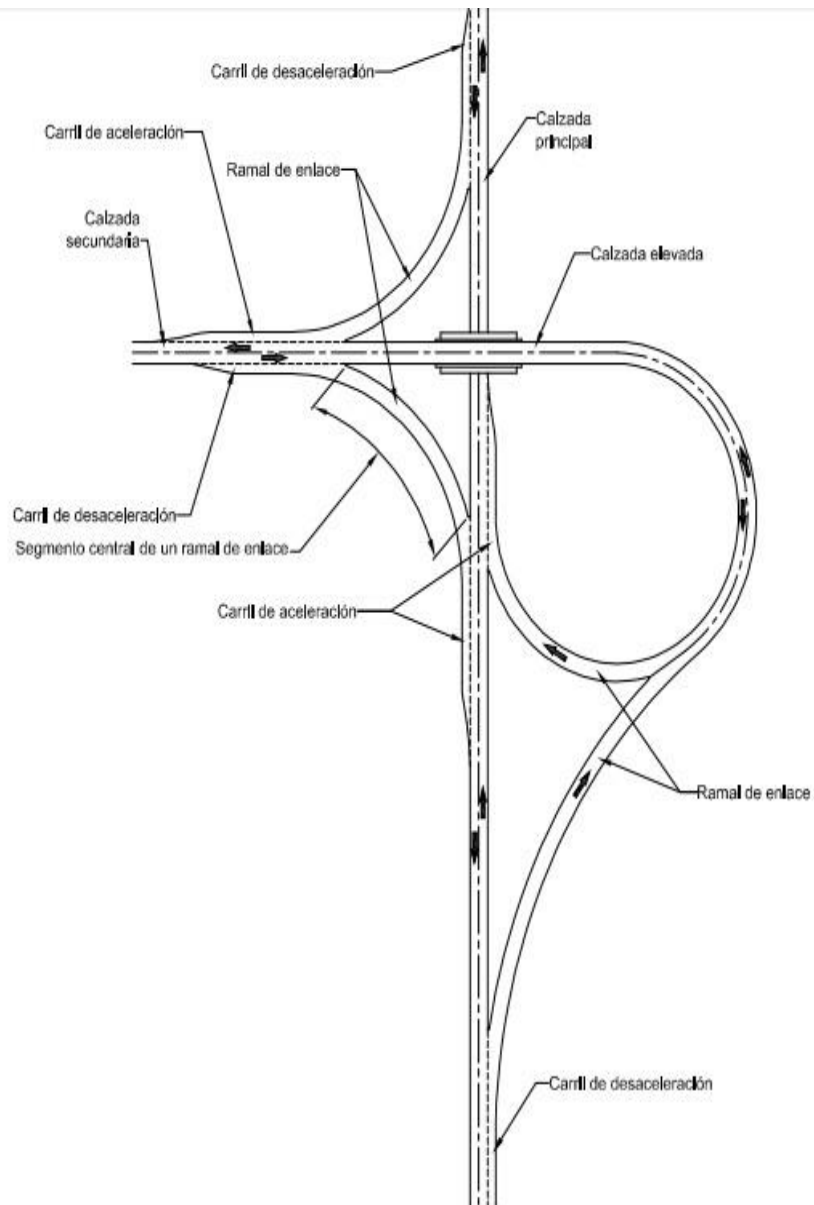

Referencia: (MTC, 2018)



Figura 5: Esquema base intersección a desnivel tipo “Trompeta” en carreteras divididas.

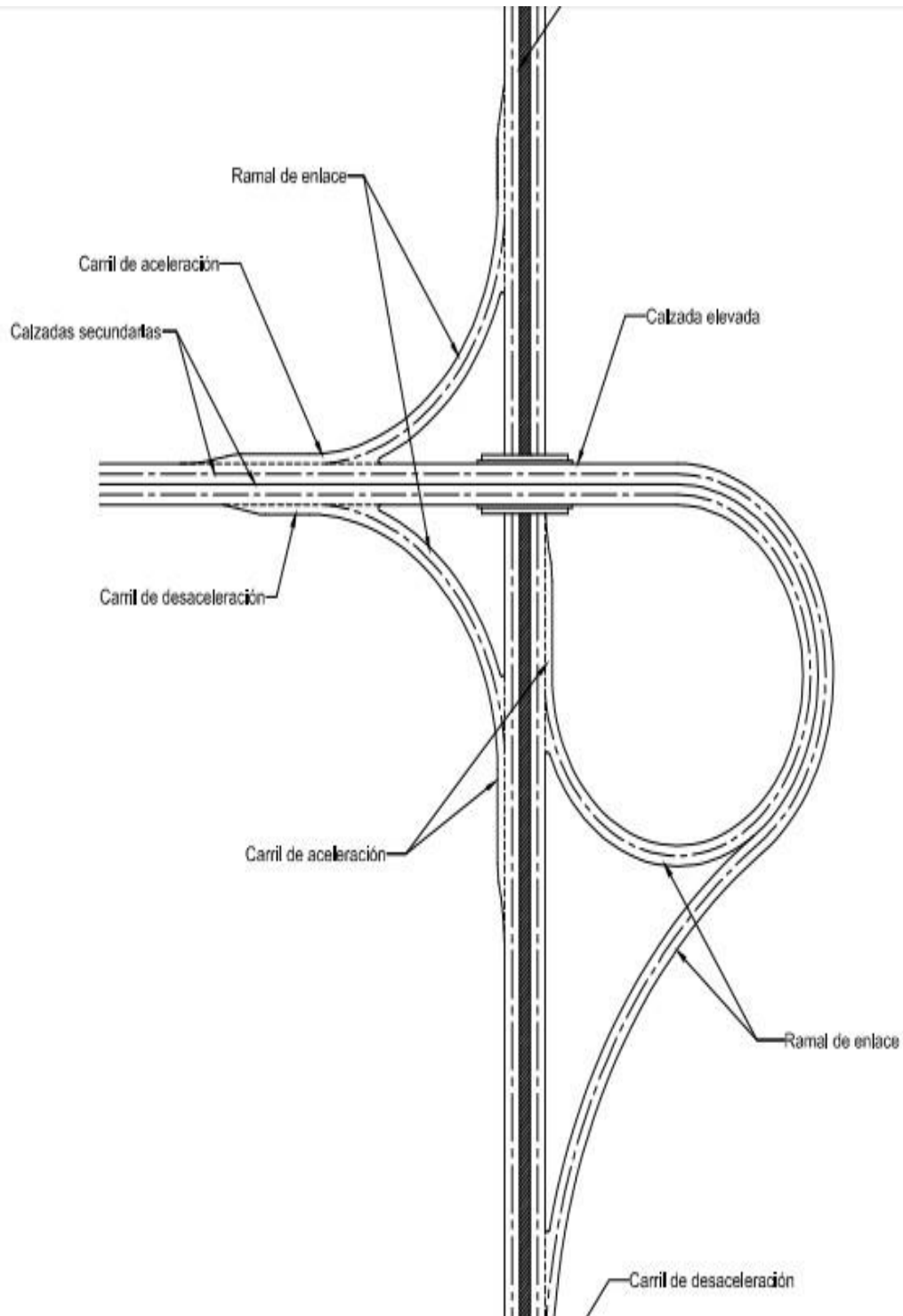

Referencia: (MTC, 2018)



2.3. Hipótesis

2.3.1. Hipótesis general

La congestión y nivel de servicio de las intersecciones del sistema vial entre los óvalos Chambi, Pachacutec y Libertadores no son adecuadas de acuerdo a parámetros de calidad del servicio

Sub – Hipótesis

a) Sub-hipótesis N° 01.

Las condiciones de tráfico influyen en la capacidad vial de las intersecciones que están entre los óvalos Martín Chambi, Pachacutec y Libertadores.

b) Sub-hipótesis N° 02.

Las condiciones geométricas influyen en la capacidad vial de las intersecciones semaforizadas y no semaforizadas entre los óvalos Martín Chambi, Pachacútec y Libertadores.

c) Sub-hipótesis N° 03.

El estado de las condiciones semafóricas influye en la capacidad vial de las intersecciones semaforizadas y no semaforizadas de los óvalos Martín Chambi, Pachacútec y Libertadores

d) Sub-hipótesis N° 04.

La diferencia de los tiempos de demora que influyen en el nivel de servicio semaforizadas y no semaforizadas de los óvalos Martín Chambi, Pachacutec y Libertadores es significativa.

e) Sub-hipótesis N° 05.

Las intersecciones semaforizadas y no semaforizadas entre los óvalos Martín Chambi, Pachacutec y Libertadores tiene una relación de saturación mayor a 0.8

a) Sub-hipótesis N° 06

Es viable elaborar una propuesta de solución para mejorar la circulación vehicular entre los óvalos Martín Chambi, Pachacútec y Libertadores aplicando la metodología del HCM 2010 y simulación.



2.4. Definición de variables

2.4.1. Variables independientes

- Características geométricas.
- Velocidad de Circulación.
- Dispositivos de control.
- Volumen Vehicular
- Volumen Peatonal.

a) Indicadores de variables independientes

- Ancho de carril, longitud de tramo, ancho de berma, tipo de berma, curvatura horizontal.
- Flujo vehicular
- Fases semafóricas, Iluminación, Señales Verticales y Horizontales.
- Volumen Promedio Hora (VPH).

2.4.2. Variables dependientes

- Seguridad Vial.

b) Indicadores de variables dependientes

- Accidentabilidad

2.4.3. Cuadro de operacionalización de variables

Expuesto en la siguiente hoja



CUADRO DE OPERACIONALIZACIÓN DE VARIABLES				
VARIABLES	DESCRIPCIÓN DE LA VARIABLE	INDICADOR	UNIDAD	INSTRUMENTOS
DEPENDIENTE				
NIVELES DE SERVICIO	Conjunto de acciones orientadas al calculo del nivel de satisfacción del usuario y conductores.	Demoras	Segundo/veh	Fichas policiales Listas de chequeo
INDEPENDIENTE				
CARACTERÍSTICAS GEOMÉTRICAS	Capacidad de la vía, con el tipo de vehículos que circulan por ella y con la velocidad de circulación .características de la vía que han sido diseñadas siguiendo una normativa referente a sus dimensiones y propiedades.	Ancho de carril Longitud de tramo Ancho de berma Curvas Horizontales Curvas Verticales	Metro, kilometro	Levantamiento Topográfico Guías de observación Wincha
VELOCIDAD VEHICULAR	Relación entre la distancia recorrida por un móvil y el tiempo que ha tardado en recorrerla	Velocidad de punto Velocidad media Visibilidad	Km/h Km/h m	Guías de observación
DISPOSITIVOS DE CONTROL	Se denomina las señales, marcas, semáforos y cualquier otro dispositivo, que se colocan sobre o adyacente a las calles y carreteras por una autoridad pública, para prevenir, regular y guiar a los usuarios de las mismas.	Señalización horizontal Señalización vertical Iluminación Cantidad de semáforos	Bueno Regular Malo Unidad Ubicación	Guías de observación, Wincha, Check list
VOLUMEN VEHICULAR Y PEATONAL	Consisten básicamente en conocer los vehículos que pasan por un punto de una carretera, para obtener información sobre los viajes que realizan, principalmente sobre su origen y su destino. Consisten básicamente en conocer la cantidad de patones que pasan por un punto en una vía en una unidad de tiempo.	Veh/hr Peatones/hr	Número de Vehículos Número de personas	Guías de aforo vehicular Guías de aforos

Fuente: Elaboración propia



Capítulo III: Metodología

1. Metodología de la Investigación

3.1. Tipo de Investigación

“El enfoque cuantitativo utiliza la recolección de datos para probar hipótesis, con base en la medición numérica y el análisis estadístico, para establecer patrones de comportamiento y probar teorías” (Hernández Sampieri, Fernández Collado, & Baptista Lucio, 2014, pág. 4).

Esta investigación es de tipo cuantitativa, según el método del Manual de Seguridad Vial MSV -2017, Inspección de Seguridad Vial, ya que se tienen limitaciones de gestión de movilidad, Seguridad del usuario. De igual manera el análisis cuantitativo permitirá plantear las propuestas de solución en los puntos de mayor índice de accidentabilidad.



Figura 6: Proceso cuantitativo

Fuente: Metodología de investigación (Hernández Sampieri, Fernández Collado, & Baptista Lucio, 2014)

3.1.1. Nivel o alcance de la investigación:

El alcance de la investigación es caracterizado como descriptivo ya que “busca especificar propiedades y características importantes de cualquier fenómeno que se analice” (Hernández Sampieri, Fernández Collado, & Baptista Lucio, 2014)

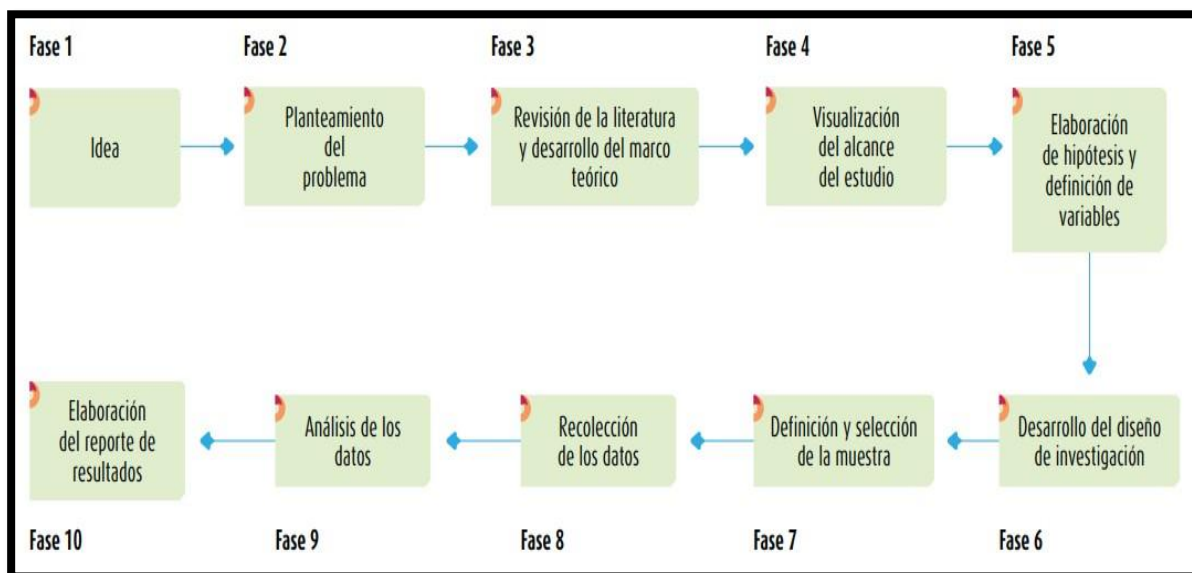
En este caso es el análisis de la Seguridad Vial en la Vía de Evitamiento aplicando una Inspección de Seguridad Vial.



3.1.2. Método de Investigación:

El método establecido para la investigación será el Hipotético-Deductivo, el cual “Consiste en un procedimiento que parte de unas aseveraciones en calidad de hipótesis y busca refutar o falsear tales hipótesis, deduciendo de ellas conclusiones que deben confrontarse con los hechos” (Bernal, 2010).

En la presente investigación se plantearán hipótesis, las cuales se comprobará su veracidad o falsedad, sustentada con los resultados de procesos deductivos relacionados con las variables que serán cuantificadas mediante sus indicadores.

3.2. Diseño de la Investigación

3.2.1. Diseño Metodológico:

Para el desarrollo de esta investigación se utilizaron, primero un diseño NO EXPERIMENTAL en su forma LONGITUDINAL en una etapa de recopilación de datos y primer análisis tanto con la Metodología del Manual de Seguridad Vial.

La propuesta no fue empleada u simulada en campo, se espera en un futuro cercano sea implementada en campo, ya que se obtuvo resultados del análisis gracias a fichas de inspección que ayudaron a llegar a alternativas de solución las cuales son planteadas en fichas.

El diseño no experimental es la que se realiza sin la manipulación deliberada de variables y en los que sólo se observan los fenómenos en su ambiente natural para después analizarlos. (Hernández Sampieri, Fernández Collado, & Baptista Lucio, 2014)

Los diseños longitudinales recaban datos en diferentes puntos del tiempo, para realizar inferencias acerca de la evolución, sus causas y sus efectos.



3.2.2. Diseño de ingeniería

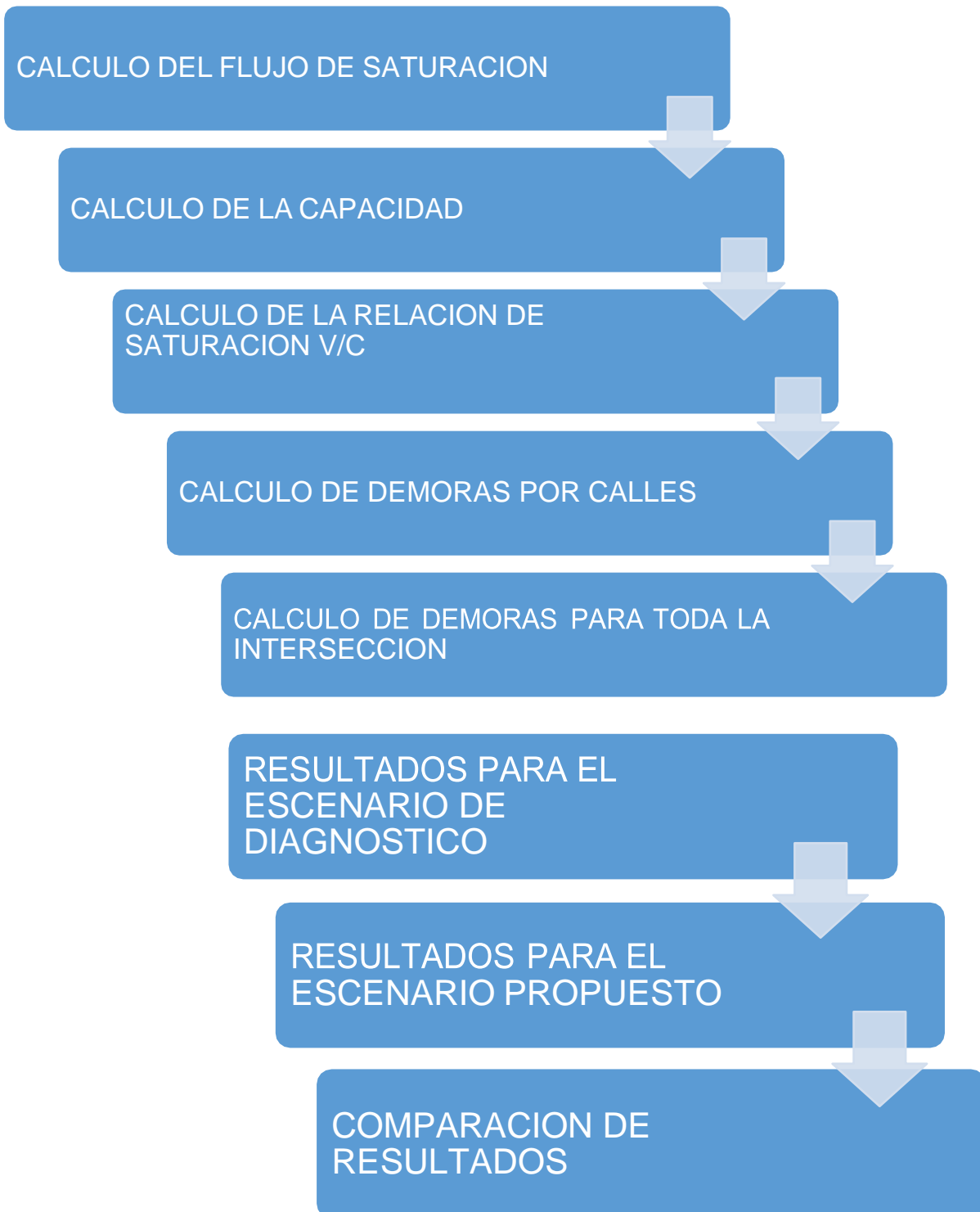



3.3. Población y Muestra

3.3.1. Población

3.3.1.1. Descripción de la Población

Se define población como el conjunto de todos los elementos que comparten características similares, que representa el universo para el propósito del problema de investigación.

La Población de esta investigación son el conjunto de intersecciones de las diferentes vías arteriales de la Ciudad del Cusco, las cuales por ser intersecciones importantes con un alto grado de accidentabilidad deben de ser estudiados y analizados (Fichas de Inspección Vial, levantamiento topográfico).

3.3.1.2. Cuantificación de la Población

La población son las intersecciones siguientes:

- Intersección 01 - Av. Ejército y Av. San Martín
- Intersección 02 - Av. Confraternidad y Av. San Martín
- Intersección 03 – Ovalo Pachacutec y Av. San Martín
- Intersección 04 – Ovalo Pachacutec y Av. Sucre
- Intersección 05 – Ovalo Pachacutec y Av. Vallejos Santoni
- Intersección 06 – Ovalo Pachacutec y Acceso Terminal
- Intersección 07 – Ovalo Pachacutec y Av. 28 de Julio
- Intersección 08 – Ovalo Pachacutec y Av. La Paz
- Intersección 09 – Ovalo Pachacutec y Av. Infancia
- Intersección 10 – Av. 28 de Julio y Jr. Los Sauces
- Intersección 10 – Av. 28 de Julio y Av. Qosqo/Vía Expresa

3.3.2. Muestra

3.3.2.1. Descripción de la Muestra

La muestra seleccionada para esta investigación fueron las intersecciones con más conflicto vehicular de las vías arteriales en la ciudad del Cusco. Es una muestra censal ya que la muestra coincide con la población.

En este sentido Ramírez (1997) afirma “La muestra central es aquella donde todas las unidades de investigación son consideradas como muestra”

3.3.2.2. Cuantificación de la Muestra:

La muestra de la investigación coincide con la población anteriormente establecida.



3.3.2.3. Método de Muestreo

El método de muestreo que se optó es NO PROBABILISTICO, en el cual se aplicó la SELECCIÓN DELIBERADA de las intersecciones que no cuentan con sistemas de control vial (señalización, semaforización), donde se encontró falencias que causan accidentes constantemente.

3.3.2.4. Criterios de Evaluación de Muestra

Son intersección sin sistemas de control vial, con un tráfico alto de peatones y vehículos, con potencial problemas de accidentes.

3.3.3. Criterios de Inclusión

Son el conjunto de propiedades y características cuyo cumplimiento identifica a la carretera analizada. Su objetivo es delimitar la población y muestra de la investigación. Los criterios a considerar son:

- Intersecciones no semaforizadas
- Intersecciones semaforizadas
- Segmentos de vía entre intersecciones

3.4. Instrumentos

3.4.1. Instrumentos Metodológicos o Instrumentos de Recolección de Datos



FORMATO DE ENTRADA											
UNIVERSIDAD/FACULTAD	UNIVERSIDAD ANDINA DEL CUSCO ESCUELA PROFESIONAL DE INGENIERÍA CIVIL	FECHA				CONDICIONES GEOMETRICAS Y DE CIRCULACION					
INTERSECCION		AREA									
PROYECTO					ACCESO HACIA EL	NUMERO DE CARRIL	ANCHO CARRIL (m)	V. PESADOS (veh)	GIROS IZQ. (veh)	LONGITUD DE COLA (VEH.)	TIPO DE LLEGADA
	NORTE										
	SUR										
	ESTE										
	OESTE										
ACCESO HACIA EL	PENDIENTE (%)	ESTACIONAMIENTO		PARADEROS		FLUJO PEATONAL					
	E (%)	S o N	Nm	S o N	Autobuses						
NORTE											
SUR											
ESTE											
OESTE											

Fuente: Propia

	UNIVERSIDAD ANDINA DEL CUSCO					
	ESCUELA PROFESIONAL DE INGENIERÍA CIVIL					
ACCESO HACIA EL	MOV.	CICLO SEMAFÓRICO				
		VERDE	AMBAR	ALL RED	PERMITIDO	EXCLUSIVO
NORTE						
SUR						
ESTE						
OESTE						

Fuente: Propia



3.4.2. Instrumentos de ingeniería

1.1.1.1. Software SYNCHRO educacional:

Instrumento utilizado para realizar la simulación de transporte en las intersecciones de estudio.



Para la recolección de datos del levantamiento topográfico e inspección de las intersecciones analizadas en campo, se hicieron uso de los siguientes equipos. Expuesto en la siguiente página.

Tabla 2: *Instrumentos de ingeniería*



INSTRUMENTOS DE INGENIERÍA		
INSTRUMENTO	DEFINICIÓN	IMAGEN Y/O INSTRUMENTO
ESTACION TOTAL	aparato electro-óptico utilizado en topografía, cuyo funcionamiento se apoya en la tecnología electrónica. Consiste en la incorporación de un distanciómetro y un microprocesador a un teodolito electrónico.	
PORTA PRISMA	Es un aparato, empleado para medición en topografía, de forma circular que se encuentra constituido por un conjunto de cristales. Así, la función que cumple dichos cristales es la de proyectar la señal EMD que produce un teodolito electrónico o una estación total.	
TRIPODE	Base que sirve de apoyo a la estación total	
CINTA MÉTRICA	Cinta reforzada con fibra de vidrio para mediciones precisas.	
CÁMARA	Instrumento para registrar fotografías de los componentes de la inspección de seguridad vial	
GPS	Son receptores que registran el recorrido, permiten seguir rutas premarcadas, y se pueden conectar a un ordenador para descargar o programar las rutas.	
AUTOCAD CIVIL 3D	Software utilizado para procesar los datos obtenidos por la estación total en el levantamiento topográfico	



3.5. Procedimientos de Recolección de Datos.

1.1.2. Codificación de la geometría



Figura 7. Nodo 1



Figura 8. Nodo 2

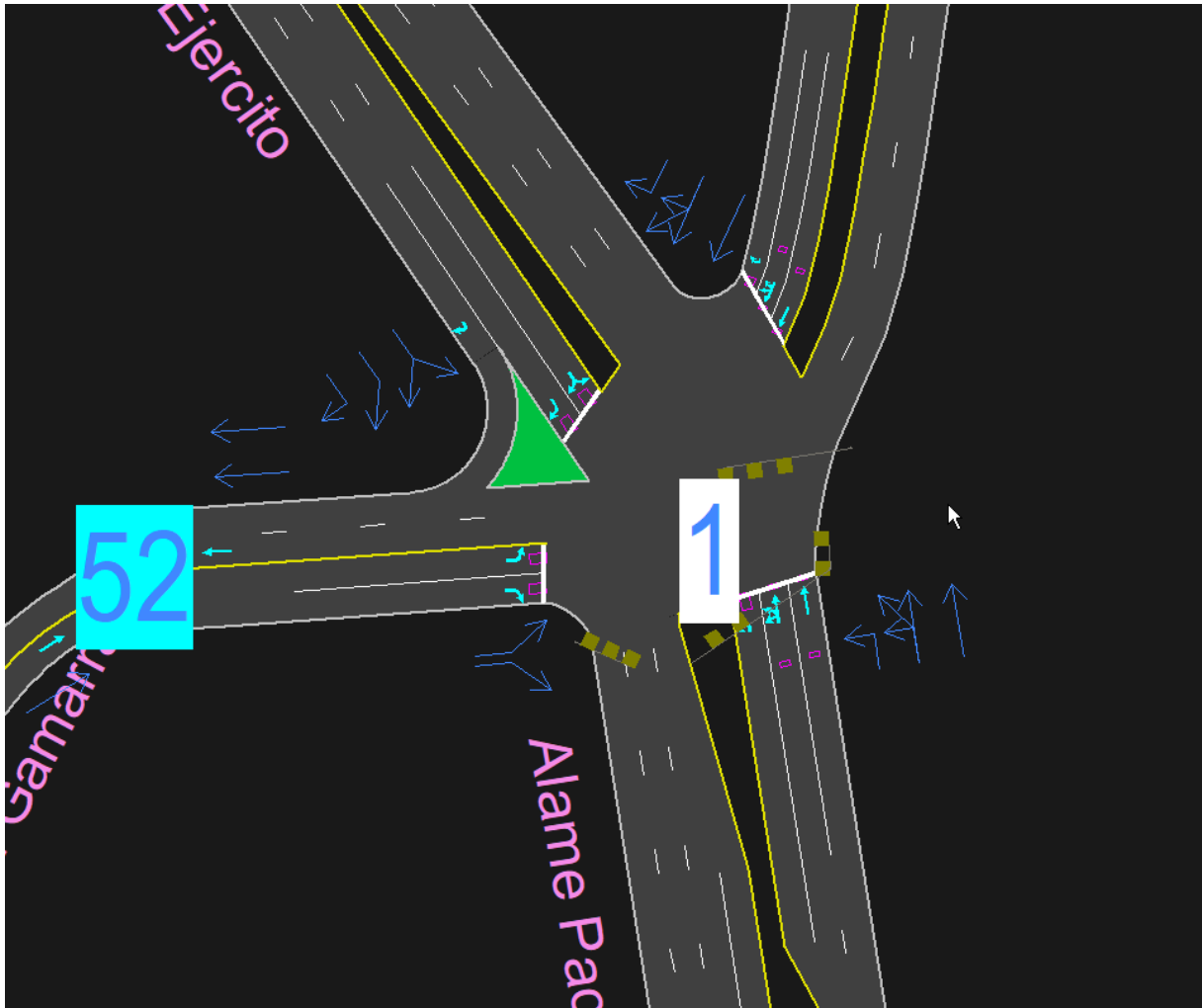

Figura 9. Nodo 3

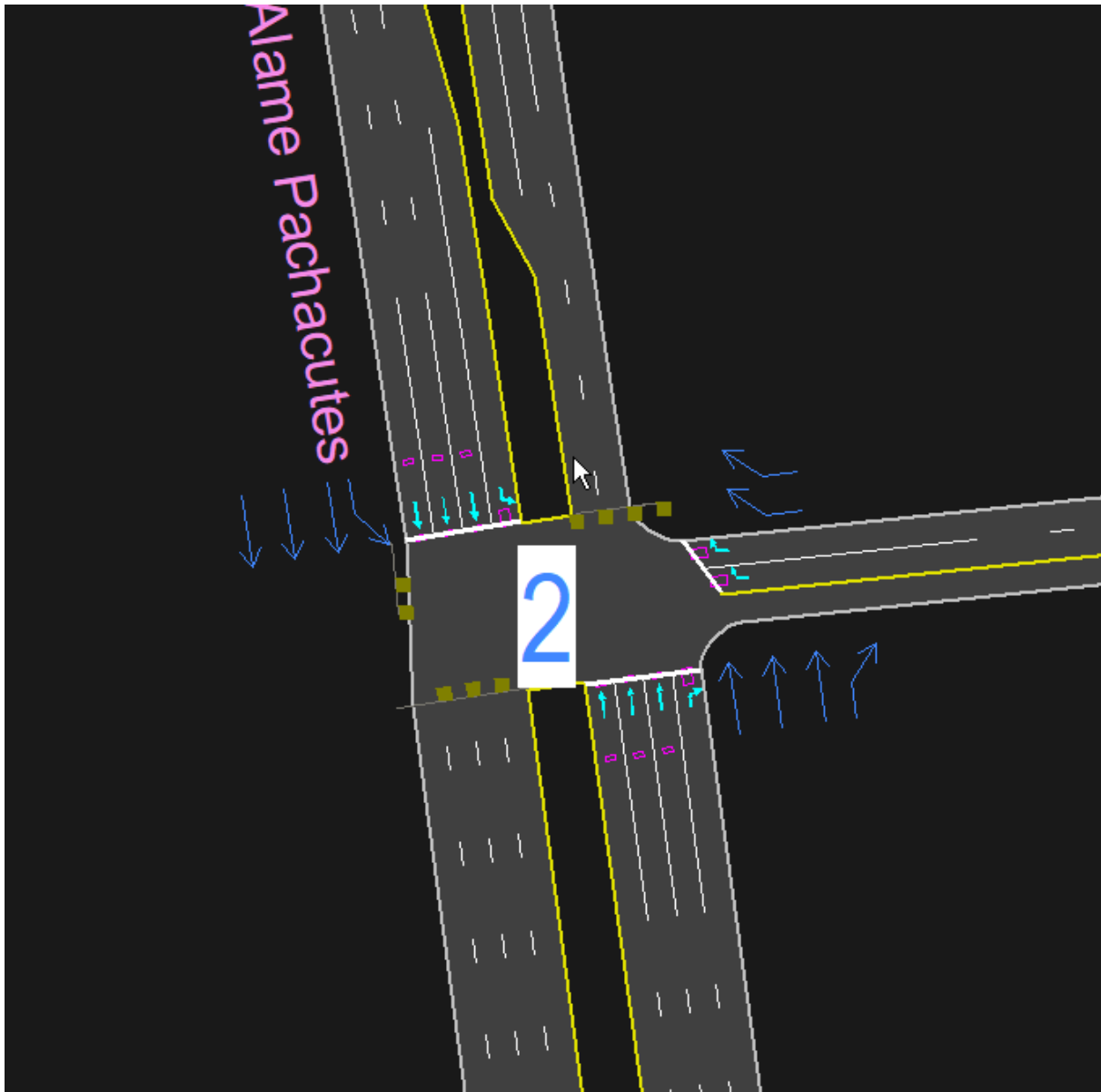

Figura 10. Nodo 4

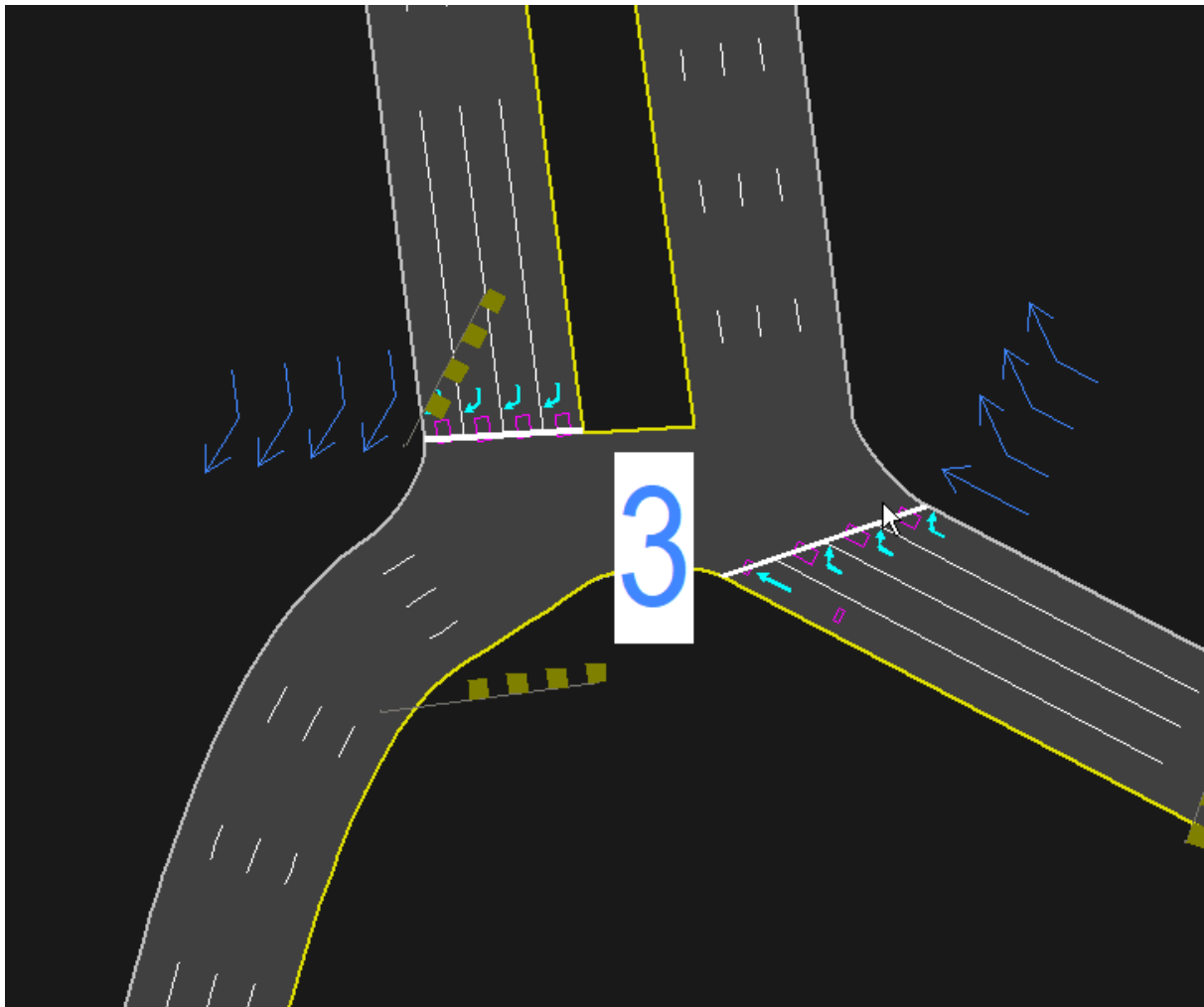

Figura 11. Nodo 5

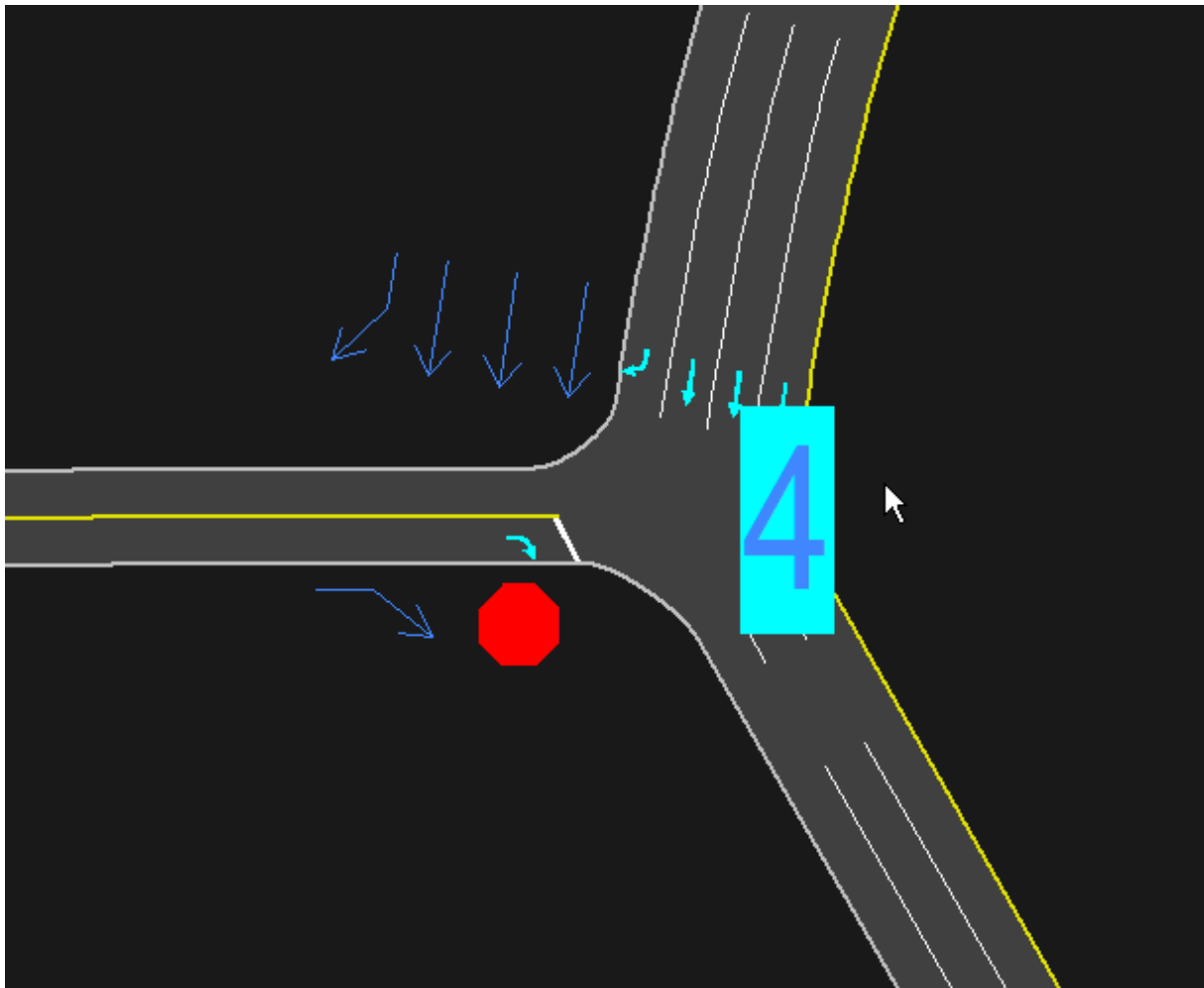

Figura 12. Nodo 6

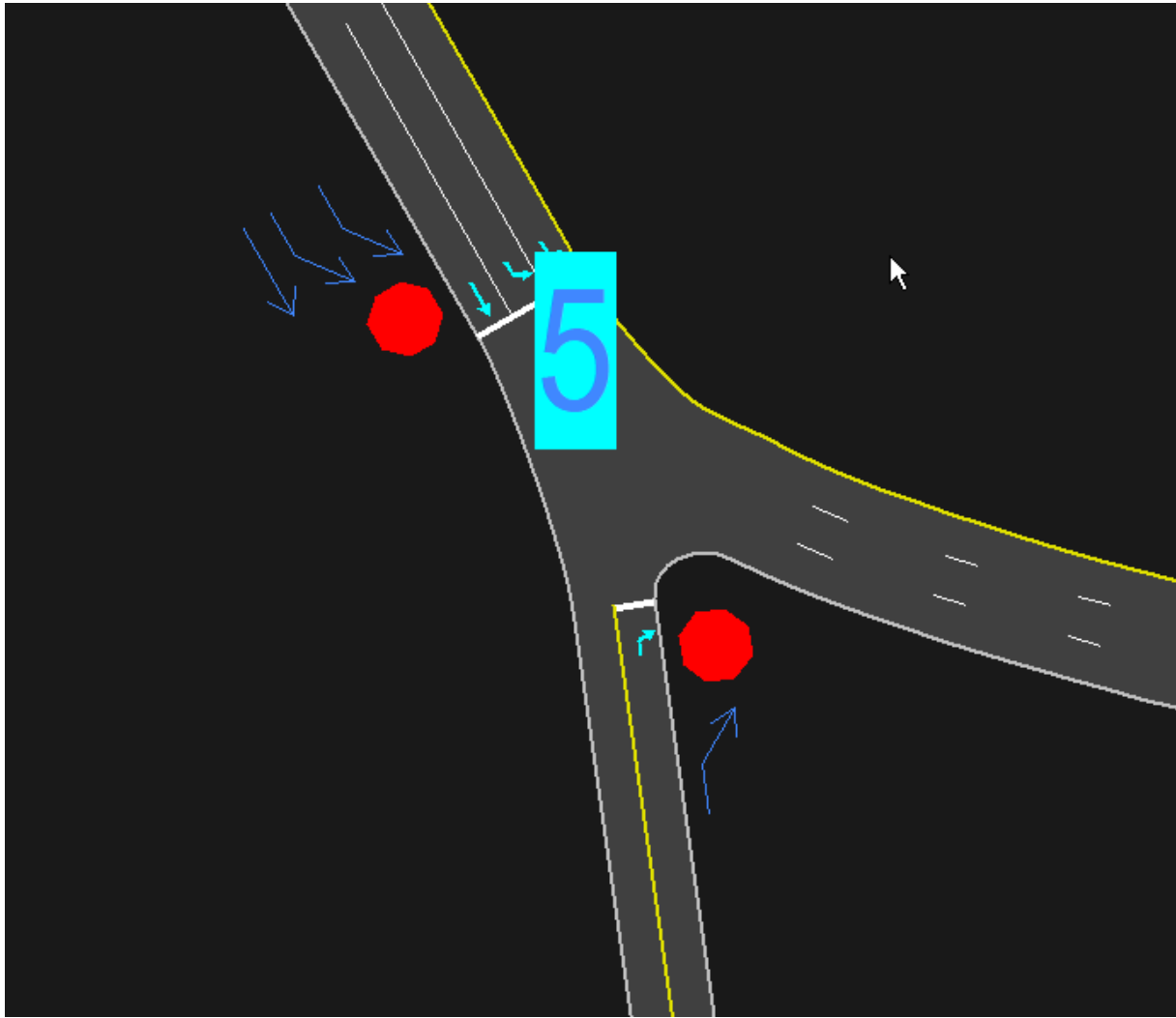

Figura 13. Nodo 7

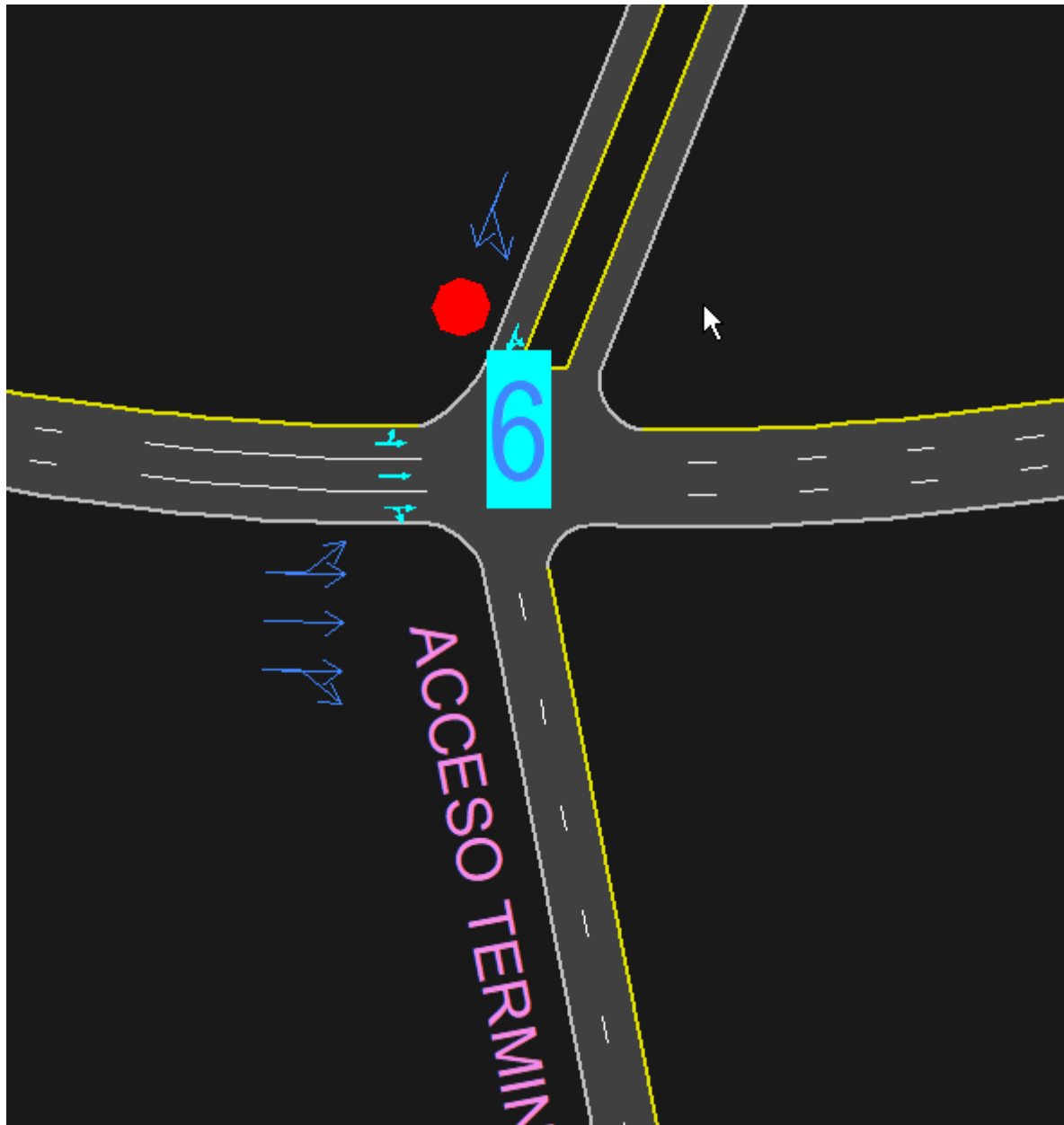

Figura 14. Nodo 8

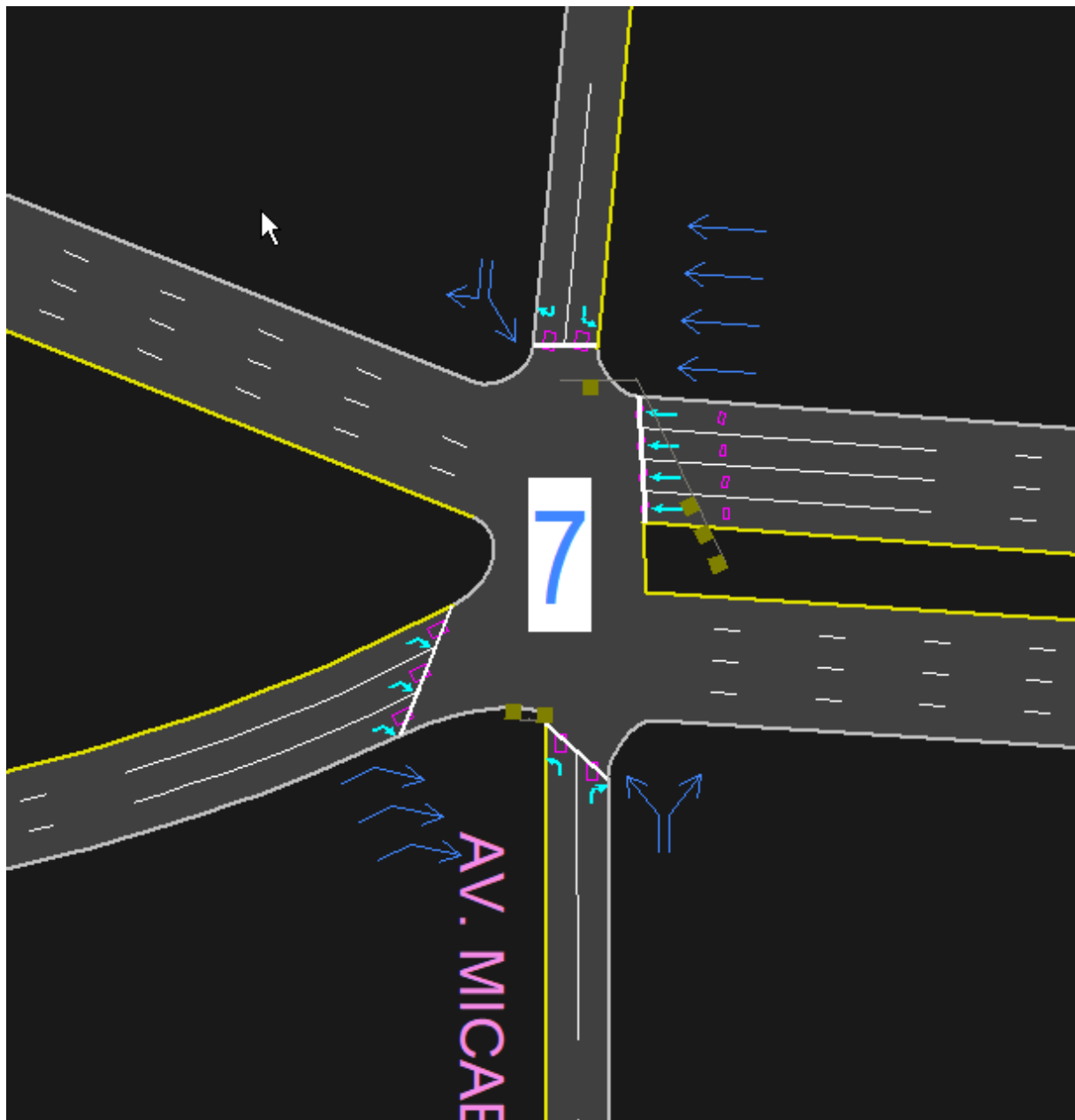

Figura 15. Nodo 9

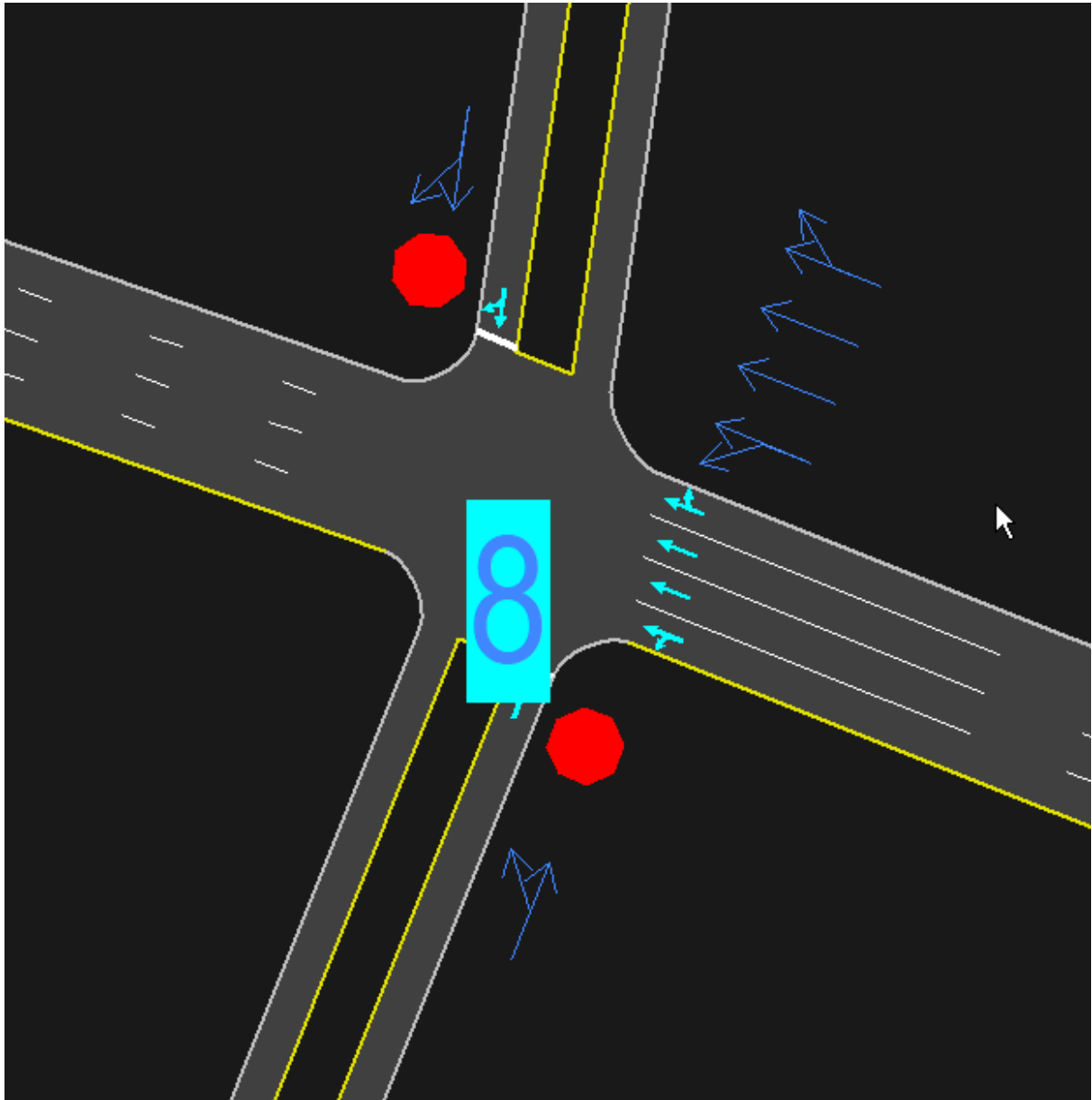

Figura 16. Nodo 10

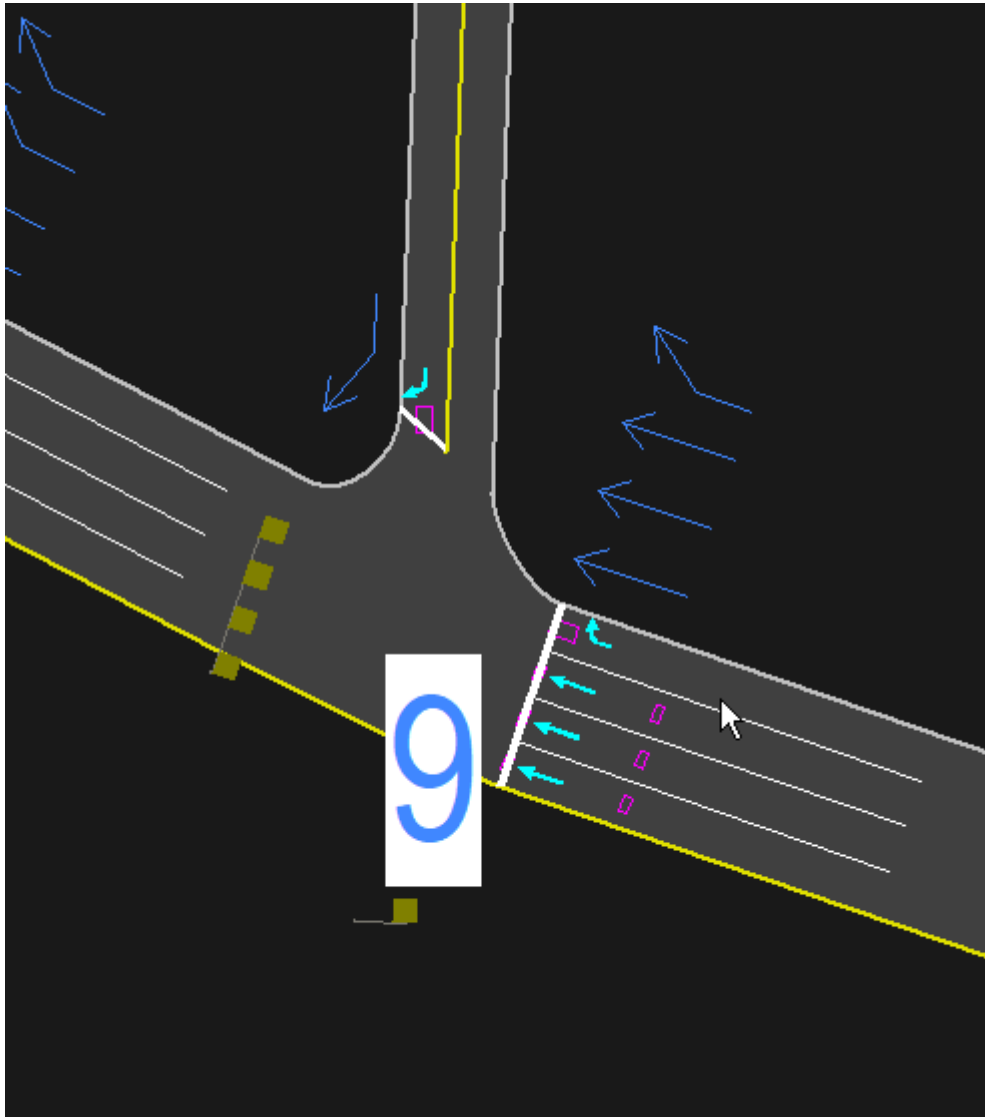

Figura 17. Nodo 11

Tabla 3. Configuración de la geometría, anchos de carril y velocidad en las vías

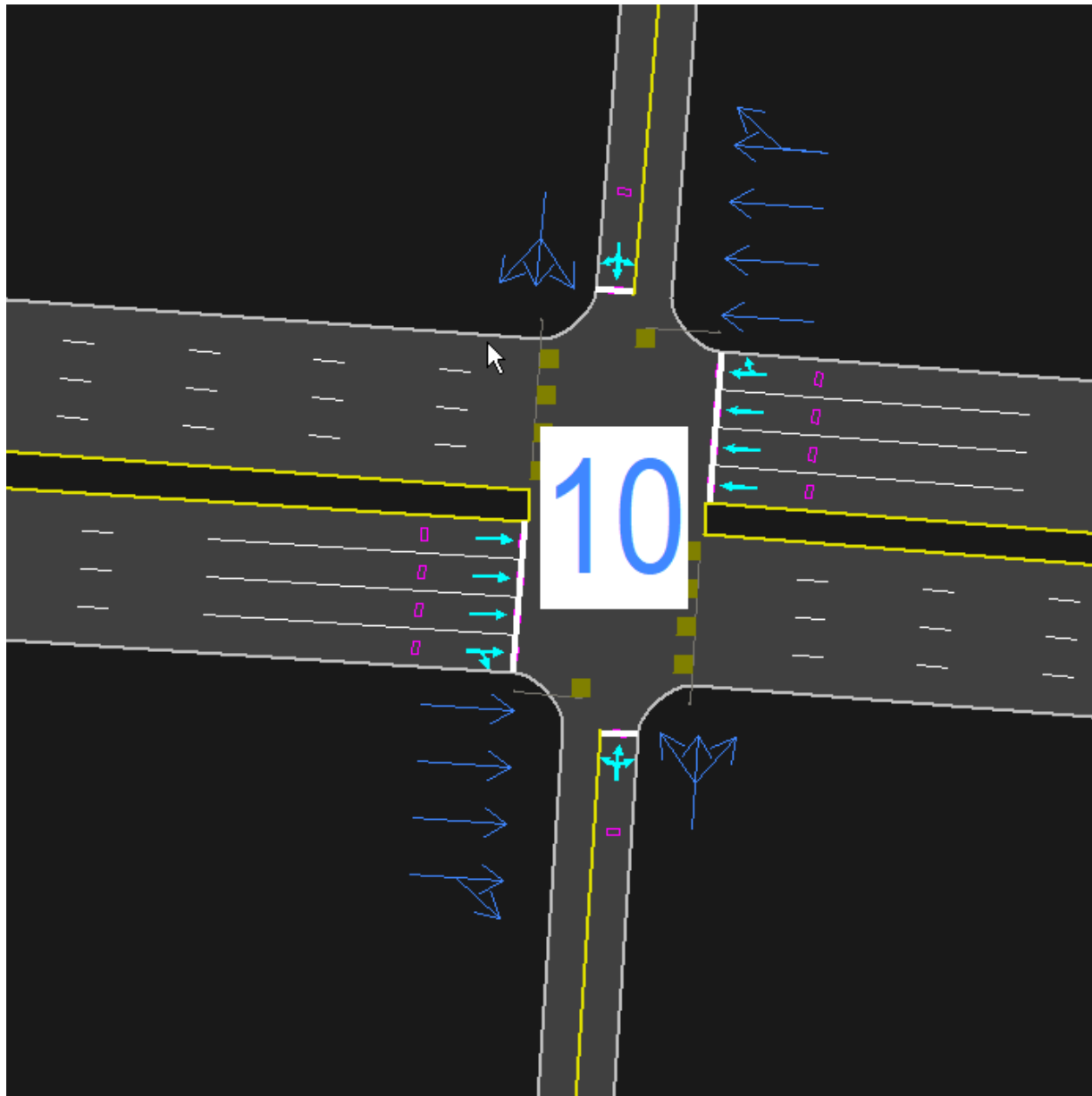
LANE SETTINGS	←			↑			→			↓		
	EBL2	EBL	EBR	NBL2	NBL	NBT	SBT	SBR	SBR2	SEL	SER	SER2
Lanes and Sharing (#RL)		↗	↘	↗	↘	↕	↕	↙	↘	↙	↘	↕
Traffic Volume (vph)	0	444	698	130	840	1399	0	212	756	76	1501	76
Street Name	AV. SAN MARTIN						Av. Ejercito					
Link Distance (m)	—	69.3	—	—	—	100.4	313.3	—	—	152.6	—	—
Links Speed (km/h)	—	50	—	—	—	50	50	—	—	50	—	—
Set Arterial Name and Speed	EB			NB			SB	SE			—	
Travel Time (s)	—	5.0	—	—	—	7.2	22.6	—	—	11.0	—	—
Ideal Satd. Flow (vphpl)	1900	1900	1900	1900	1900	1900	1900	1900	1900	1900	1900	1900
Lane Width (m)	3.6	3.6	3.6	3.6	3.6	3.6	2.7	2.7	2.7	3.6	3.6	3.6
Grade (%)	—	0	—	—	—	0	0	—	—	0	—	—
Area Type CBD	—	<input type="checkbox"/>	—	—	—	<input type="checkbox"/>	<input type="checkbox"/>	—	—	<input type="checkbox"/>	—	—
Storage Length (m)	—	0.0	0.0	—	40.0	—	—	0.0	—	0.0	0.0	—
Storage Lanes (#)	—	—	—	—	1	—	—	—	—	—	—	—
Right Turn Channelized	—	—	None	—	—	None	—	—	None	—	—	Free
Curb Radius (m)	—	—	—	—	—	—	—	—	—	—	—	10.0
Add Lanes (#)	—	—	—	—	—	—	—	—	—	—	—	0

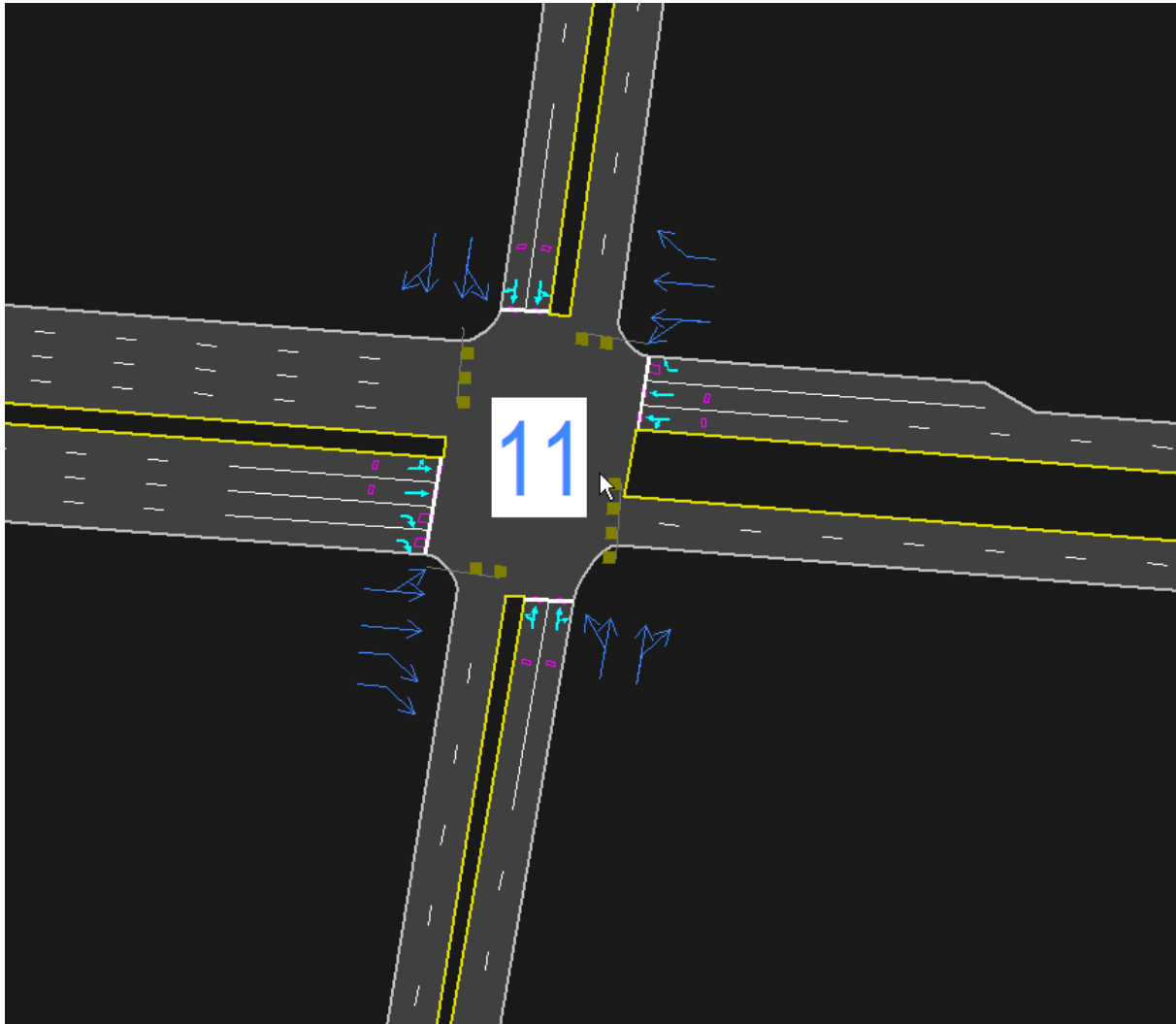

1.1.3. Volúmenes vehiculares

Tabla 4. Configuración de la demanda vehicular, factor de hora punta, factor de crecimiento, porcentaje de vehículos pesados, parqueos y estacionamientos.

VOLUME SETTINGS												
	EBL2	EBL	EBR	NBL2	NBL	NBT	SBT	SBR	SBR2	SEL	SER	SER2
Lanes and Sharing (#/RL)												
Traffic Volume (vph)	0	444	698	130	840	1399	0	212	756	76	1501	76
Conflicting Peds. (#/hr)	0	0	0	0	0	—	—	0	0	0	0	0
Conflicting Bicycles (#/hr)	—	—	0	—	—	—	—	0	0	—	0	0
Peak Hour Factor	0.92	0.92	0.92	0.92	0.92	0.92	0.92	0.92	0.92	0.92	0.92	0.92
Growth Factor	1.00	1.00	1.00	1.00	1.00	1.00	1.00	1.00	1.00	1.00	1.00	1.00
Heavy Vehicles (%)	2	2	2	2	2	2	2	2	2	2	2	2
Bus Blockages (#/hr)	0	0	0	0	0	0	0	0	0	0	0	0
Adj. Parking Lane?	<input type="checkbox"/>	<input type="checkbox"/>	<input type="checkbox"/>	<input type="checkbox"/>	<input type="checkbox"/>	<input type="checkbox"/>	<input type="checkbox"/>	<input type="checkbox"/>	<input type="checkbox"/>	<input type="checkbox"/>	<input type="checkbox"/>	<input type="checkbox"/>
Parking Maneuvers (#/hr)	—	—	—	—	—	—	—	—	—	—	—	—
Traffic from mid-block (%)	—	0	—	—	—	0	0	—	—	0	—	—
Link OD Volumes	—	—	—	—	—	NB	—	—	—	—	—	—
Adjusted Flow (vph)	0	483	759	141	913	1521	0	230	822	83	1632	83
Traffic in shared lane (%)	—	—	—	10	—	—	—	—	50	—	48	—
Lane Group Flow (vph)	0	483	759	127	0	2448	641	0	411	866	849	83



Figura 18. Nodo 1



Figura 19. Nodo 2

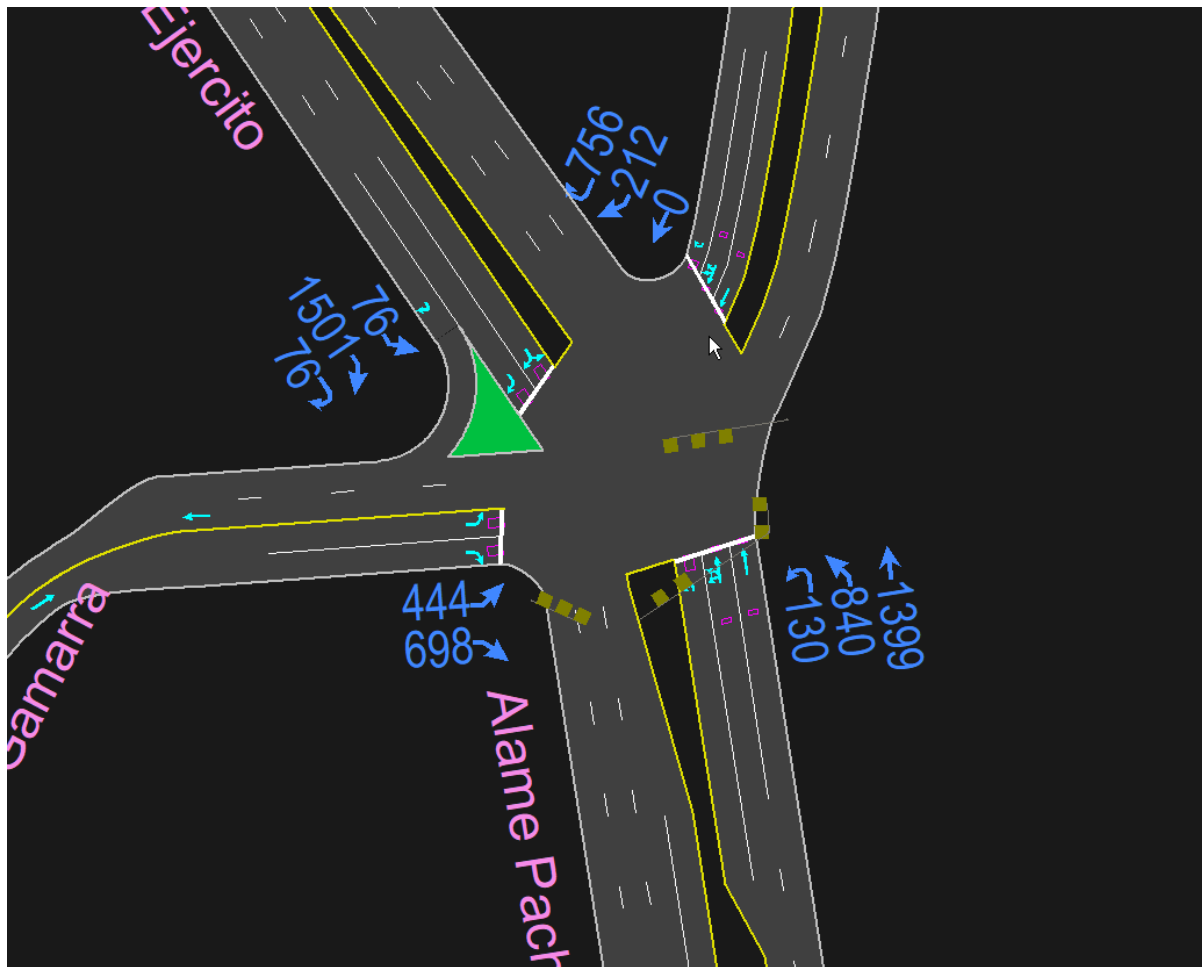

Figura 20. Nodo 3

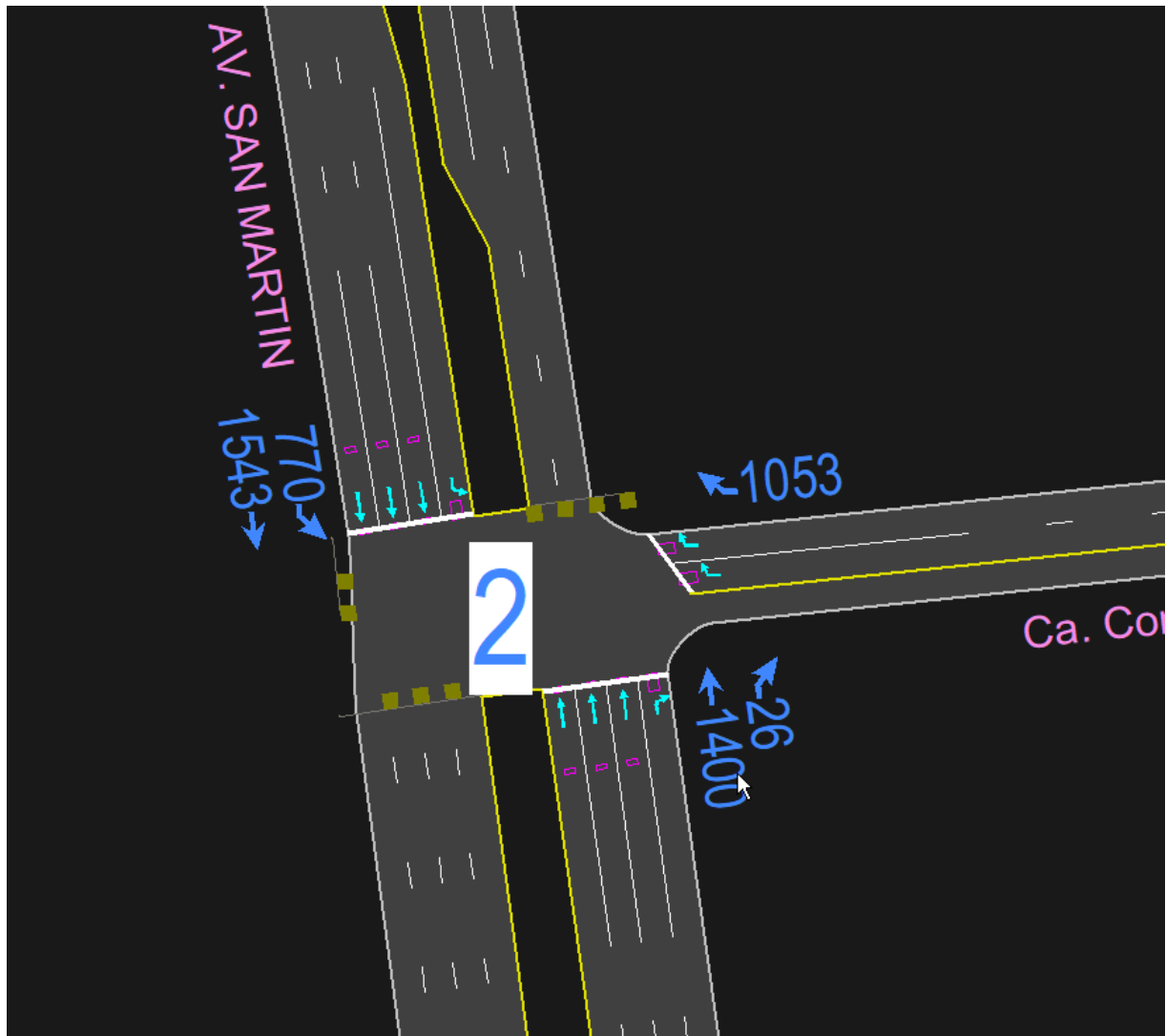

Figura 21. Nodo 4

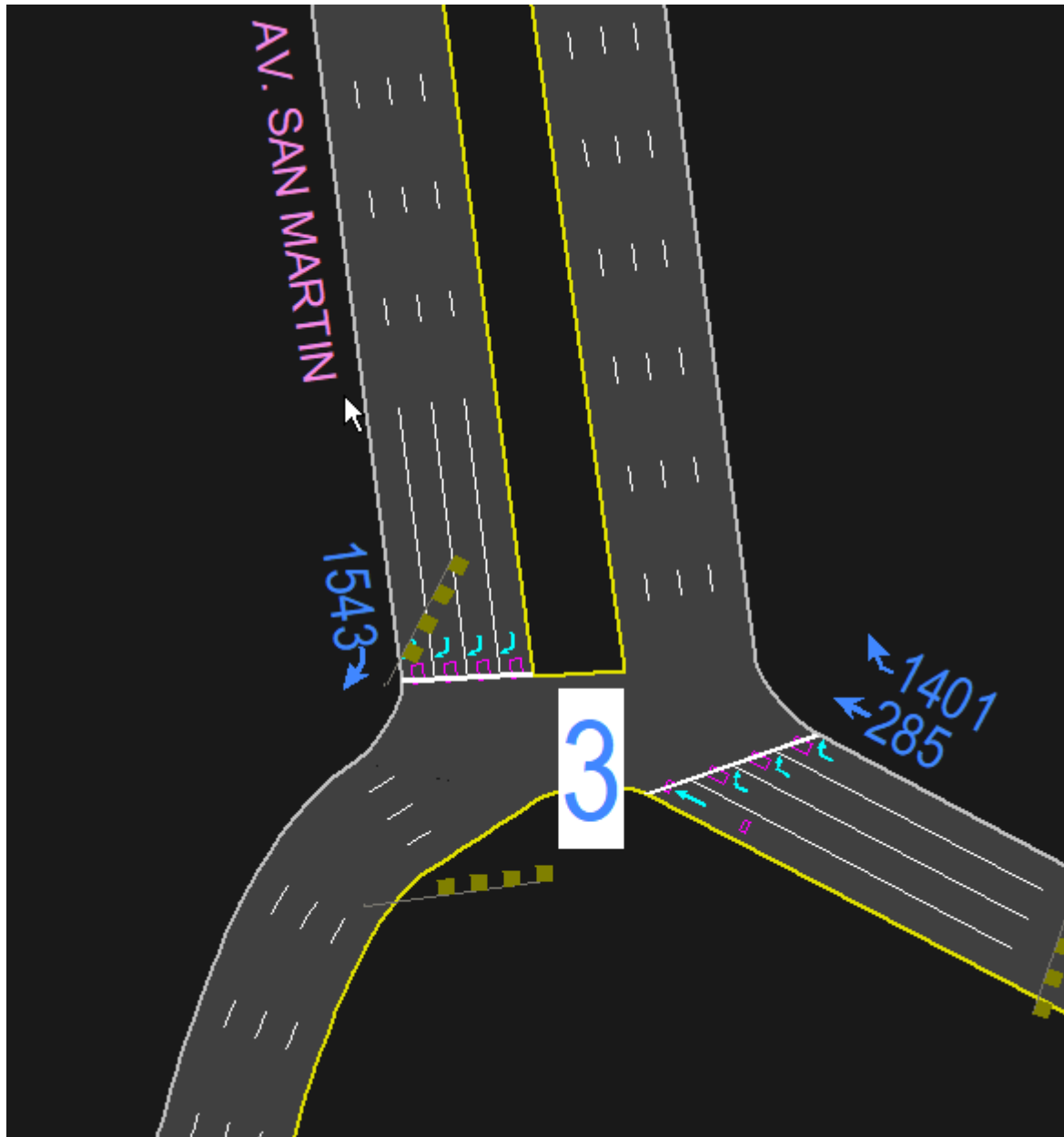

Figura 22. Nodo 5

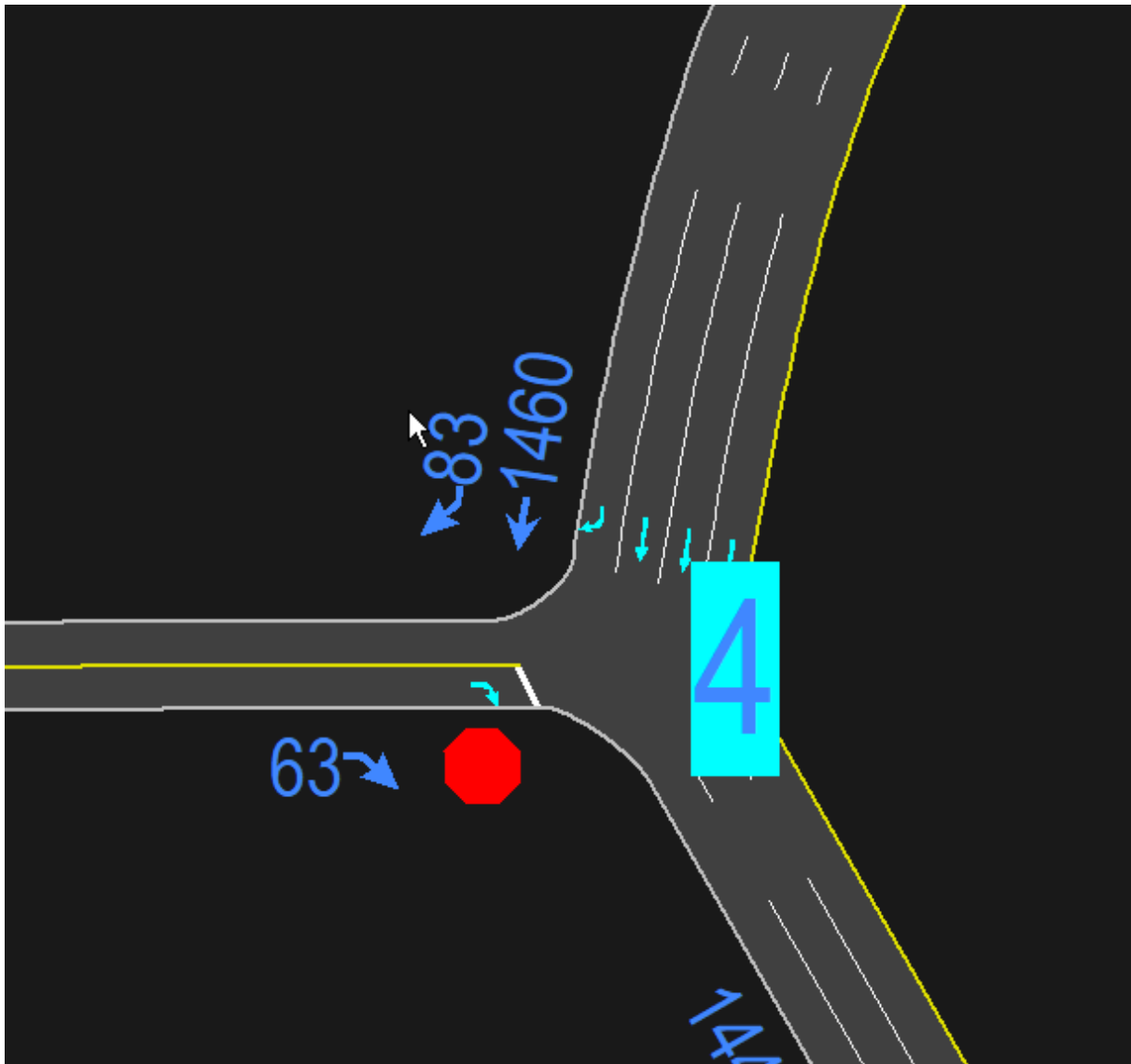

Figura 23. Nodo 6

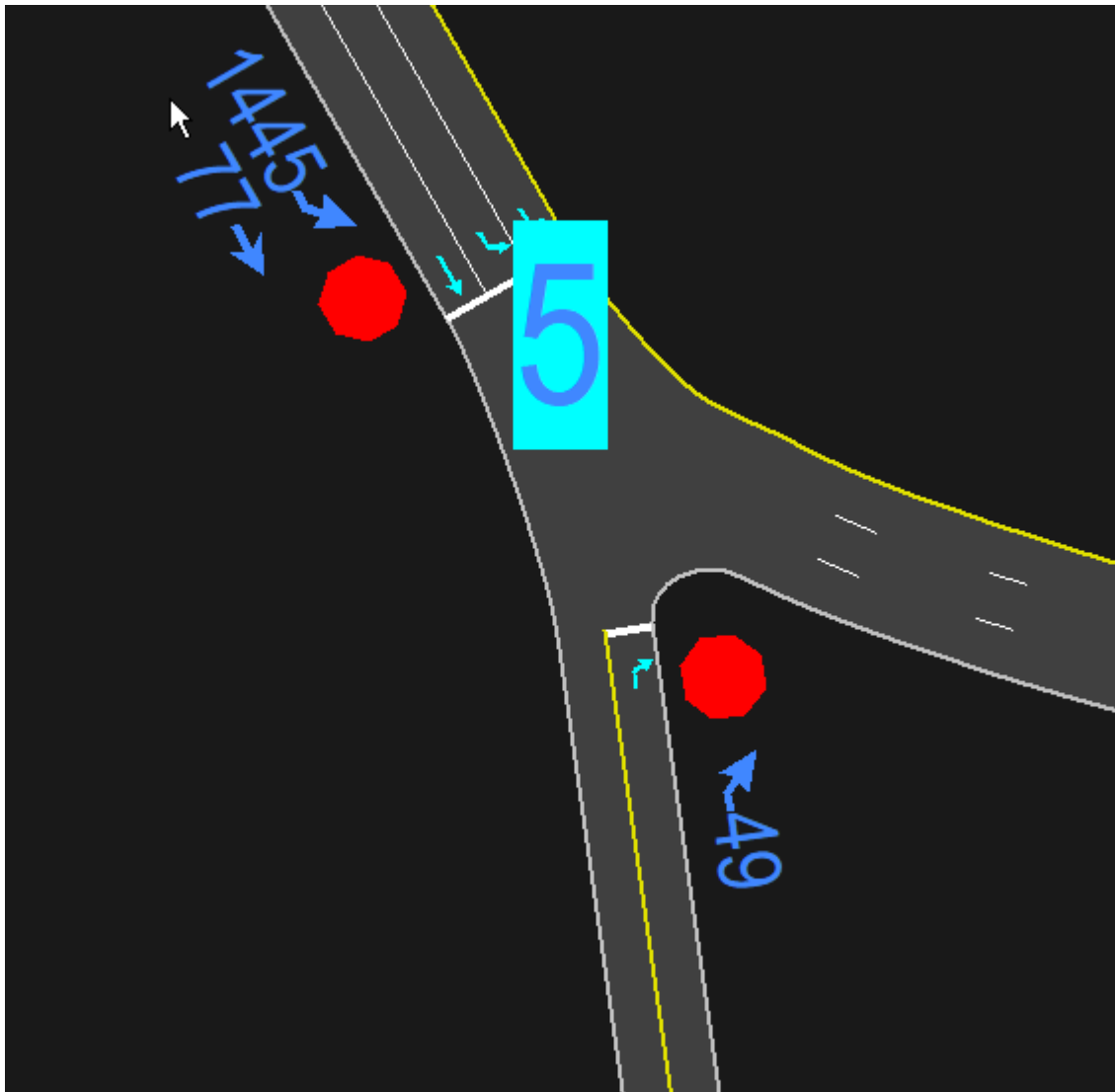

Figura 24. Nodo 7

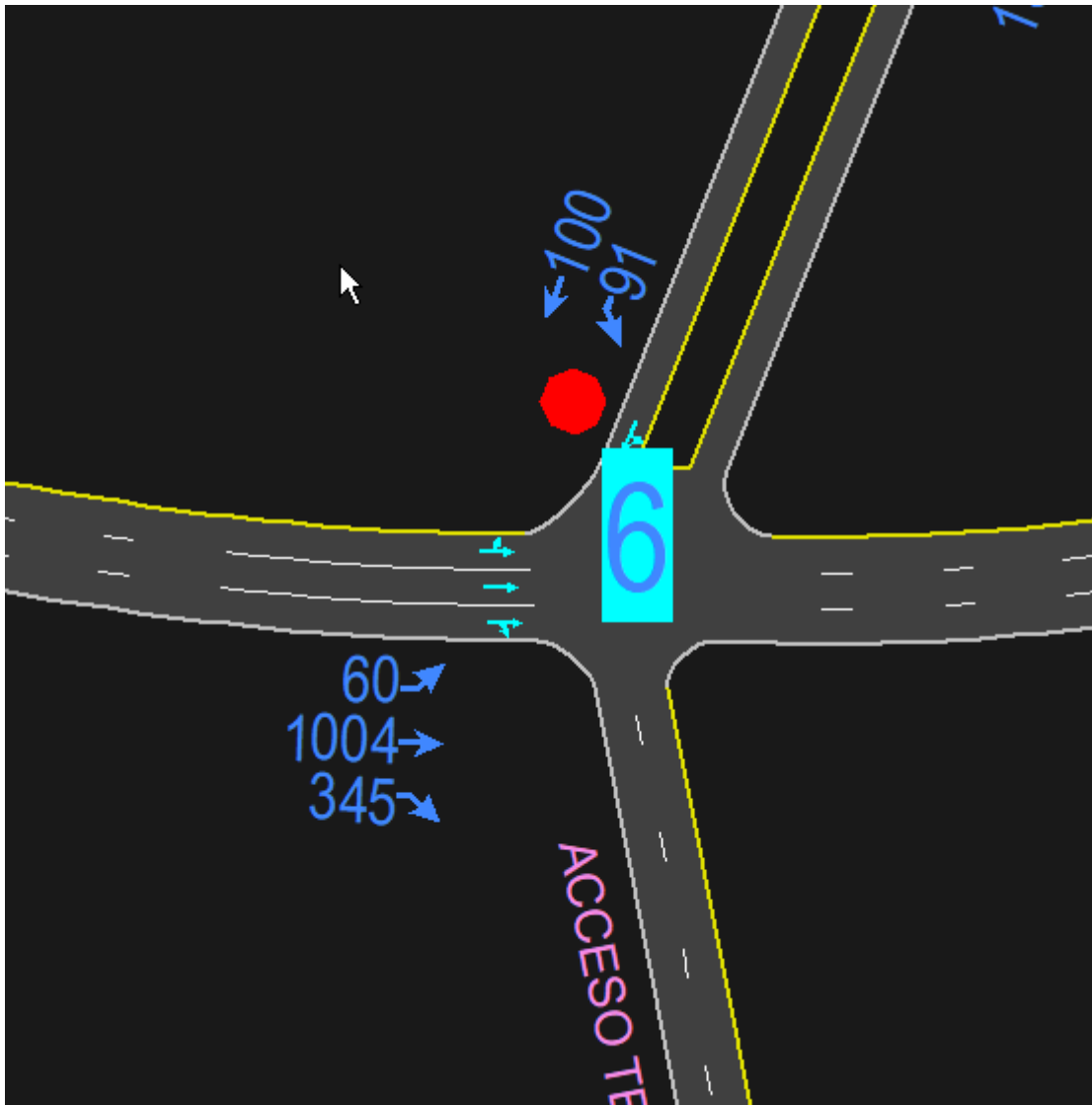

Figura 25. Nodo 8

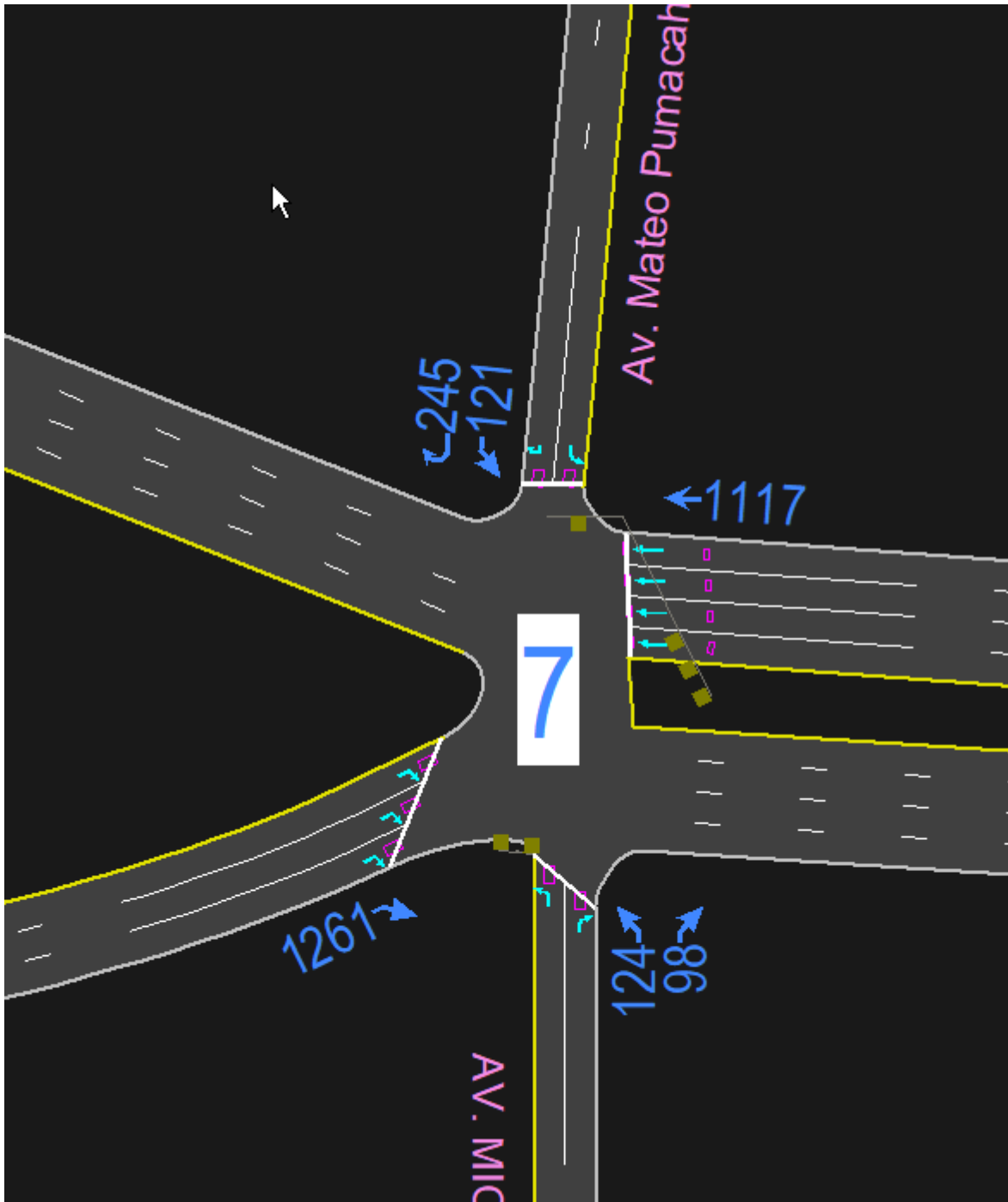

Figura 26. Nodo 9

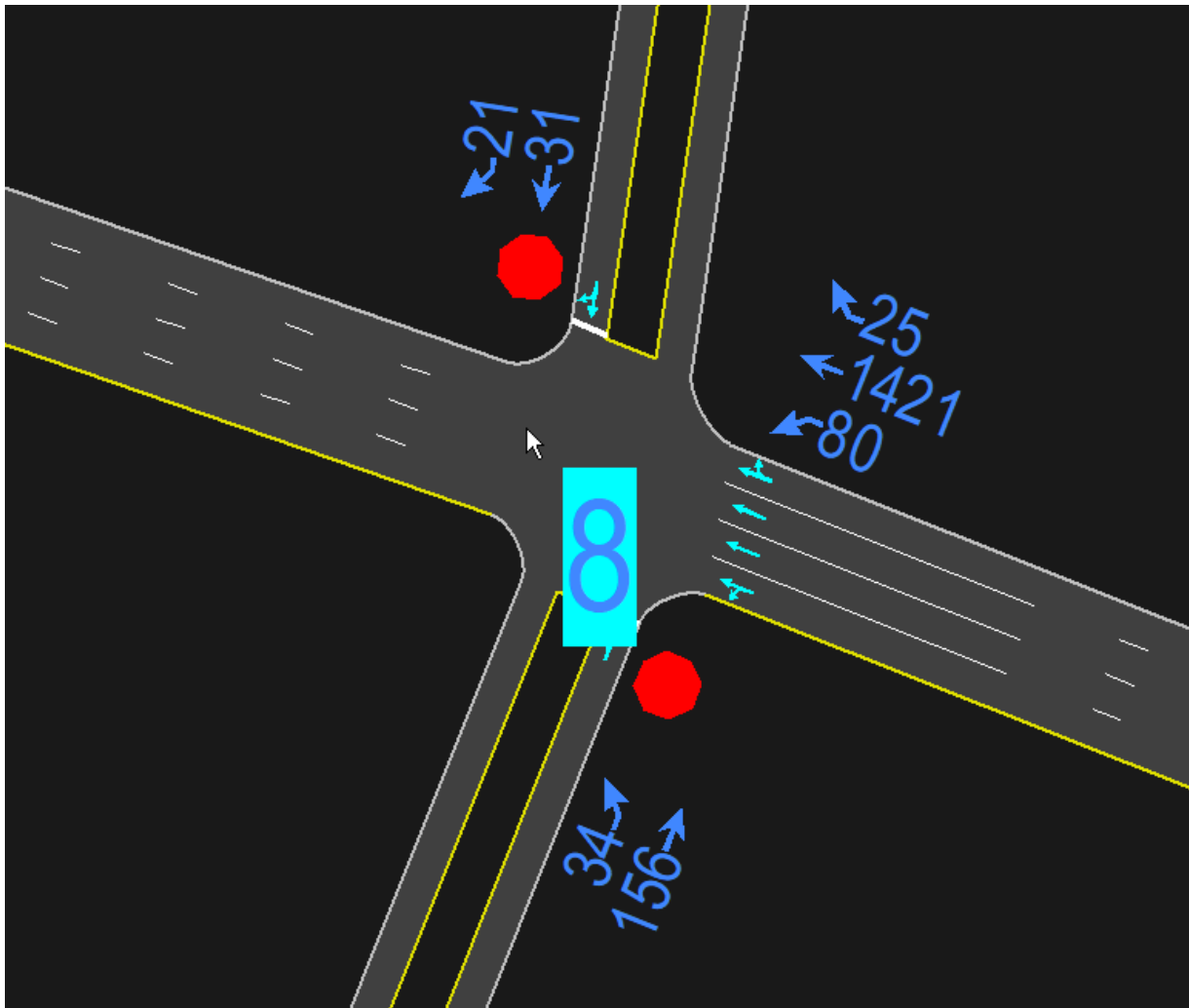

Figura 27. Nodo 10

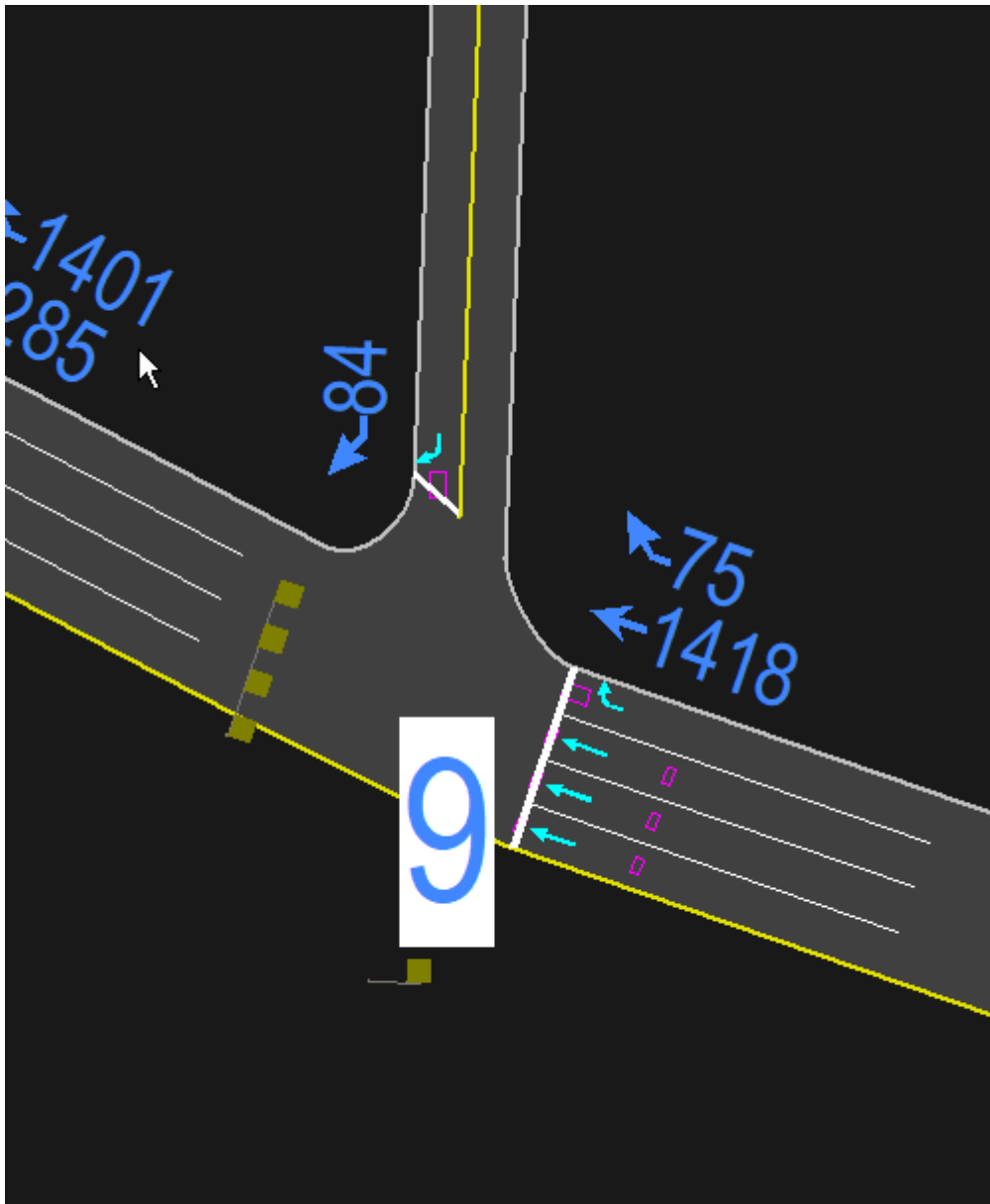

Figura 28. Nodo 11

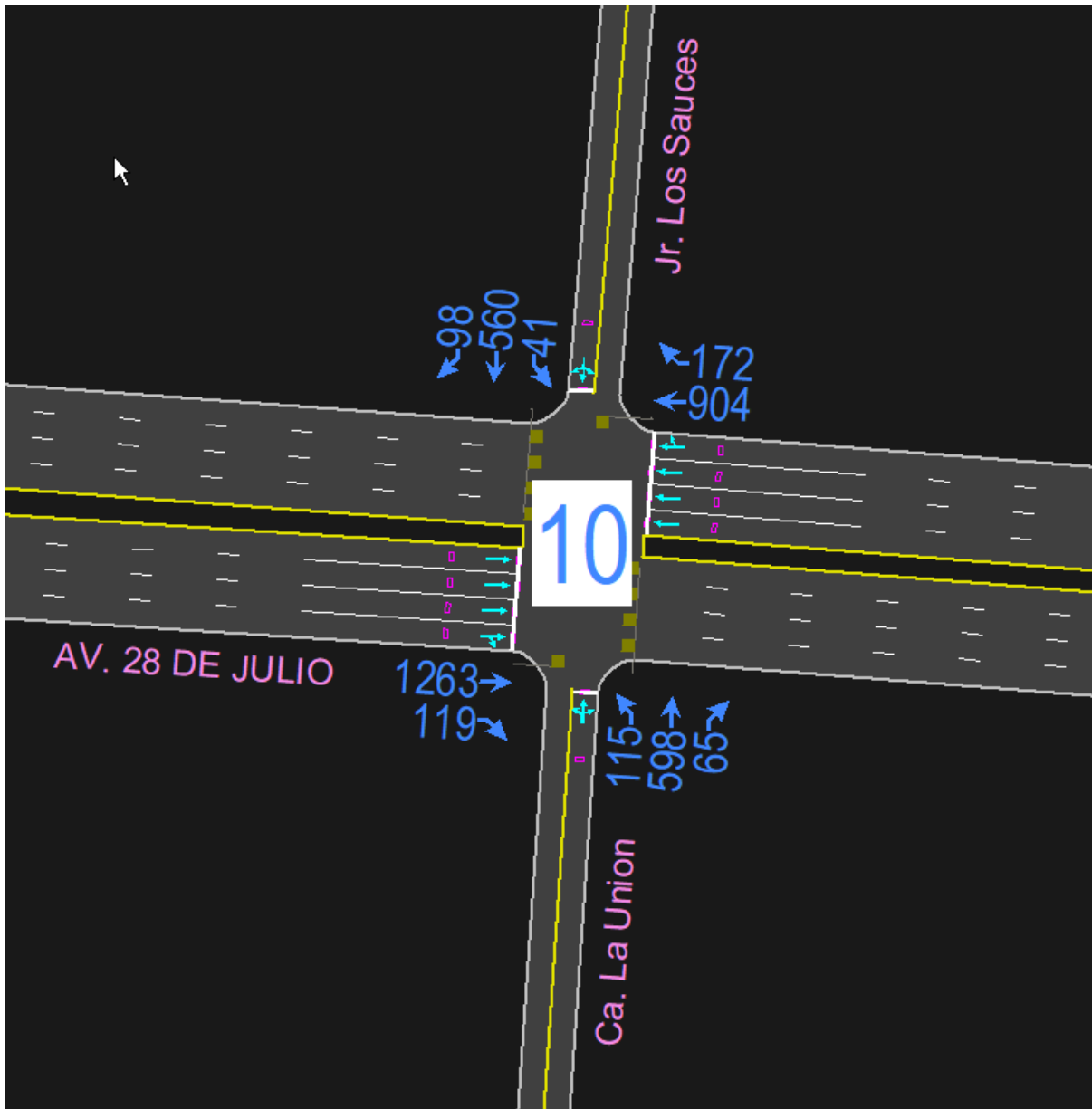

1.1.4. Tiempos semafóricos

Tabla 5. Tipo de semaforización, ciclo semafórico.

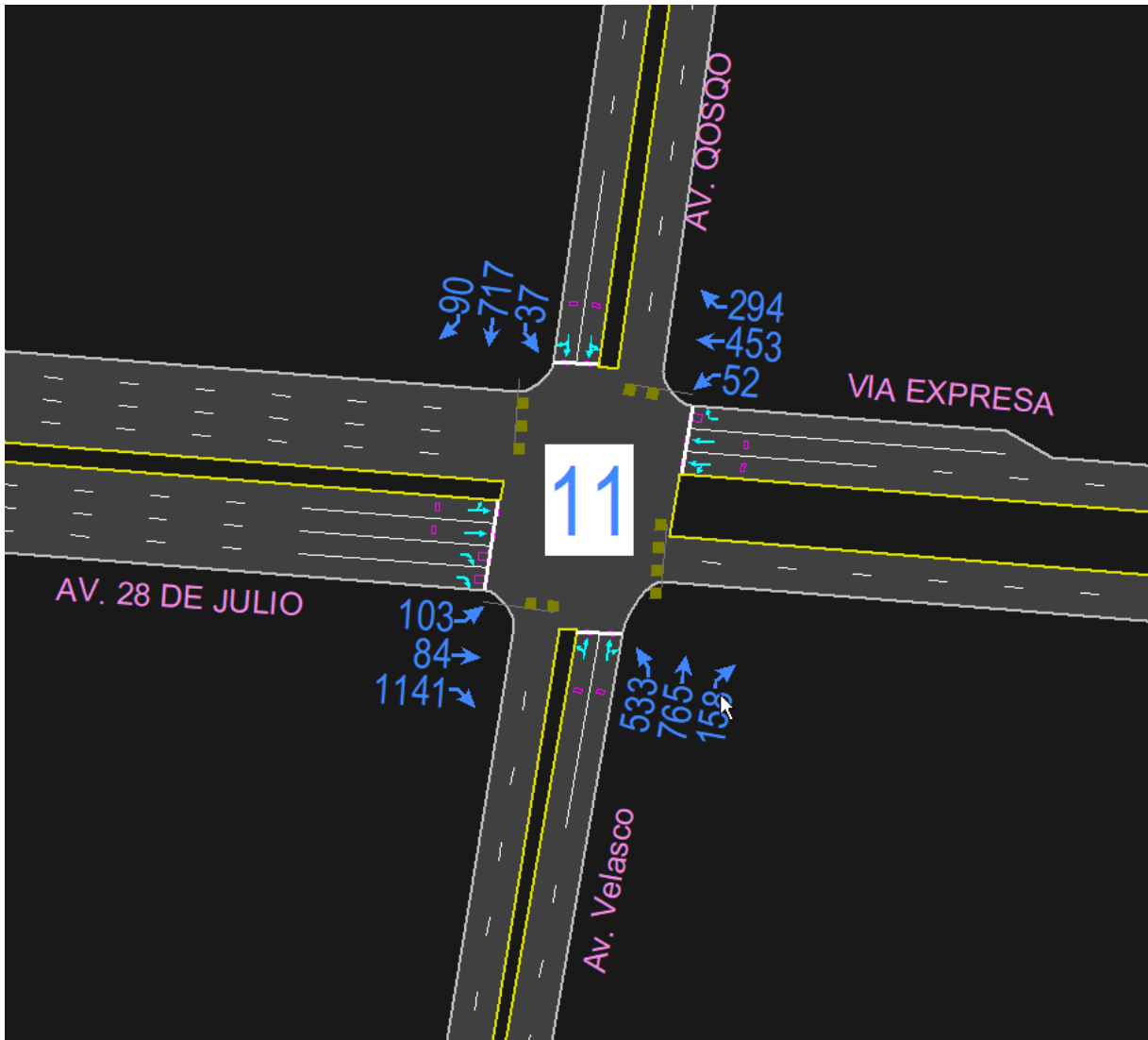
NODE SETTINGS	
Node #	1
Zone:	
X East (m):	-2368.8
Y North (m):	1277.6
Z Elevation (m):	0.0
Description	
Control Type	Pretimed
Cycle Length (s):	90.0
Lock Timings:	<input type="checkbox"/>
Optimize Cycle Length:	Optimize
Optimize Splits:	Optimize
Actuated Cycle(s):	90.0
Natural Cycle(s):	150.0
Max v/c Ratio:	1.49
Intersection Delay (s):	96.2
Intersection LOS:	F
ICU:	1.35
ICU LOS:	H
Offset (s) :	44.0
Referenced to:	Begin of Green
Reference Phase:	2+6 - NBTL SEL
Master Intersection:	<input type="checkbox"/>
Yield Point:	Single
Mandatory Stop On Yellow:	<input type="checkbox"/>

Tabla 6. Configuración de fases, tiempo de verde, split total, ámbar y rojo total.

TIMING SETTINGS														
	EBL2	EBL	EBR	NBL2	NBL	NBT	SBT	SBR	SBR2	SEL	SER	SER2	PED	HOLD
Lanes and Sharing (#RL)														
Traffic Volume (vph)	0	444	698	130	840	1399	0	212	756	76	1501	76		
Turn Type	—	—	Perm	Perm	Perm	—	—	—	Perm	—	Perm	Perm		
Protected Phases	—	4				2	4			6				
Permitted Phases	—		4	2	2				4		6	6		
Detector Phases	—	4	4	2	2	2	4		4	6	6	6		
Switch Phase	—	0	0	0	0	0	0		0	0	0	0		
Leading Detector (m)	—	2.0	2.0	2.0	—	10.0	10.0		2.0	2.0	2.0	2.0		
Trailing Detector (m)	—	0.0	0.0	0.0	—	0.0	0.0		0.0	0.0	0.0	0.0		
Minimum Initial (s)	—	4.0	4.0	4.0	4.0	4.0	4.0		4.0	4.0	4.0	4.0		
Minimum Split (s)	—	20.0	20.0	20.0	20.0	20.0	20.0		20.0	20.0	20.0	20.0		
Total Split (s)	—	32.0	32.0	58.0	58.0	58.0	32.0		32.0	58.0	58.0	58.0		
Yellow Time (s)	—	3.5	3.5	3.5	3.5	3.5	3.5		3.5	3.5	3.5	3.5		
All-Red Time (s)	—	0.5	0.5	0.5	0.5	0.5	0.5		0.5	0.5	0.5	0.5		
Lost Time Adjust (s)	—	0.0	0.0	0.0	—	0.0	0.0		0.0	0.0	0.0	0.0		



Intersection Summary	
Area Type:	Other
Cycle Length:	90
Actuated Cycle Length:	90
Offset:	44 (49%), Referenced to phase 2:NBTL and 6:SEL, Start of Green
Natural Cycle:	150
Control Type:	Pretimed
Maximum v/c Ratio:	1.49
Intersection Signal Delay:	96.2
Intersection LOS:	F
Intersection Capacity Utilization:	134.7%
ICU Level of Service:	H
Analysis Period (min)	15
~ Volume exceeds capacity, queue is theoretically infinite. Queue shown is maximum after two cycles.	
# 95th percentile volume exceeds capacity, queue may be longer. Queue shown is maximum after two cycles.	
m Volume for 95th percentile queue is metered by upstream signal.	
dr Defacto Right Lane. Recode with 1 though lane as a right lane.	
! Phase conflict between lane groups.	

Splits and Phases: 1: AV. SAN MARTIN & Av. Ejercito



Figura 29. Nodo 1 – Tiempos semafóricos y fases.

Intersection Summary	
Area Type:	Other
Cycle Length:	90
Actuated Cycle Length:	90
Offset:	56 (62%), Referenced to phase 2:NBT and 6:SBTL, Start of Green
Natural Cycle:	40
Control Type:	Pretimed
Maximum v/c Ratio:	4.31
Intersection Signal Delay:	399.2
Intersection LOS:	F
Intersection Capacity Utilization:	76.4%
ICU Level of Service:	D
Analysis Period (min)	15
~ Volume exceeds capacity, queue is theoretically infinite. Queue shown is maximum after two cycles.	
# 95th percentile volume exceeds capacity, queue may be longer. Queue shown is maximum after two cycles.	
m Volume for 95th percentile queue is metered by upstream signal.	

Splits and Phases: 2: AV. SAN MARTIN & Ca. Confraternidad



Figura 30. Nodo 2 – Tiempos semafóricos y fases.



Figura 31. Nodo 3 – Tiempos semafóricos y fases.



Figura 32. Nodo 7 – Tiempos semafóricos y fases.

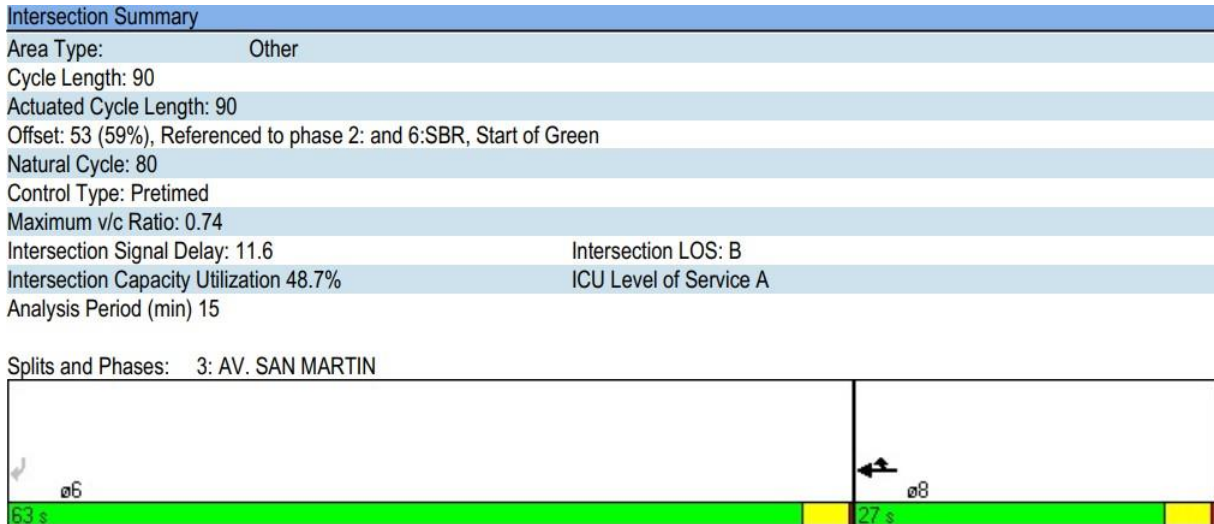

Figura 33. Nodo 9 – Tiempos semafóricos y fases.

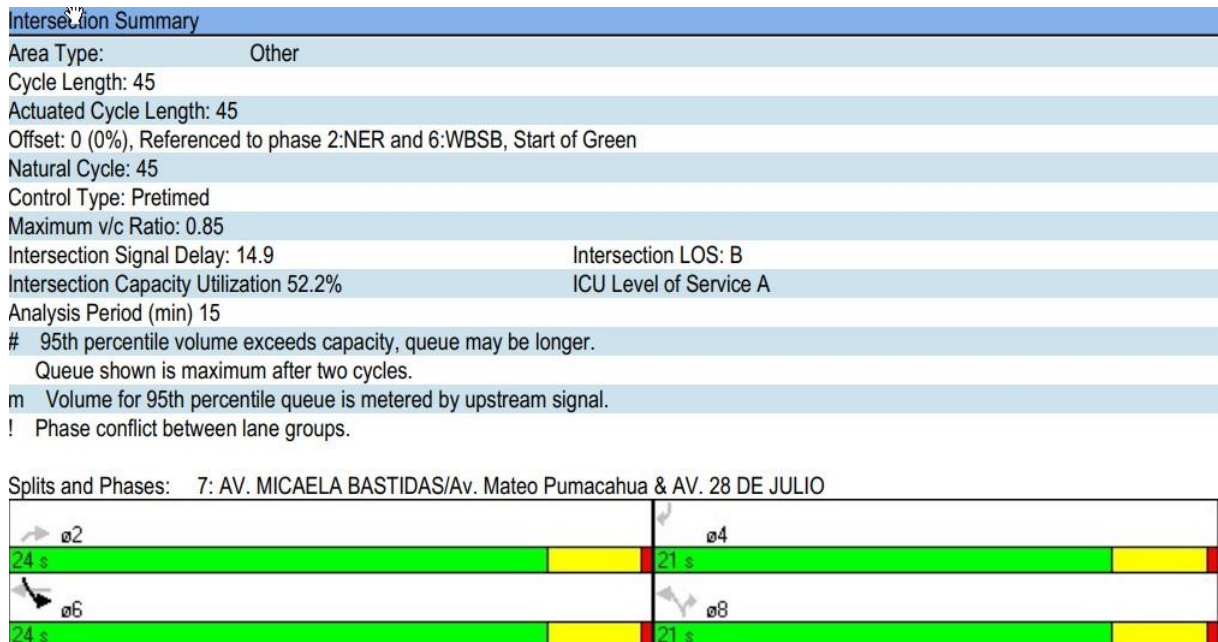

Figura 34. Nodo 10 – Tiempos semafóricos y fases.

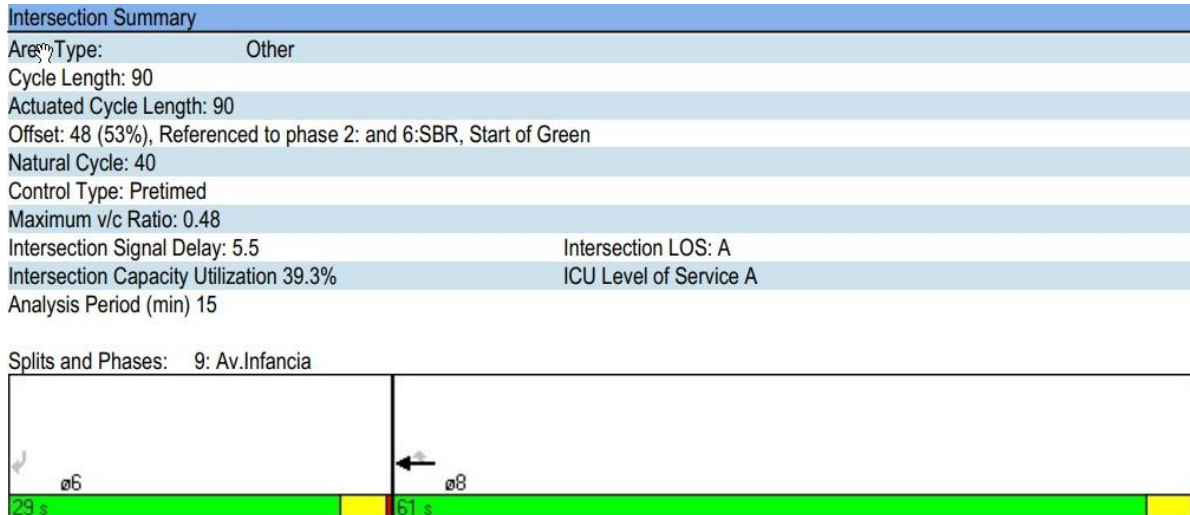

Intersection Summary

Area Type: Other
 Cycle Length: 40
 Actuated Cycle Length: 40
 Offset: 0 (0%), Referenced to phase 2:NBTL and 6:SBTL, Start of Green
 Natural Cycle: 120
 Control Type: Pretimed
 Maximum v/c Ratio: 1.87
 Intersection Signal Delay: 161.2 Intersection LOS: F
 Intersection Capacity Utilization 98.5% ICU Level of Service F
 Analysis Period (min) 15
 ~ Volume exceeds capacity, queue is theoretically infinite.
 Queue shown is maximum after two cycles.
 # 95th percentile volume exceeds capacity, queue may be longer.
 Queue shown is maximum after two cycles.
 dl Defacto Left Lane. Recode with 1 though lane as a left lane.

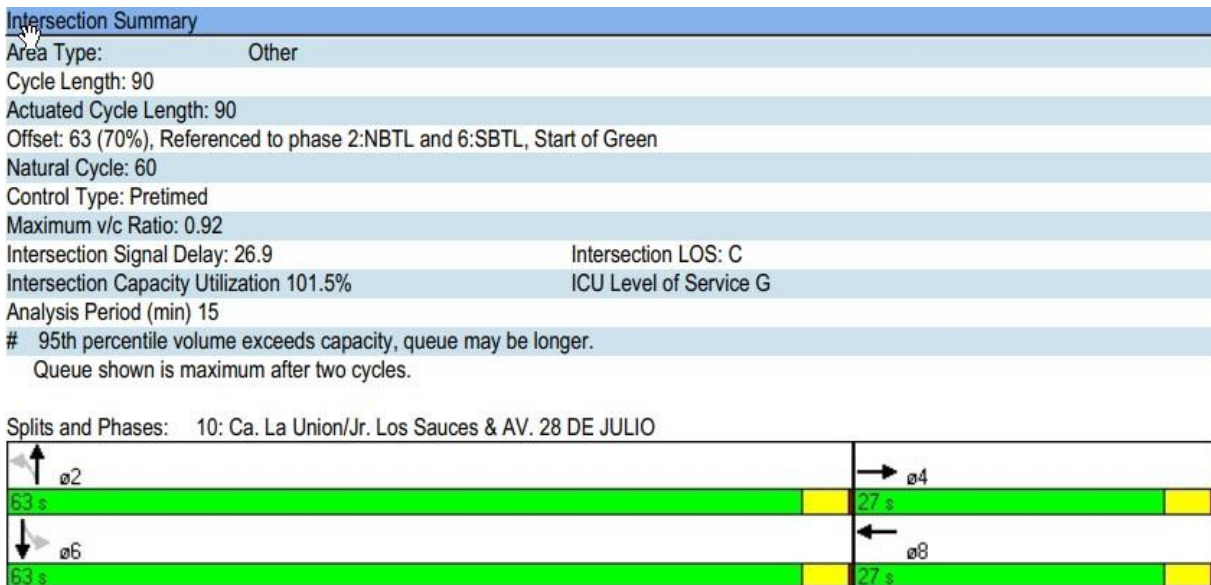
Splits and Phases: 11: Av. Velasco /AV. QOSQO & AV. 28 DE JULIO/VIA EXPRESA



Figura 35. Nodo 11 – Tiempos semafóricos y fases.



Capítulo IV: RESULTADOS

4.1. Resultado de la situación actual

NODO	DEMORAS	NDS	V/C
1	96.2	F	1.5
2	399	F	4.3
3	11.6	B	0.74
4	0.5	A	0.31
5	27.8	D	0.87
6	27.4	D	1.3
7	47.1	D	1.14
8	21.1	C	1.2
9	5.6	A	0.5
10	87.5	F	1.66
11	161	F	1.87

Se puede observar que las intersecciones 1, 2, 10 y 11, tienen niveles de servicio F, lo cual es superior al NDS aceptable (D) para zonas urbanas. El resto de intersecciones tiene niveles de servicio aceptables y no es necesario tomar acciones para mejorar la situación actual.

Como propuesta de solución se pueden testear las siguientes alternativas para las intersecciones que tienen niveles E y F:

- Desvío del tráfico, solo si es posible.
- Optimización de tiempos semafóricos
- Propuesta de paso a desnivel, en caso de que las soluciones anteriores no sean satisfactorias.
- Proyección del tráfico a 20 años, para la construcción de infraestructura de tipo Bypass. Simplificación del tráfico longitudinal.



Figura 36. Eliminar nodos de conflicto.

RESULTADOS DE LA PROPUESTA

NODO	DEMORAS	NDS	V/C
1	41.9	D	0.95
2	114	F	1.27
3	14.3	B	0.82
4	0.7	A	0.14
5	12	B	0.47
6	7	A	0.67
7	10.3	B	0.43
8	22	C	1.08
9	6.3	A	0.29
10	24.5	C	0.92
11	77	E	1.27



RESULTADOS COMPARATIVOS

NODO	%	%
	DEMORAS	V/C
1	-56%	-37%
2	-71%	-70%
3	23%	11%
4	40%	-55%
5	-57%	-46%
6	-74%	-48%
7	-78%	-62%
8	4%	-10%
9	13%	-42%
10	-72%	-45%
11	-52%	-32%

Para la mayoría de nodos se ha reducido las demoras y relación de saturación, lo cual demuestra que hay una mejora en la calidad de la circulación por efecto de colocar pasos a desnivel subterráneos o elevados.

El flujo vehicular para giros laterales e ingresos o cruces de las calles transversales se mantiene a nivel, mientras que los flujos longitudinales a lo largo de la Av. 28 de Julio y Av. San Martín a Ejército circularan a desnivel.

INCLUSION DE LA NUEVA OBRA VIA EXPRESA EN EL OVALO DE LIBERTADORES.

Para el cual el ovalo a nivel tiene los flujos laterales



SITUACIÓN ACTUAL DE LA CONSTRUCCIÓN DE LA VIA EXPRESA EN EL ÓVALO LIBERTADORES

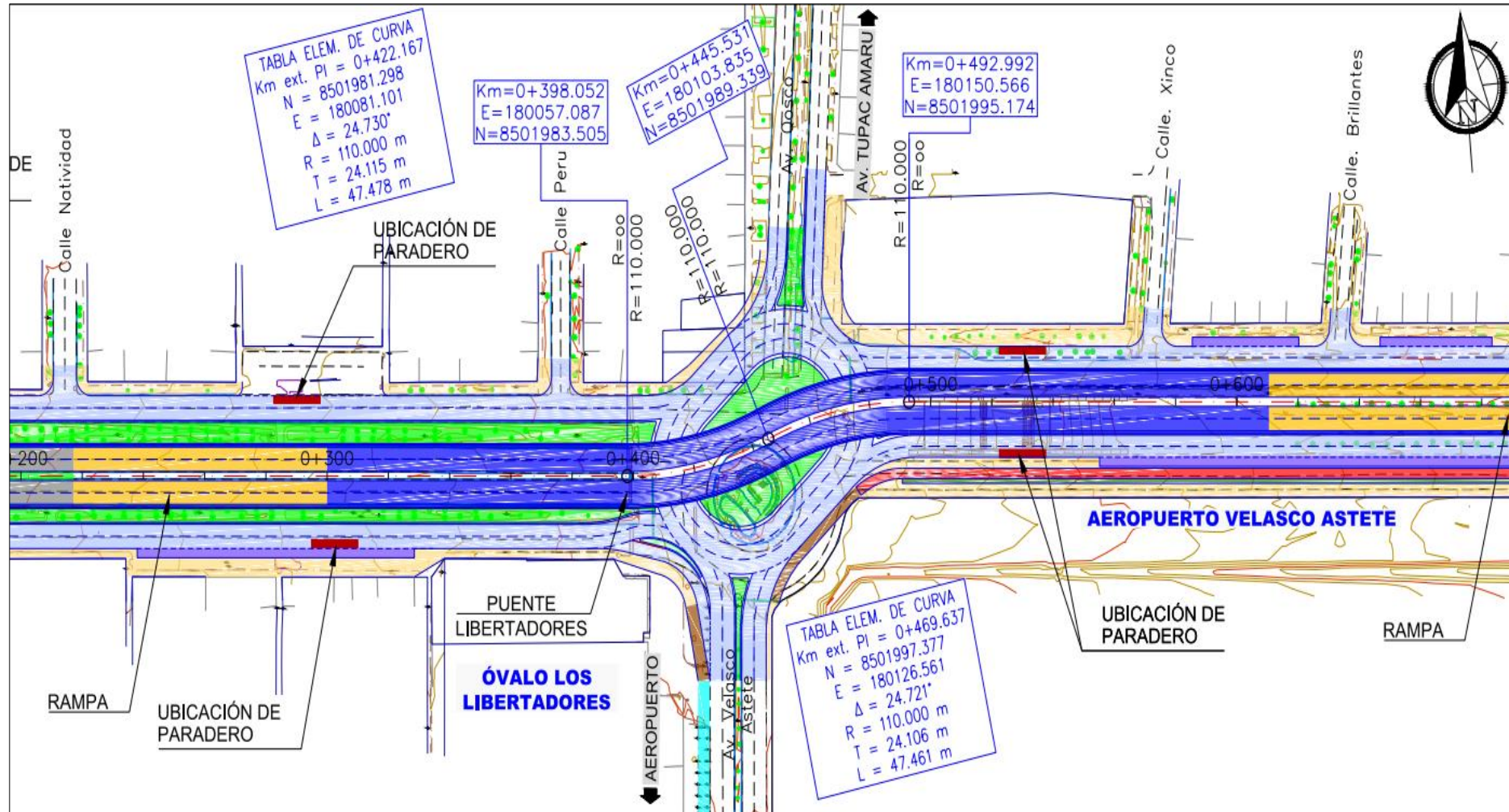



ESQUEMA DE LA SOLUCION PLANTEADA CON BY PASS EN LOS OVALOS E INTERSECCIONES.

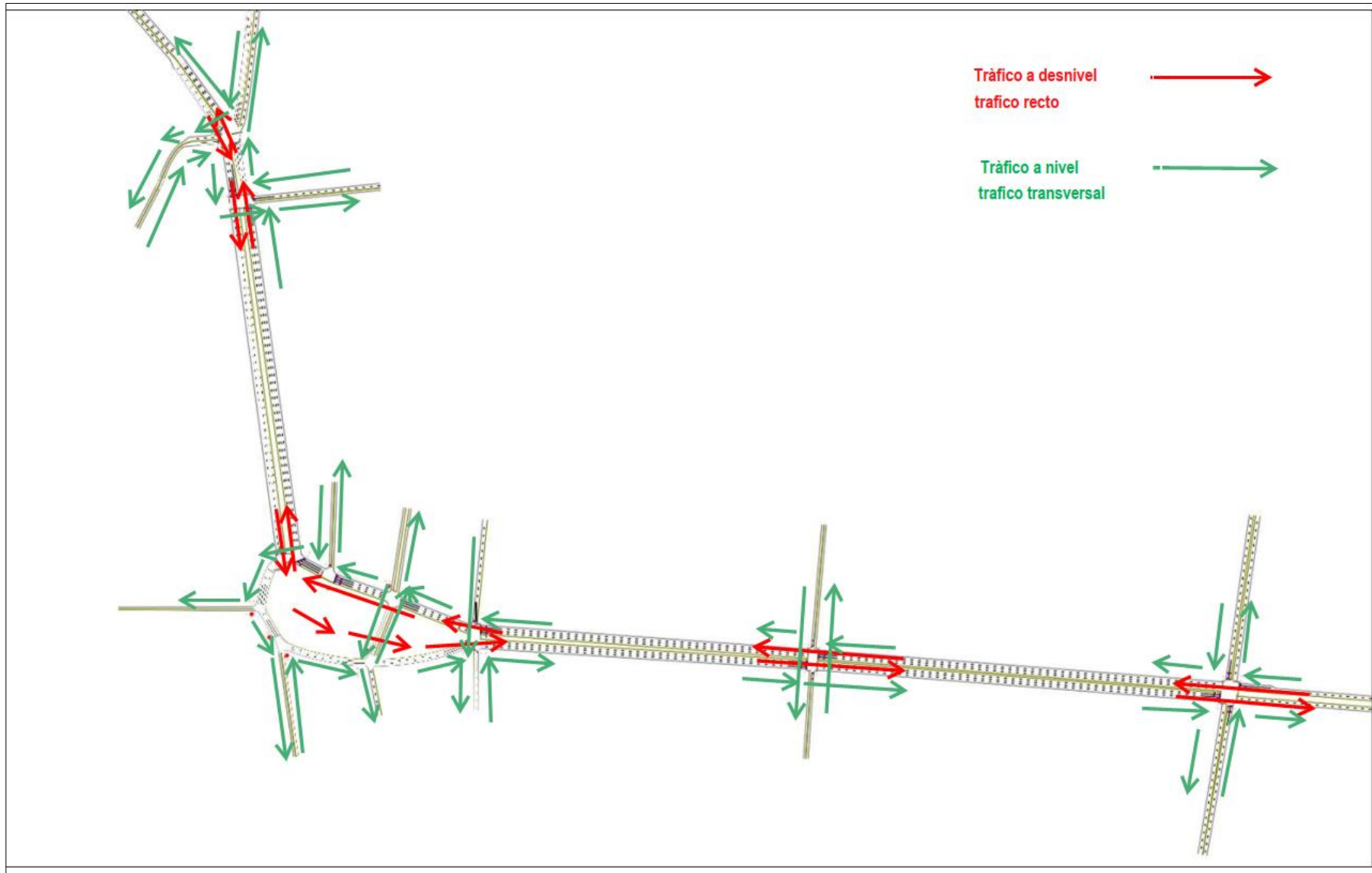



ESQUEMA DE LA SOLUCION PLANTEADA CON BY PASS EN LOS OVALOS E INTERSECCIONES.

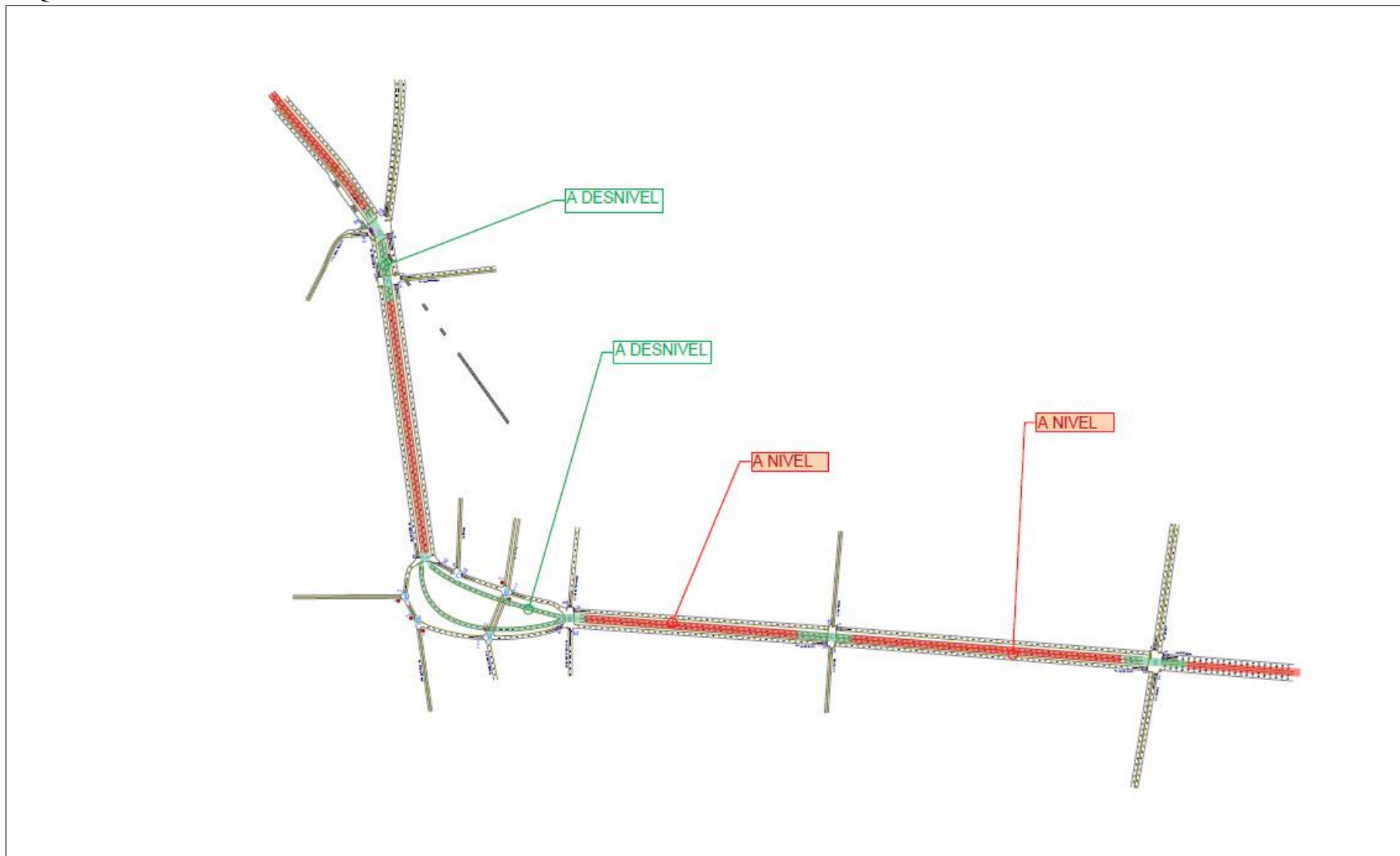



GLOSARIO

A

Acceso

Carril o grupo de carriles por el cual transita un flujo vehicular que colinda con otros accesos generando una intersección.

Accidente de tránsito

Cualquier hecho fortuito u ocurrencia entre uno o más vehículos en una vía pública o privada.

Accidentalidad

Circunstancias que favorecen la ocurrencia de accidentes.

Ahuellamiento

Surcos o huellas que se presentan en la superficie de rodadura de una carretera pavimentada o no pavimentada y que son el resultado de la consolidación o movimiento lateral de los materiales por efectos del tránsito.

Arteria

Calle destinada primordialmente a facilitar el tránsito de paso. Su fin secundario es el acceso a las propiedades colindantes. Suele estar dominada por semáforos.

B

Bache

Hueco que se hace en la capa de rodadura de una vía, por la acción del tránsito, el agua y otros agentes destructores.



C

Calle de doble sentido

Calle donde el tránsito circula en ambos sentidos.

Calle de sentido único

Vía urbana donde sólo se permite la circulación del tránsito en un sentido.

Calzada

Parte de la carretera destinada a la circulación de Vehículos. Se compone de un cierto número de carriles

Carril

Parte de la calzada destinada a la circulación de una fila de vehículos en un mismo sentido de tránsito.

Ciclo o Longitud de ciclo

Tiempo necesario para una secuencia completa de todas las indicaciones del semáforo

Conductor

Aquel sujeto que maneja el mecanismo de dirección o va al mando de un vehículo.

D

Derecho de vía

Faja de terreno de ancho variable dentro del cual se encuentra comprendida la carretera, sus obras complementarias, servicios, áreas previstas para futuras obras de ensanche o



mejoramiento, y zonas de seguridad para el usuario. Su ancho se establece mediante resolución del titular de la autoridad competente respectiva.

Dispositivos de control de tránsito

Señales, marcas, semáforos y dispositivos auxiliares que tienen la función de facilitar al conductor la observancia estricta de las reglas que gobiernan la circulación vehicular, tanto en carreteras como en las calles de la ciudad.

Distancia de adelantamiento

Distancia necesaria para que, en condiciones de seguridad, un vehículo pueda adelantar a otro que circula a menor velocidad, en presencia de un tercero que circula en sentido opuesto. En el caso más general es la suma de las distancias recorridas durante la maniobra de adelantamiento propiamente dicha, la maniobra de reincorporación a su carril delante del vehículo adelantado, y la distancia recorrida por el vehículo que circula en sentido opuesto.

E

Estacionamiento

Lugar donde se proporciona espacio para estacionar fuera de la vía pública.

I

Infraestructura vial

Es todo el conjunto de elementos que permite el desplazamiento de vehículos en forma confortable, segura y eficiente desde un punto a otro en un sistema vial.

Intersecciones viales

Las intersecciones son áreas comunes a dos o más vías que se cruzan al mismo nivel o a desnivel.



P

Pendiente

Inclinación de una rasante en el sentido de avance.

R

Ramal

Es un acceso a la intersección.

S

Seguridad vial

Conjunto de acciones orientadas a prevenir o evitar los riesgos de accidentes de los usuarios de las vías y reducir los impactos sociales negativos por causa de la accidentalidad.

Semáforos

Los semáforos son los elementos reguladores del tráfico por excelencia en las zonas urbanas.

Señalización horizontal

Conjunto de rayas, marcas, símbolos y letras que se hacen con pintura o un material similar sobre el pavimento con el fin de regular el tránsito vehicular y de peatones.

Señalización vertical

Es el conjunto de tableros de señalización vial fijados a postes, estructuras o construcciones, con símbolos o “leyendas” y que se instalan en la vía pública para regular el tránsito de vehículos y peatones. En cuanto a su función, la señalización vertical generalmente se clasifica en tres tipos: informativas, preventivas y reglamentarias.



T

Transito

Fenómeno ocasionado por la presencia de vehículos, personas y demás que circulan por una avenida, calle o autopista.

V

Vehículo

Es el nexo entre el conductor que lo maneja y la vía que lo contiene

Velocidad

Se define como la relación entre el espacio recorrido y el tiempo que se tarda en recorrerlo.

Volumen de tránsito

Volumen de Vehículos y peatones que transitan por una vía



DISCUSIONES

Discusión 1:

¿Es posible utilizar la microsimulación para obtener resultados de niveles de servicio y demoras en intersecciones?

Si, ya que la herramienta de microsimulación nos permite incluir características geométricas, demanda vehicular, demanda peatonal, sistema de control como semaforización con diferente fases y tiempos, así como cualquier tipo de señalización de prioridad para el uso de una intersección.

Discusión 2:

¿Es posible modificar la infraestructura vial de las intersecciones en el Cusco?

Si, mientras se cumplan las condiciones necesarias y geometría disponible para realizar pasos a desnivel. En esta zona esta fuera de la zona de centro histórico porque lo sí sería factible realizar excavaciones masivas.

Discusión 3:

¿La metodología del Manual de capacidad es parte del cálculo de las demoras y niveles de servicio cuando se usa un software de simulación?

Parcialmente, al realizar la micro simulación de las intersecciones, la metodología DETERMINISTICA considera un entorno de realidad virtual basados en formulas del manual en la cual los autos y peatones interactúan bajo los sistemas de control que son los semáforos. Producto de esta, el software calculo la demora que experimenta cada vehículo usando el tiempo y la trayectoria para cruzar la intersección. Luego de calcular el tiempo de demora promedio de todos los vehículos bajo dos diferentes entornos, usa las tablas del manual HCM para la estimación del nivel de servicio que corresponde a cada calle.

Discusión 4:

¿Cuál es la diferencia entre la micro simulación y el método del HCM?

Si bien ambos métodos llegan a calcular las demoras, esto lo hacen de manera diferente. El método del HCM es determinístico y exacto, dado que se basa en la aplicación de fórmulas teóricas para el cálculo de demoras, basado en parámetros de circulación como geometría, demanda y control. Por otro lado, el método de creación de un entorno virtual de micro simulación, crea un entorno de restricciones para la circulación e interacción entre peatones y vehículos, generando así limitaciones en la circulación, computando el tiempo inicial de un auto al entrar a la intersección y otro de salida para el cálculo de lo que duraría un auto en pasar la intersección.

Discusión 5:

¿Cómo se da validez a la modelación al realizar el micro simulación?

Cuando la toma de datos de campo se refleja en el modelo, y se obtienen resultados parecidos y muy similares a los volúmenes aforados, se dice que el modelo es válido por que representa un modelo de realidad virtual base, a partir del cual se puede usar a un modelo de propuesta.



CONCLUSIONES

CONCLUSIÓN N° 1:

HG: *“La congestión y nivel de servicio de las intersecciones del sistema vial entre los óvalos Chambi, Pachacútec y Libertadores no son adecuadas de acuerdo a parámetros de calidad del servicio”.*

Se cumple parcialmente, como se han visto en el capítulo IV, 04 intersecciones principales tienen valores no aceptables (E y F), donde se ha superado la capacidad vial y experimentan congestión.

CONCLUSIÓN N°2:

HE 1: *“Las condiciones de tráfico influyen en la capacidad vial de las intersecciones que están entre los óvalos Martín Chambi, Pachacutec y Libertadores.”*

Se cumple, la cantidad de vehículos en cada acceso o calle, porcentaje de vehículos pesados y presencia de peatones, son parte del Cálculo de las demoras vehiculares y por lo tanto son parte de la determinación de los niveles de servicio.

CONCLUSIÓN N°3:

HE 2: *“Las condiciones geométricas influyen en la capacidad vial de las intersecciones semaforizadas y no semaforizadas entre los óvalos Martín Chambi, Pachacútec y Libertadores.”*

Se cumple, ya que, al determinar la cantidad de carriles y el ancho de los mismos, así como las pendientes longitudinales, son parte del Cálculo de las demoras vehiculares y por lo tanto han servido para la determinación de los niveles de servicio.

CONCLUSIÓN N°4:

HE 3: *“El estado de las condiciones semafóricas influyen en la capacidad vial de las intersecciones semaforizadas y no semaforizadas de los óvalos Martín Chambi, Pachacútec y Libertadores.”*

Se cumple, ya que, al determinar las fases, ciclo semafórico, tiempos de verde, ámbar y rojo total, son parte del cálculo de la capacidad y de las demoras vehiculares y por lo tanto han servido para la determinación de los niveles de servicio.



CONCLUSIÓN N°5:

HE 4: *“La diferencia de los tiempos de demora que influyen en el nivel de servicio semaforizadas y no semaforizadas de los óvalos Martin Chambi, Pachacútec y Libertadores es significativa.”*

Se cumple, ya que al realizar mejoras como optimización semafórica y simplificación del flujo vehicular por medio de la inclusión de bypasses en los nodos de conflicto con niveles de servicio F, se han podido lograr mejoras significativas.

CONCLUSIÓN N°6:

HE 5: *“Las intersecciones semaforizadas y no semaforizadas entre los óvalos Martin Chambi, Pachacútec y Libertadores tiene una relación de saturación mayor a 0.8.”*

Se cumple, tal como se muestran en la tabla de resultados para el diagnóstico o situación actual. Las intersecciones 3,4 y 9 son las únicas que no cumplen esta condición, el resto de las 11 intersecciones si sobrepasan valores de 0.8



5 Recomendaciones

5.1. RECOMENDACIÓN N°1

Se recomienda, evaluar en próximas investigaciones la restricción de tráfico como alternativa para la reducción de la demanda vehicular. Basado en el control de taxis piratas que circulan en estas arterias.

5.2. RECOMENDACIÓN N°2

Se recomienda usar valores ajustados del flujo de saturación vehicular para el cálculo de las demoras, usando valores locales de las arterias en análisis.

5.3. RECOMENDACIÓN N°3

Se recomienda introducir en el cálculo la presencia de peatones en conflicto para el cálculo de demoras y niveles de servicio, así como la capacidad vehicular de cada movimiento o grupo de movimientos vehiculares determinados.

5.4. RECOMENDACIÓN N°4

Se recomienda realizar un cálculo de demoras usando el método del seguimiento vehicular y micro simulación para representar más exactamente la geometría de los óvalos presentes en la investigación.

5.5. RECOMENDACIÓN N°5

Se recomienda análisis, los horarios PM y Medio Día para evaluar la variación del tráfico y calcular los niveles de servicio.



6 Referencias

- Consejo Nacional de Seguridad Vial . (2008). *GUÍA DE EDUCACIÓN EN SEGURIDAD VIAL*. Lima: JB Grafic EIRL. Jr. Las Anemonas 772, Lima 36.
- Dourthé Castrillón, A., & Salamanca Candia, J. (2003). Consideraciones generales de Seguridad Vial. *Guía para realizar una Auditoría de Seguridad Vial*, 21-34.
- aprimerahora.pe. (23 de julio de 2019). *Dos vehículos chocan y dejan 5 heridos graves en Vía Evitamiento*. Obtenido de aprimerahora.pe: <https://aprimerahora.pe/2019/07/23/dos-vehiculos-chocan-y-dejan-5-heridos-graves-en-via-evitamiento/>
- Austroroads. (2015). *Guide to Traffic Management Part 2: Traffic Theory*. Australia: Sydney.
- Bañon Blazques, L., & Bevia Garcia, J. (2000). *Manual de carreteras, Elementos y Proyectos*. Alicante, España: : Ortiz e Hijos, Contratista de Obras.
- Bernal, C. (2010). *Metodología de la Investigación administración, economía, humanidades y ciencias sociales Tercera edición*. Colombia: PEARSON EDUCACIÓN.
- Cal, R., & Mayor, R. (2007). *Ingeniería de Tránsito Fundamentos y Aplicaciones 8va Edición*. México: Alfaomega Grupo Editor S.A. de C.V.
- Chavez, L. (2005). *Manual de Diseño Geométrico de Vías Urbanas*. Lima.
- CONASET. (2003). *Guía para Realizar una Auditoría de Seguridad Vial*. Santiago - Chile, Chile: Corporación Nacional del Cobre de Chile CODELCO, División El Teniente.
- CONASET. (2005). *Aplicación de medidas correctivas de bajo costo*. Santiago de Chile, Chile.
- COPV. (2010). *Manual de Inspección de Seguridad Vial de la Red Autonómica de Carreteras de Andalucía*. Andalucía, España: Publidisa.
- Dextre, J. (2008). Señalización vial: De la teoría a la práctica. *Primer Congreso Iberoamericano de Seguridad Vial*.
- Dextre, J. C., Ríos, F., Aranda, F., & Manchego, X. (17 de Octubre de 2018). *VI Congreso Iberoamericano de Seguridad Vial*. Obtenido de https://vicisev.institutoivia.org/wp-content/uploads/2018/11/dextre-inspecciones-ISV-Cluster-Tingo-Mar%C3%ADa_cisev18-V4-final.pdf



PANEL FOTOGRAFICO

INTERSECCION AV. EJERCITO Y AV. SAN MARTIN:



Fuente: Elaboración Propia



Fuente: Elaboración Propia



Fuente: Elaboración Propia



Fuente: Elaboración Propia



INTERSECCION OVALO PACHACUTEC Y AV. SAN MARTIN:



Fuente: Elaboración Propia



Fuente: Elaboración Propia



Fuente: Elaboración Propia



Fuente: Elaboración Propia



INTERSECCION OVALO PACHACUTEC Y AV. INFANCIA:



Fuente: Elaboración Propia



Fuente: Elaboración Propia



Fuente: Elaboración Propia



Fuente: Elaboración Propia



INTERSECCION OVALO PACHACUTEC Y AV MATEO PUMACACHUA:



Fuente: Elaboración Propia



Fuente: Elaboración Propia



Fuente: Elaboración Propia



Fuente: Elaboración Propia



INTERSECCION OVALO PACHACUTEC Y AV. 28 DE JULIO:



Fuente: Elaboración Propia



Fuente: Elaboración Propia



Fuente: Elaboración Propia



Fuente: Elaboración Propia



INTERSECCION OVALO PACHACUTEC Y AV. 28 DE JULIO:



Fuente: Elaboración Propia



Fuente: Elaboración Propia



Fuente: Elaboración Propia



Fuente: Elaboración Propia



INTERSECCION OVALO PACHACUTEC Y AV. MICAELA BASTIDAS:



Fuente: Elaboración Propia



Fuente: Elaboración Propia



Fuente: Elaboración Propia



Fuente: Elaboración Propia



INTERSECCION OVALO PACHACUTEC Y AV. 28 DE JULIO:



Fuente: Elaboración Propia



Fuente: Elaboración Propia



Fuente: Elaboración Propia



Fuente: Elaboración Propia



**INTERSECCION OVALO PACHACUTEC – ACCESO AL TERMINAL Y AV.
VALLEJOS SANTONI:**



Fuente: Elaboración Propia



Fuente: Elaboración Propia



Fuente: Elaboración Propia



Fuente: Elaboración Propia



INTERSECCION AV. CONFRATERNIDAD Y AV. SAN MARTIN:



Fuente: Elaboración Propia



Fuente: Elaboración Propia



Fuente: Elaboración Propia



Fuente: Elaboración Propia



AV. SAN MARTIN CARRIL DE SUBIDA PRIMER SEMAFORO:



Fuente: Elaboración Propia



Fuente: Elaboración Propia



Fuente: Elaboración Propia



Fuente: Elaboración Propia



INTERSECCION AV. SAN MARTIN Y AV. CONFRATERNIDAD:

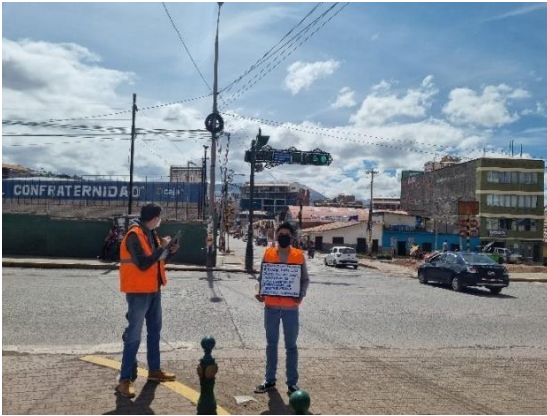

Fuente: Elaboración Propia



Fuente: Elaboración Propia



Fuente: Elaboración Propia



Fuente: Elaboración Propia



AV. SAN MARTIN CARRIL DE SUBIDA 2DO SEMAFORO:



Fuente: Elaboración Propia



Fuente: Elaboración Propia



Fuente: Elaboración Propia



Fuente: Elaboración Propia



INTERSECCION ALAMEDA PACHACUTEO Y AV. SAN MARTIN:



Fuente: Elaboración Propia



Fuente: Elaboración Propia



Fuente: Elaboración Propia



Fuente: Elaboración Propia



INTERSECCION AV. EJERCITO Y AV. SAN MARTIN:



Fuente: Elaboración Propia



Fuente: Elaboración Propia



Fuente: Elaboración Propia



Fuente: Elaboración Propia



INTERSECCION AV. AGUSTIN GAMARRA Y AV. SAN MARTIN:



Fuente: Elaboración Propia



Fuente: Elaboración Propia



Fuente: Elaboración Propia



Fuente: Elaboración Propia



INTERSECCION AV. 28 DE JULIO Y CA. LA UNION:



Fuente: Elaboración Propia



Fuente: Elaboración Propia

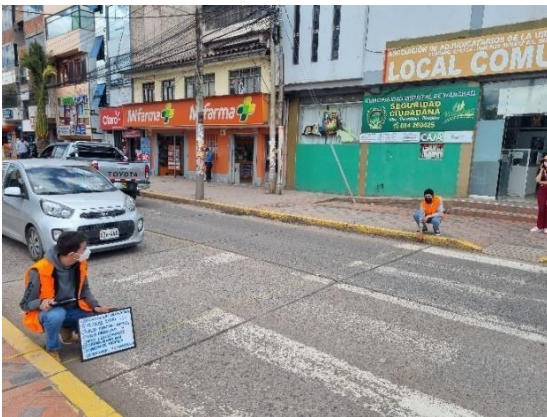

Fuente: Elaboración Propia



Fuente: Elaboración Propia



INTERSECCION AV. 28 DE JULIO Y CA. LA UNION:



Fuente: Elaboración Propia



Fuente: Elaboración Propia



Fuente: Elaboración Propia



Fuente: Elaboración Propia



INTERSECCION AV. 28 DE JULIO Y JR. LOS SAUCES:



Fuente: Elaboración Propia



Fuente: Elaboración Propia



Fuente: Elaboración Propia



Fuente: Elaboración Propia



INTERSECCION AV. 28 DE JULIO Y JR. LOS SAUCES:



Fuente: Elaboración Propia



Fuente: Elaboración Propia

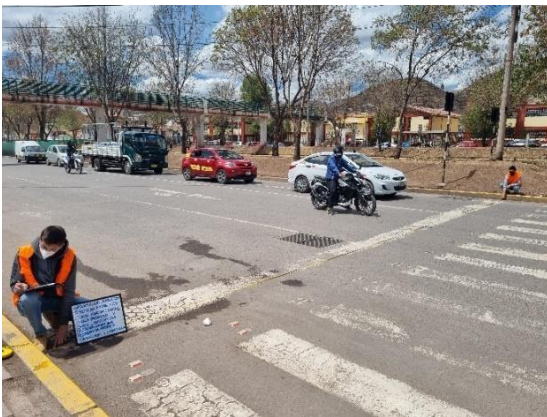

Fuente: Elaboración Propia



Fuente: Elaboración Propia



INTERSECCION AV. 28 DE JULIO AV.OOSOO / VIA EXPRESA:



Fuente: Elaboración Propia



Fuente: Elaboración Propia



Fuente: Elaboración Propia



Fuente: Elaboración Propia



INTERSECCION AV. 28 DE JULIO AV.OOSOO / VIA EXPRESA:



Fuente: Elaboración Propia



Fuente: Elaboración Propia



Fuente: Elaboración Propia



Fuente: Elaboración Propia



INTERSECCION AV. 28 DE JULIO AV.OOSOO / VIA EXPRESA:



Fuente: Elaboración Propia



Fuente: Elaboración Propia



Fuente: Elaboración Propia



Fuente: Elaboración Propia

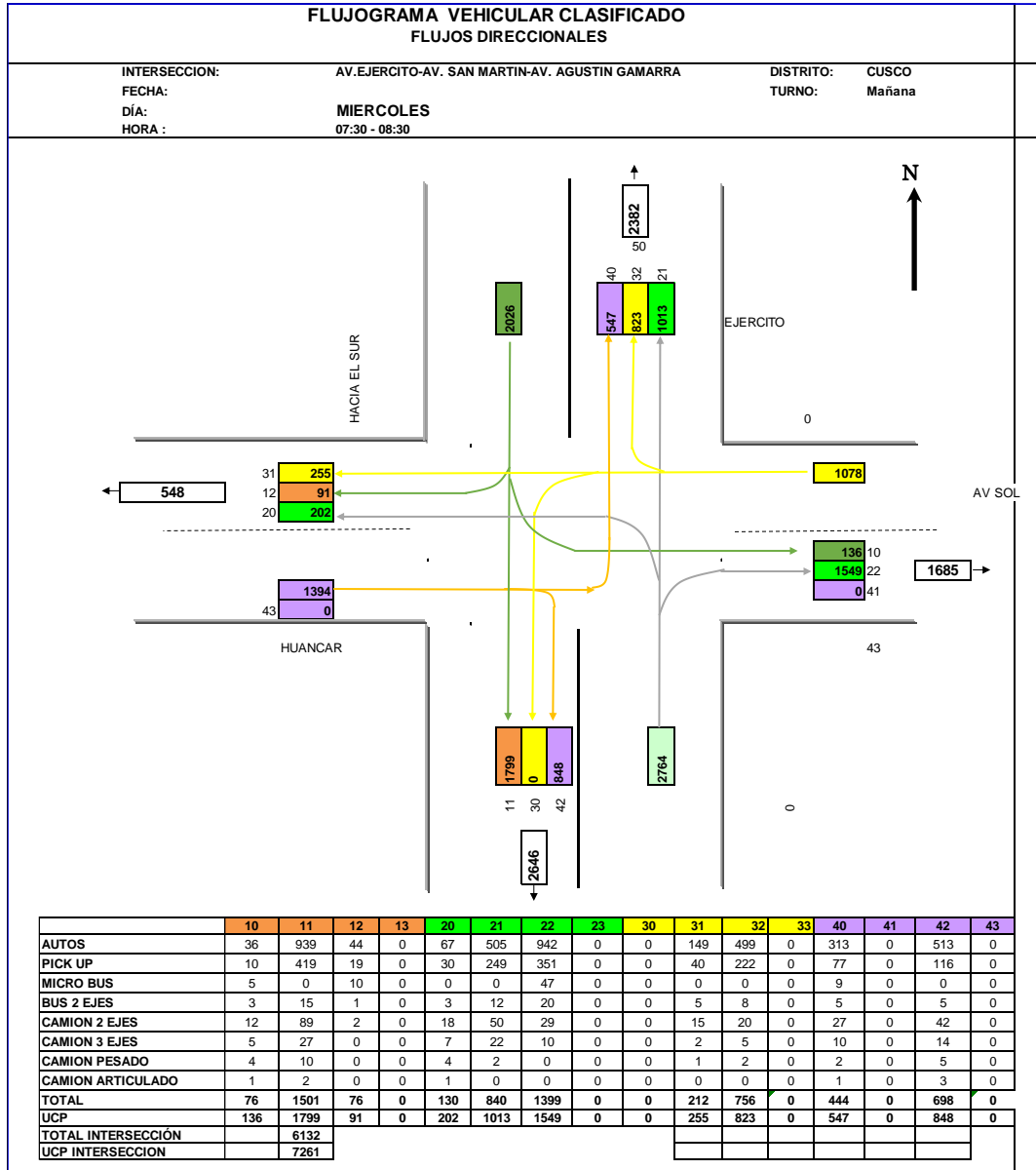

	10	11	12	13	20	21	22	23	30	31	32	33	40	41	42	43
Autos	46	1358	63	0	97	754	1293	0	0	189	721	0	390	0	629	0
T.U	8	15	11	0	3	12	67	0	0	5	8	0	14	0	5	0
Camion		128	2	0	30	74	39	0	0	18	27	0	40	0	64	0
Mototaxi																
TOTAL	54	1501	76	0	130	840	1399	0	0	212	756	0	444	0	698	0
%	1%	25%	1%	0%	2%	14%	23%	0%	0%	3%	12%	0%	7%	0%	11%	0%

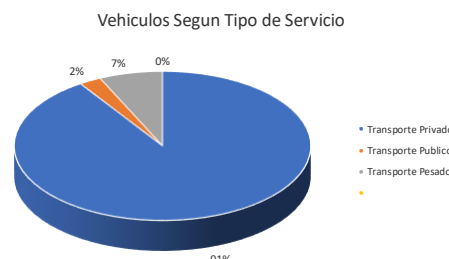
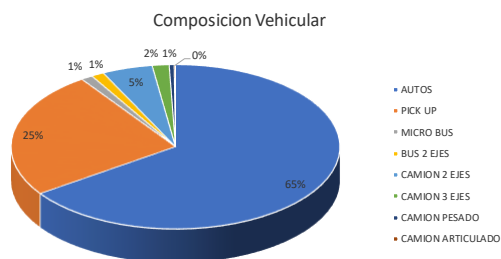



FLUJOGRAMA VEHICULAR CLASIFICADO
FLUJOS DIRECCIONALES

INTERSECCION: AV. SAN MARTIN -CA. CONFRATERNIDAD DISTRITO: CUSCO
 FECHA: MIERCOLES TURNO: Mañana
 DÍA: MIERCOLES
 HORA : 07:30 - 08:30

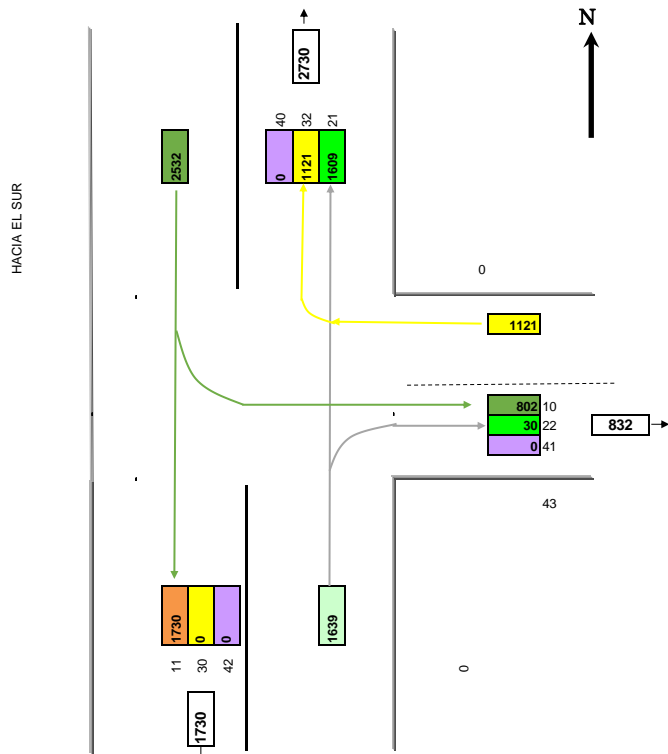

	10	11	12	13	20	21	22	23	30	31	32	33	40	41	42	43
AUTOS	546	990	0	0	0	841	17	0	0	0	670	0	0	0	0	0
PICK UP	208	432	0	0	0	432	7	0	0	0	348	0	0	0	0	0
MICRO BUS	0	58	0	0	0	52	0	0	0	0	7	0	0	0	0	0
BUS 2 EJES	2	13	0	0	0	12	0	0	0	0	0	0	0	0	0	0
CAMION 2 EJES	10	28	0	0	0	38	2	0	0	0	21	0	0	0	0	0
CAMION 3 EJES	4	14	0	0	0	14	0	0	0	0	4	0	0	0	0	0
CAMION PESADO	0	6	0	0	0	9	0	0	0	0	3	0	0	0	0	0
CAMION ARTICULADO	0	2	0	0	0	2	0	0	0	0	0	0	0	0	0	0
TOTAL	770	1543	0	0	0	1400	26	0	0	0	1053	0	0	0	0	0
UCP	802	1730	0	0	0	1609	30	0	0	0	1121	0	0	0	0	0
TOTAL INTERSECCION	4792															
UCP INTERSECCION	5292															

	10	11	12	13	20	21	22	23	30	31	32	33	40	41	42	43
Autos	754	1422	0	0	0	1273	24	0	0	0	1018	0	0	0	0	0
T.U	2	71	0	0	0	64	0	0	0	0	7	0	0	0	0	0
Camion		50	0	0	0	63	2	0	0	0	28	0	0	0	0	0
Mototaxi																
TOTAL	756	1543	0	0	0	1400	26	0	0	0	1053	0	0	0	0	0
%	16%	32%	0%	0%	0%	29%	1%	0%	0%	0%	22%	0%	0%	0%	0%	0%

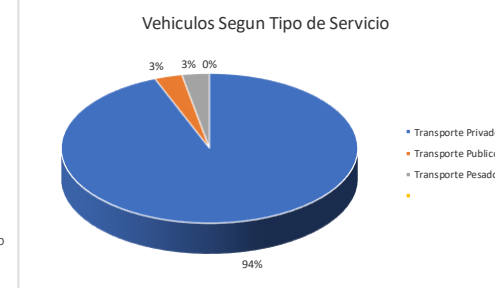
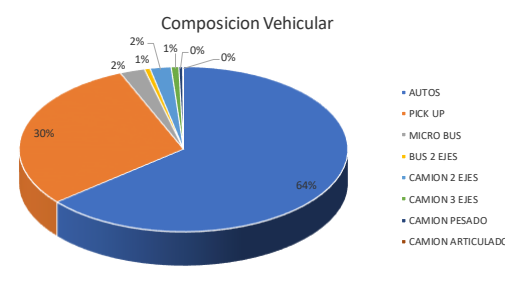



**FLUJOGRAMA VEHICULAR CLASIFICADO
FLUJOS DIRECCIONALES**

INTERSECCION: AV. VALLEJOS SANTONI-OVALO PACHACUTEC DISTRITO: CUSCO
 FECHA: MIERCOLES TURNO: Mañana
 DÍA: MIERCOLES
 HORA : 07:30 - 08:30

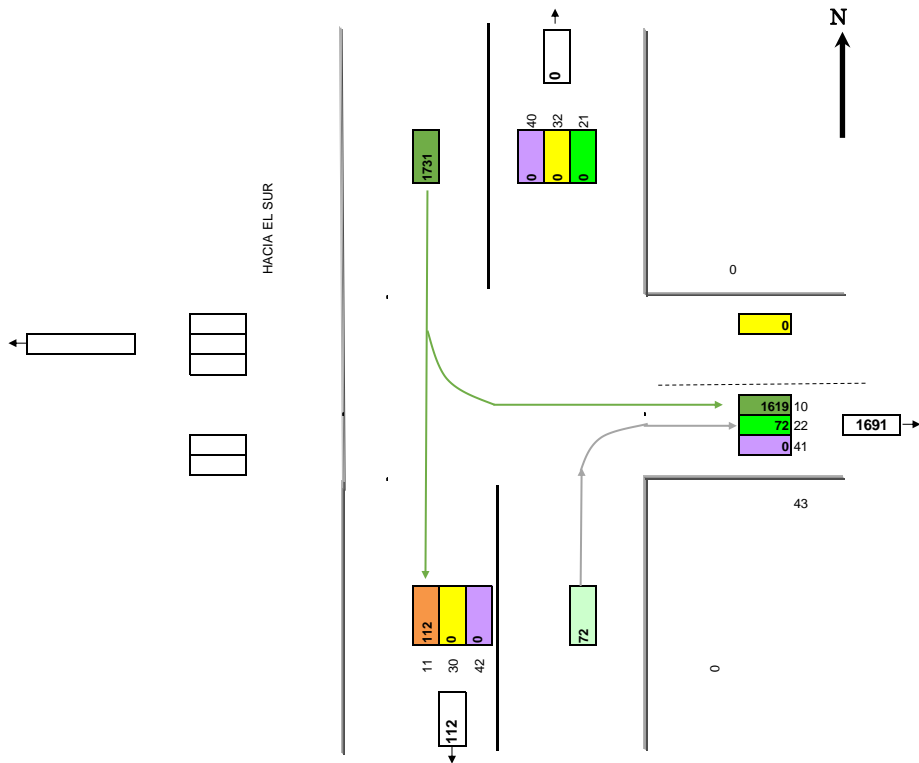

	10	11	12	13	20	21	22	23	30	31	32	33	40	41	42	43
AUTOS	970	36	0	0	0	0	26	0	0	0	0	0	0	0	0	0
PICK UP	363	18	0	0	0	0	10	0	0	0	0	0	0	0	0	0
MICRO BUS	55	7	0	0	0	0	3	0	0	0	0	0	0	0	0	0
BUS 2 EJES	11	5	0	0	0	0	2	0	0	0	0	0	0	0	0	0
CAMION 2 EJES	24	10	0	0	0	0	6	0	0	0	0	0	0	0	0	0
CAMION 3 EJES	14	1	0	0	0	0	1	0	0	0	0	0	0	0	0	0
CAMION PESADO	6	0	0	0	0	0	1	0	0	0	0	0	0	0	0	0
CAMION ARTICULADO	2	0	0	0	0	0	0	0	0	0	0	0	0	0	0	0
TOTAL	1445	77	0	0	0	0	49	0	0	0	0	0	0	0	0	0
UCP	1619	112	0	0	0	0	72	0	0	0	0	0	0	0	0	0
TOTAL INTERSECCION	1571															
UCP INTERSECCION	1802															

	10	11	12	13	20	21	22	23	30	31	32	33	40	41	42	43
Autos	1333	54	0	0	0	0	36	0	0	0	0	0	0	0	0	0
T.U	66	12	0	0	0	0	5	0	0	0	0	0	0	0	0	0
Camion		11	0	0	0	0	8	0	0	0	0	0	0	0	0	0
Mototaxi																
TOTAL	1399	77	0	0	0	0	49	0	0	0	0	0	0	0	0	0
%	92%	5%	0%	0%	0%	0%	3%	0%	0%	0%	0%	0%	0%	0%	0%	0%

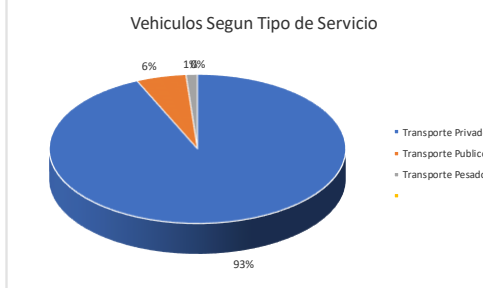
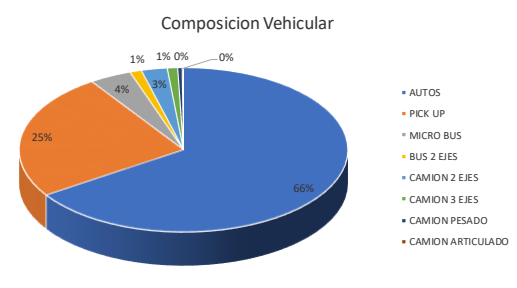



FLUJOGRAMA VEHICULAR CLASIFICADO FLUJOS DIRECCIONALES

INTERSECCION: ACCESO TERMINAL- OVALO PACHACUTEK
FECHA: MIERCOLES
HORA: 07:30 - 08:30

DISTRITO: CUSCO
TURNO: Mañana

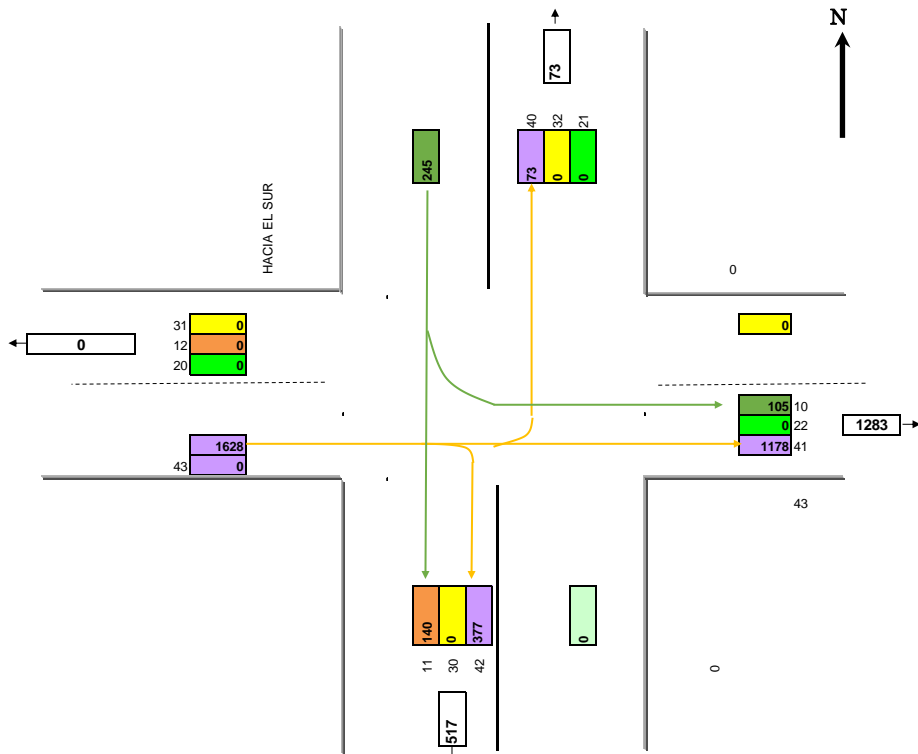
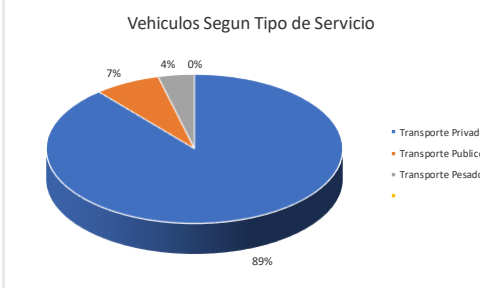
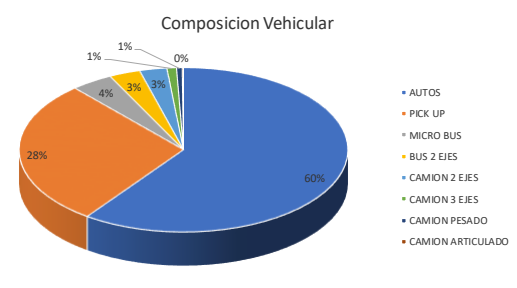

Table with 16 columns representing different directions and rows for vehicle types: AUTOS, PICK UP, MICRO BUS, BUS 2 EJES, CAMION 2 EJES, CAMION 3 EJES, CAMION PESADO, CAMION ARTICULADO, TOTAL, UCP, and UCP INTERSECCION.

Table with 16 columns representing different directions and rows for vehicle types: Autos, T.U, Camion, Mototaxi, TOTAL, and %.





FLUJOGRAMA VEHICULAR CLASIFICADO
FLUJOS DIRECCIONALES

INTERSECCION: AV. MATEO PUMACAHUA-OVALO PACHACUTEC-AV. MICAELA I
 FECHA: MIERCOLES
 DÍA: MIERCOLES
 HORA: 07:30 - 08:30

DISTRITO: CUSCO
 TURNO: Mañana

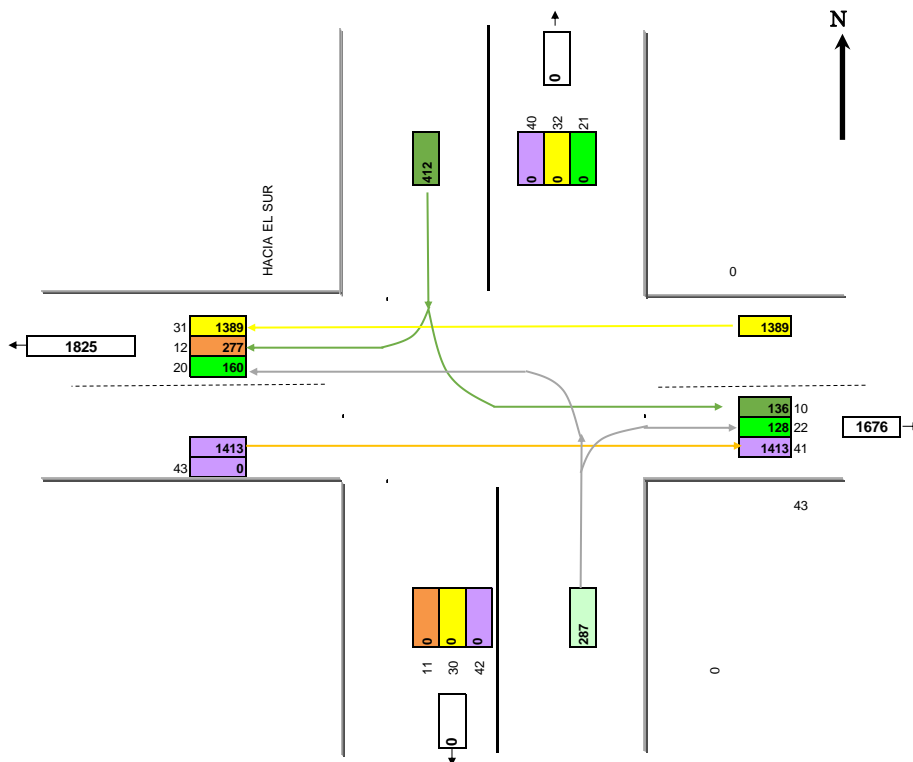

	10	11	12	13	20	21	22	23	30	31	32	33	40	41	42	43
AUTOS	89	0	173	0	84	0	61	0	0	669	0	0	0	840	0	0
PICK UP	24	0	54	0	17	0	22	0	0	311	0	0	0	326	0	0
MICRO BUS	0	0	0	0	10	0	0	0	0	20	0	0	0	47	0	0
BUS 2 EJES	2	0	6	0	4	0	4	0	0	11	0	0	0	7	0	0
CAMION 2 EJES	5	0	9	0	5	0	6	0	0	64	0	0	0	20	0	0
CAMION 3 EJES	1	0	3	0	1	0	3	0	0	29	0	0	0	13	0	0
CAMION PESADO	0	0	0	0	3	0	2	0	0	11	0	0	0	6	0	0
CAMION ARTICULADO	0	0	0	0	0	0	0	0	0	2	0	0	0	2	0	0
TOTAL	121	0	245	0	124	0	98	0	0	1117	0	0	0	1261	0	0
UCP	136	0	277	0	160	0	128	0	0	1389	0	0	0	1413	0	0
TOTAL INTERSECCION	2966															
UCP INTERSECCION	3500															

	10	11	12	13	20	21	22	23	30	31	32	33	40	41	42	43
Autos	113	0	227	0	101	0	83	0	0	980	0	0	0	1166	0	0
T.U	2	0	6	0	14	0	4	0	0	31	0	0	0	54	0	0
Camion			12	0	9	0	11	0	0	106	0	0	0	41	0	0
Mototaxi																
TOTAL	115	0	245	0	124	0	98	0	0	1117	0	0	0	1261	0	0
%	4%	0%	8%	0%	4%	0%	3%	0%	0%	38%	0%	0%	0%	43%	0%	0%

Composicion Vehicular

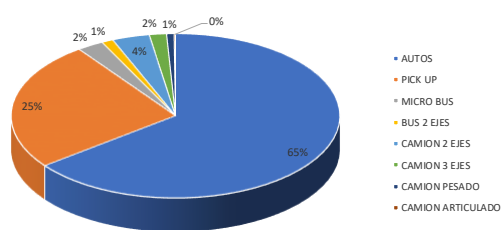

Vehiculos Segun Tipo de Servicio

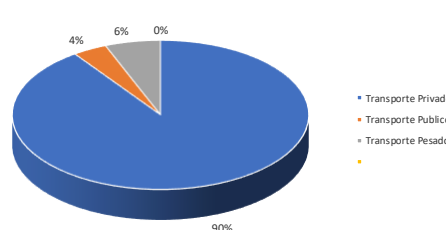



FLUJOGRAMA VEHICULAR CLASIFICADO
FLUJOS DIRECCIONALES

INTERSECCION: AV. LA PAZ-OVALO PACHACUTEQ DISTRITO: CUSCO
 FECHA: MIERCOLES TURNO: Mañana
 HORA: 07:30 - 08:30

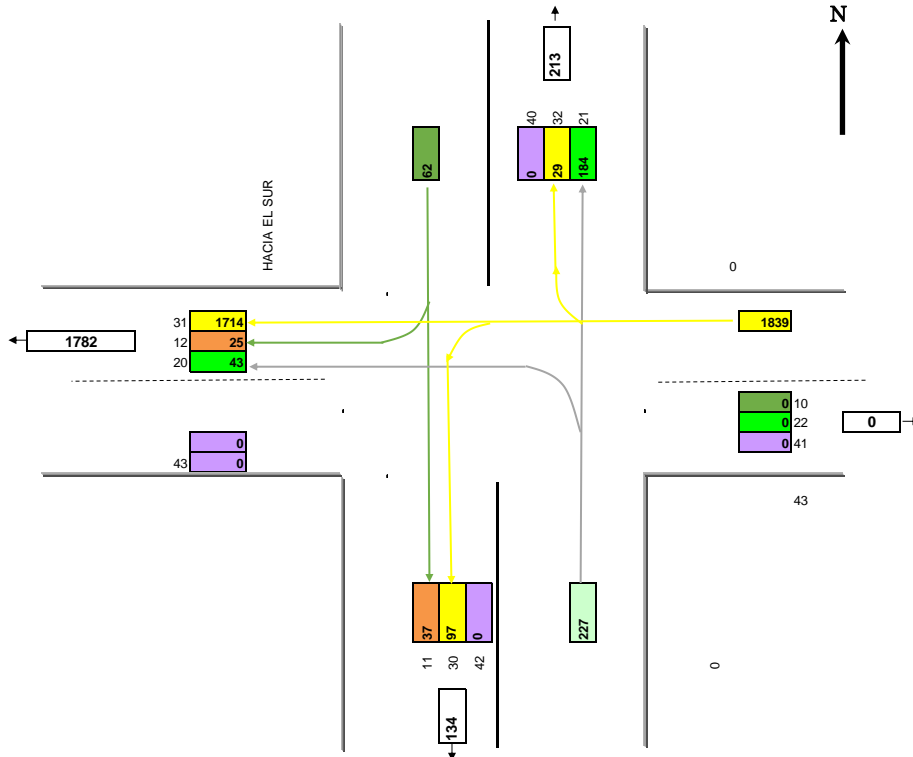

	10	11	12	13	20	21	22	23	30	31	32	33	40	41	42	43
AUTOS	0	19	12	0	20	93	0	0	50	847	16	0	0	0	0	0
PICK UP	0	9	7	0	9	48	0	0	22	416	7	0	0	0	0	0
MICRO BUS	0	0	0	0	0	0	0	0	0	41	0	0	0	0	0	0
BUS 2 EJES	0	0	0	0	1	4	0	0	0	11	0	0	0	0	0	0
CAMION 2 EJES	0	3	2	0	4	8	0	0	7	64	2	0	0	0	0	0
CAMION 3 EJES	0	0	0	0	0	3	0	0	1	29	0	0	0	0	0	0
CAMION PESADO	0	0	0	0	0	0	0	0	0	11	0	0	0	0	0	0
CAMION ARTICULADO	0	0	0	0	0	0	0	0	0	2	0	0	0	0	0	0
TOTAL	0	31	21	0	34	156	0	0	80	1421	25	0	0	0	0	0
UCP	0	37	25	0	43	184	0	0	97	1714	29	0	0	0	0	0
TOTAL INTERSECCION		1768														
UCP INTERSECCION		2128														

	10	11	12	13	20	21	22	23	30	31	32	33	40	41	42	43
Autos	0	28	19	0	29	141	0	0	72	1263	23	0	0	0	0	0
T.U	0	0	0	0	1	4	0	0	0	52	0	0	0	0	0	0
Camion		3	2	0	4	11	0	0	8	106	2	0	0	0	0	0
Mototaxi																
TOTAL	0	31	21	0	34	156	0	0	80	1421	25	0	0	0	0	0
%	0%	2%	1%	0%	2%	9%	0%	0%	5%	80%	1%	0%	0%	0%	0%	0%

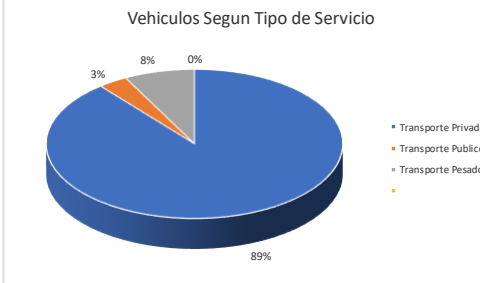
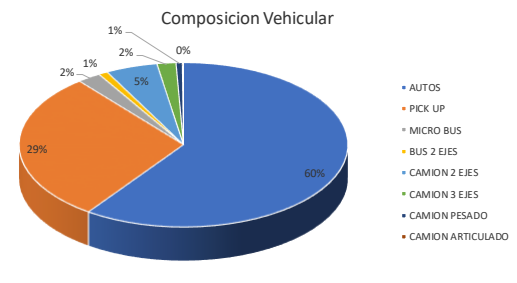



FLUJOGRAMA VEHICULAR CLASIFICADO
FLUJOS DIRECCIONALES

INTERSECCION: AV. INFANCIA - OVALO DE PACHACUTEQ DISTRITO: CUSCO
FECHA: MIERCOLES TURNO: Mañana
DÍA: MIERCOLES
HORA: 07:30 - 08:30

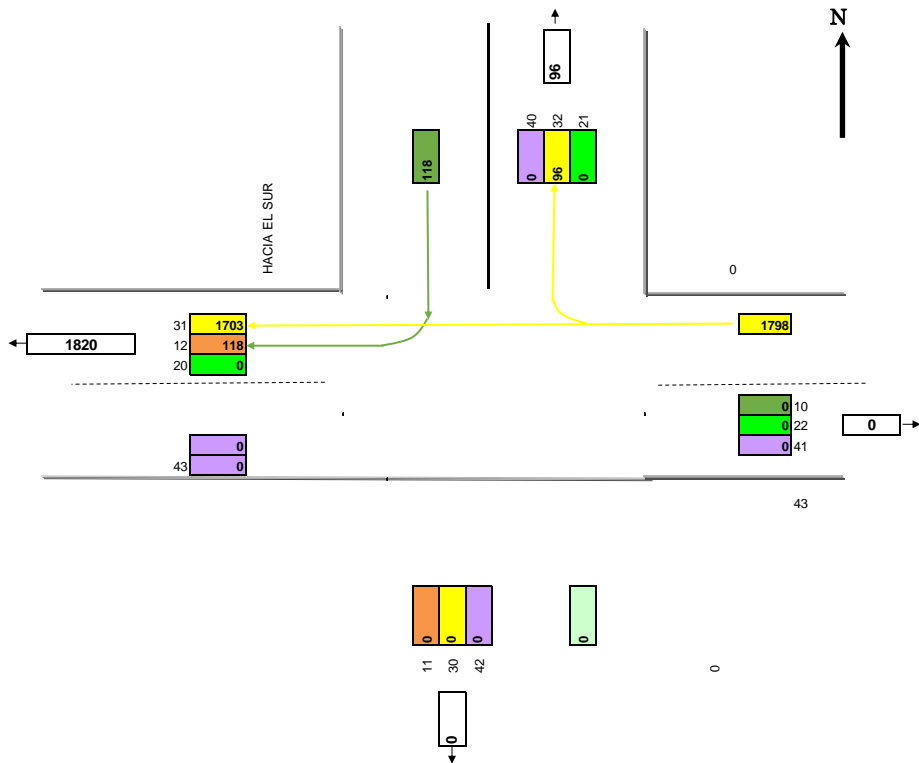

	10	11	12	13	20	21	22	23	30	31	32	33	40	41	42	43
AUTOS	0	0	52	0	0	0	0	0	0	903	42	0	0	0	0	0
PICK UP	0	0	13	0	0	0	0	0	0	359	20	0	0	0	0	0
MICRO BUS	0	0	0	0	0	0	0	0	0	40	6	0	0	0	0	0
BUS 2 EJES	0	0	6	0	0	0	0	0	0	14	0	0	0	0	0	0
CAMION 2 EJES	0	0	10	0	0	0	0	0	0	71	6	0	0	0	0	0
CAMION 3 EJES	0	0	3	0	0	0	0	0	0	16	1	0	0	0	0	0
CAMION PESADO	0	0	0	0	0	0	0	0	0	8	0	0	0	0	0	0
CAMION ARTICULADO	0	0	0	0	0	0	0	0	0	7	0	0	0	0	0	0
TOTAL	0	0	84	0	0	0	0	0	0	1418	75	0	0	0	0	0
UCP	0	0	118	0	0	0	0	0	0	1703	96	0	0	0	0	0
TOTAL INTERSECCION			1577													
UCP INTERSECCION			1916													

	10	11	12	13	20	21	22	23	30	31	32	33	40	41	42	43
Autos	0	0	65	0	0	0	0	0	0	1262	62	0	0	0	0	0
T.U	0	0	6	0	0	0	0	0	0	54	6	0	0	0	0	0
Camion			13	0	0	0	0	0	0	102	7	0	0	0	0	0
Mototaxi																
TOTAL	0	0	84	0	0	0	0	0	0	1418	75	0	0	0	0	0
%	0%	0%	5%	0%	0%	0%	0%	0%	0%	90%	5%	0%	0%	0%	0%	0%

Composicion Vehicular

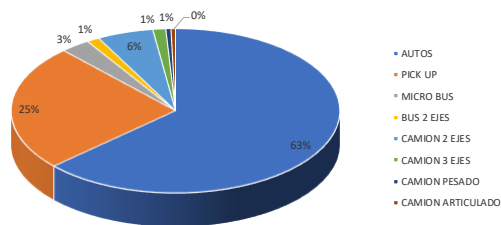

Vehiculos Segun Tipo de Servicio

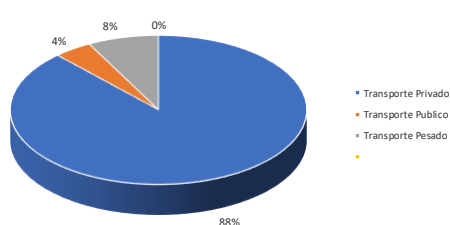



FLUJOGRAMA VEHICULAR CLASIFICADO FLUJOS DIRECCIONALES

INTERSECCION: AV. 28 DE JULIO-CA. LA UNION- JR. LOS SAUCES
FECHA: MIERCOLES
DIA: MIERCOLES
HORA: 07:30 - 08:30

DISTRITO: CUSCO
TURNO: Mañana

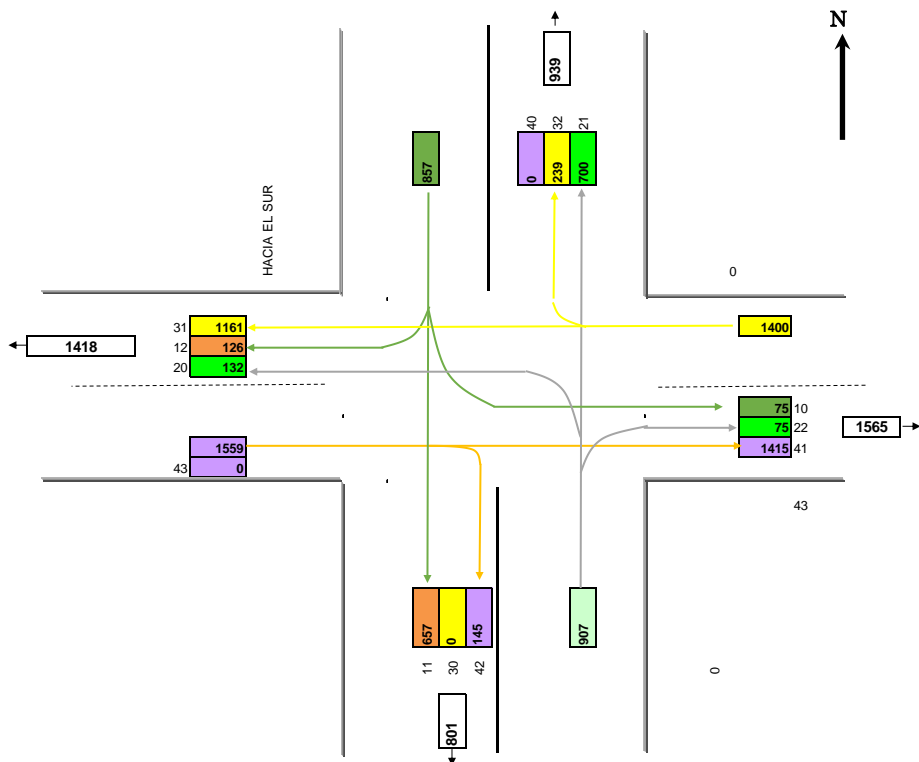

	10	11	12	13	20	21	22	23	30	31	32	33	40	41	42	43
AUTOS	11	331	64	0	72	361	42	0	0	519	86	0	0	842	76	0
PICK UP	7	173	20	0	34	176	17	0	0	258	45	0	0	326	27	0
MICRO BUS	10	9	0	0	0	16	0	0	0	15	12	0	0	47	6	0
BUS 2 EJES	2	8	1	0	1	5	2	0	0	11	5	0	0	7	1	0
CAMION 2 EJES	11	36	12	0	8	38	4	0	0	59	20	0	0	20	8	0
CAMION 3 EJES	0	3	1	0	0	2	0	0	0	29	4	0	0	13	1	0
CAMION PESADO	0	0	0	0	0	0	0	0	0	11	0	0	0	6	0	0
CAMION ARTICULADO	0	0	0	0	0	0	0	0	0	2	0	0	0	2	0	0
TOTAL	41	560	98	0	115	598	65	0	0	904	172	0	0	1263	119	0
UCP	75	657	126	0	132	700	75	0	0	1161	239	0	0	1415	145	0
TOTAL INTERSECCION																
UCP INTERSECCION																

	10	11	12	13	20	21	22	23	30	31	32	33	40	41	42	43
Autos	18	504	84	0	106	537	59	0	0	777	131	0	0	1168	103	0
T.U	12	17	1	0	1	21	2	0	0	26	17	0	0	54	7	0
Camion		39	13	0	8	40	4	0	0	101	24	0	0	41	9	0
Mototaxi																
TOTAL	30	560	98	0	115	598	65	0	0	904	172	0	0	1263	119	0
%	1%	14%	2%	0%	3%	15%	2%	0%	0%	23%	4%	0%	0%	32%	3%	0%

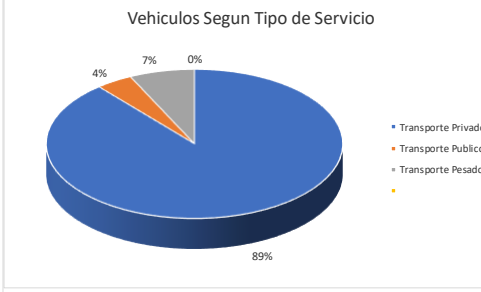
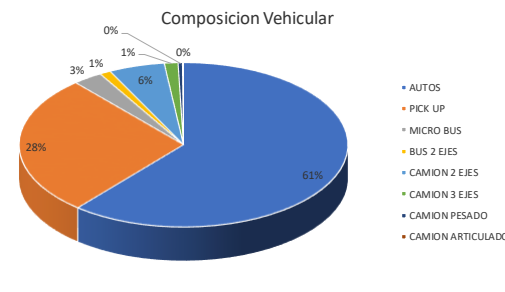



FLUJOGRAMA VEHICULAR CLASIFICADO
FLUJOS DIRECCIONALES

INTERSECCION: AV. 28 DE JULIO-AV. VELASCO-VIA EXPRESA-AV. QOSQO
 FECHA: MIERCOLES
 DÍA: MIERCOLES
 HORA: 07:30 - 08:30

DISTRITO: CUSCO
 TURNO: Mañana

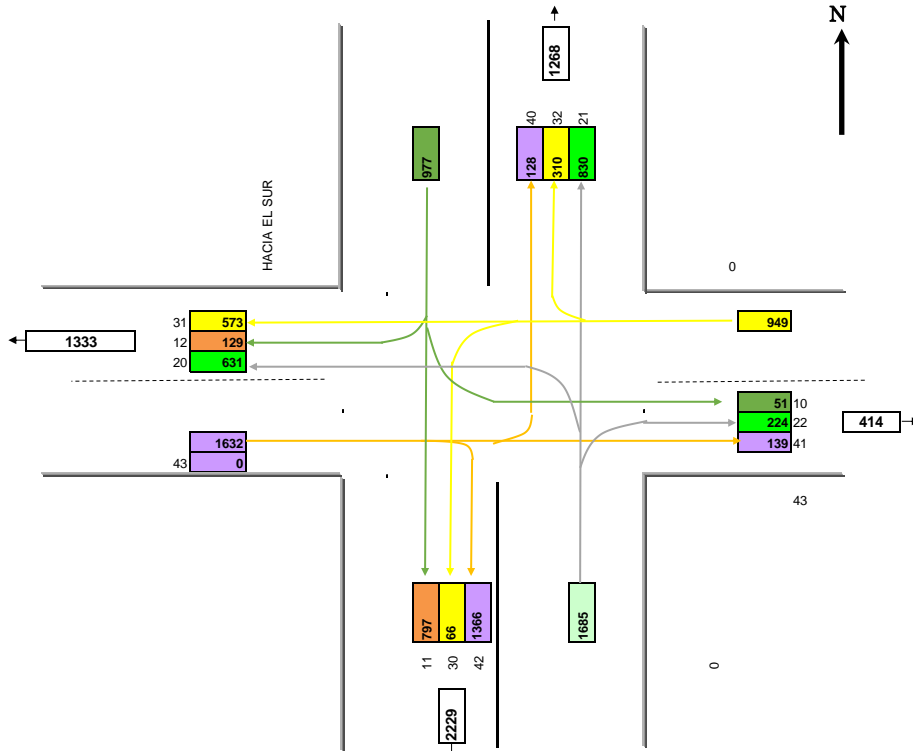

	10	11	12	13	20	21	22	23	30	31	32	33	40	41	42	43
AUTOS	21	447	45	0	317	496	82	0	24	266	193	0	57	43	682	0
PICK UP	8	225	21	0	164	229	43	0	20	129	93	0	28	18	338	0
MICRO BUS	0	8	6	0	10	0	0	0	0	0	0	0	10	0	28	0
BUS 2 EJES	2	5	4	0	10	15	8	0	2	10	0	0	1	0	11	0
CAMION 2 EJES	6	26	12	0	15	25	12	0	6	31	8	0	7	13	53	0
CAMION 3 EJES	0	6	2	0	9	0	11	0	0	9	0	0	0	5	19	0
CAMION PESADO	0	0	0	0	5	0	1	0	0	6	0	0	0	3	6	0
CAMION ARTICULADO	0	0	0	0	3	0	1	0	0	2	0	0	0	2	4	0
TOTAL	37	717	90	0	533	765	158	0	52	453	294	0	103	84	1141	0
UCP	51	797	129	0	631	830	224	0	66	573	310	0	128	139	1366	0
TOTAL INTERSECCION		4427														
UCP INTERSECCION		5243														

	10	11	12	13	20	21	22	23	30	31	32	33	40	41	42	43
Autos	29	672	66	0	481	725	125	0	44	395	286	0	85	61	1020	0
T.U	2	13	10	0	20	15	8	0	2	10	0	0	11	0	39	0
Camion		32	14	0	32	25	25	0	6	48	8	0	7	23	82	0
Mototaxi																
TOTAL	31	717	90	0	533	765	158	0	52	453	294	0	103	84	1141	0
%	1%	16%	2%	0%	12%	17%	4%	0%	1%	10%	7%	0%	2%	2%	26%	0%

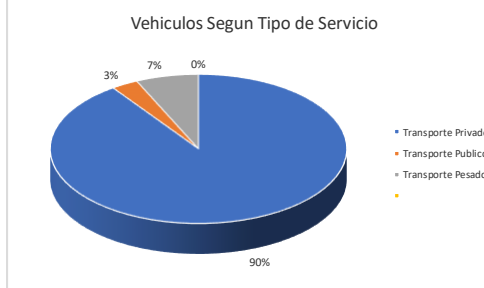
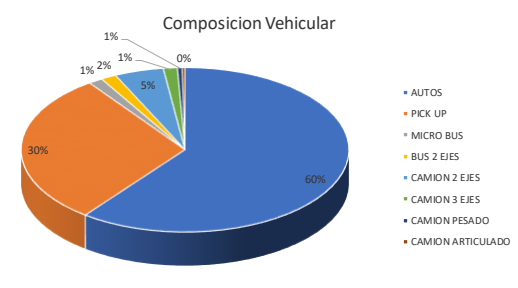

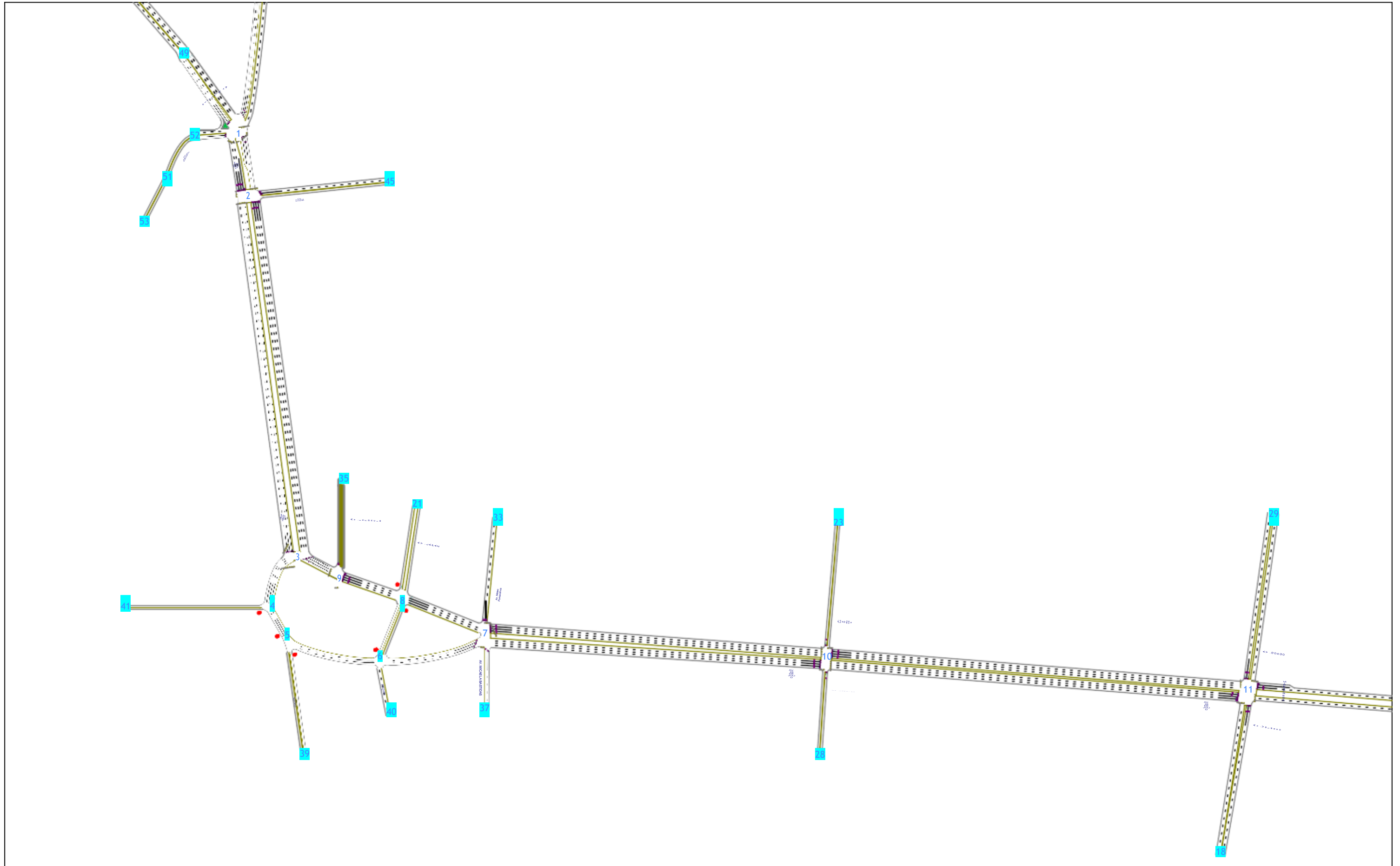

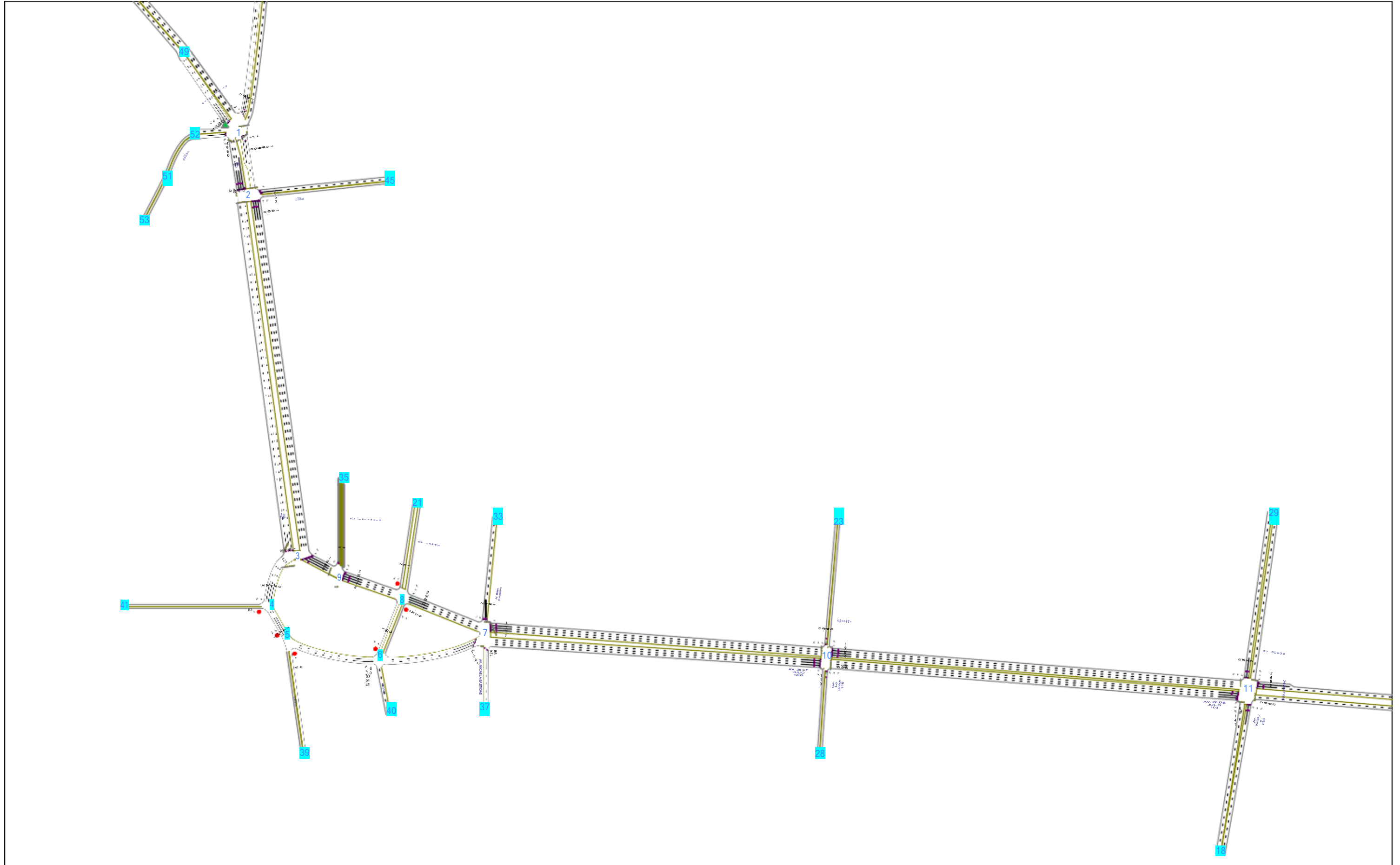

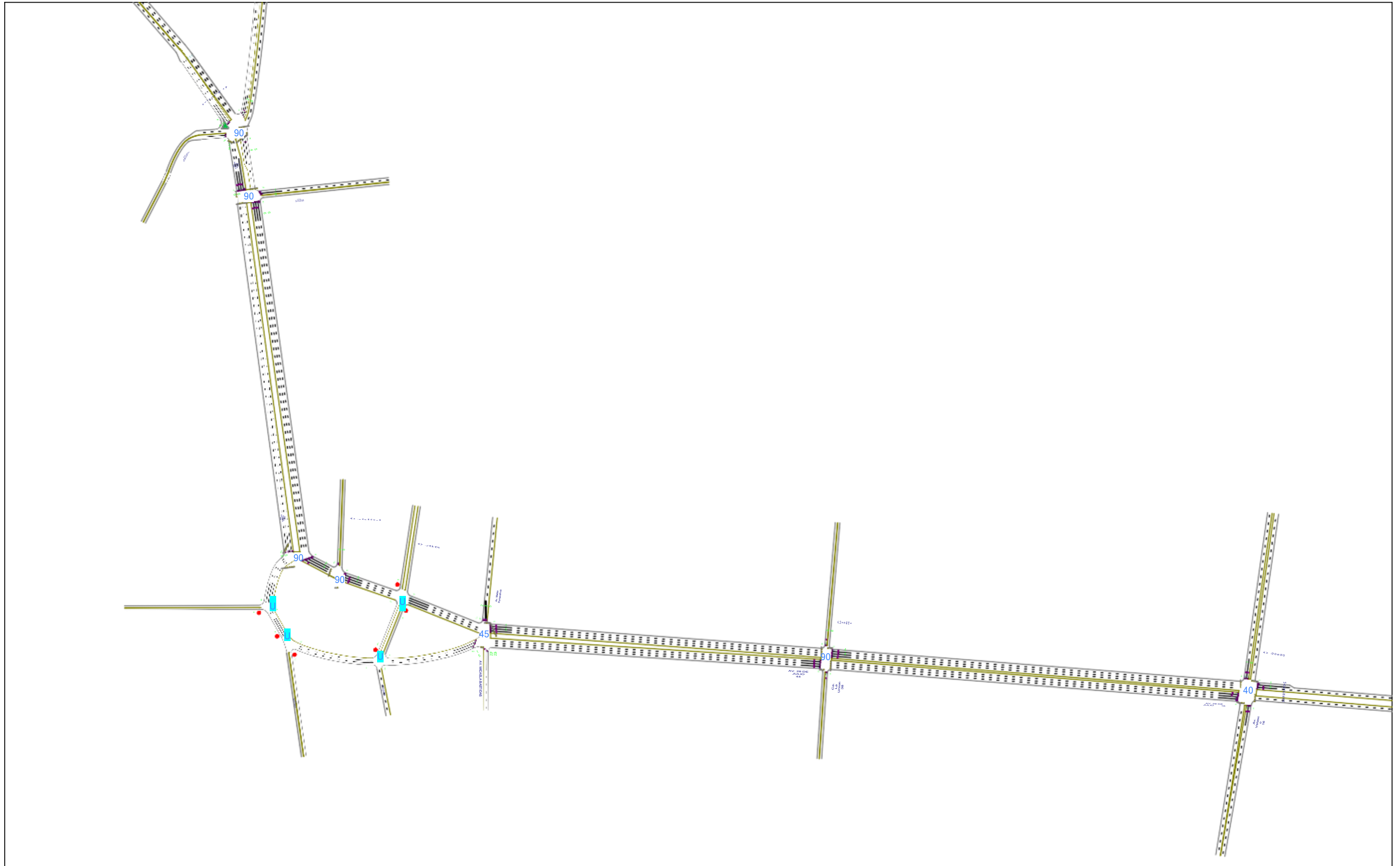

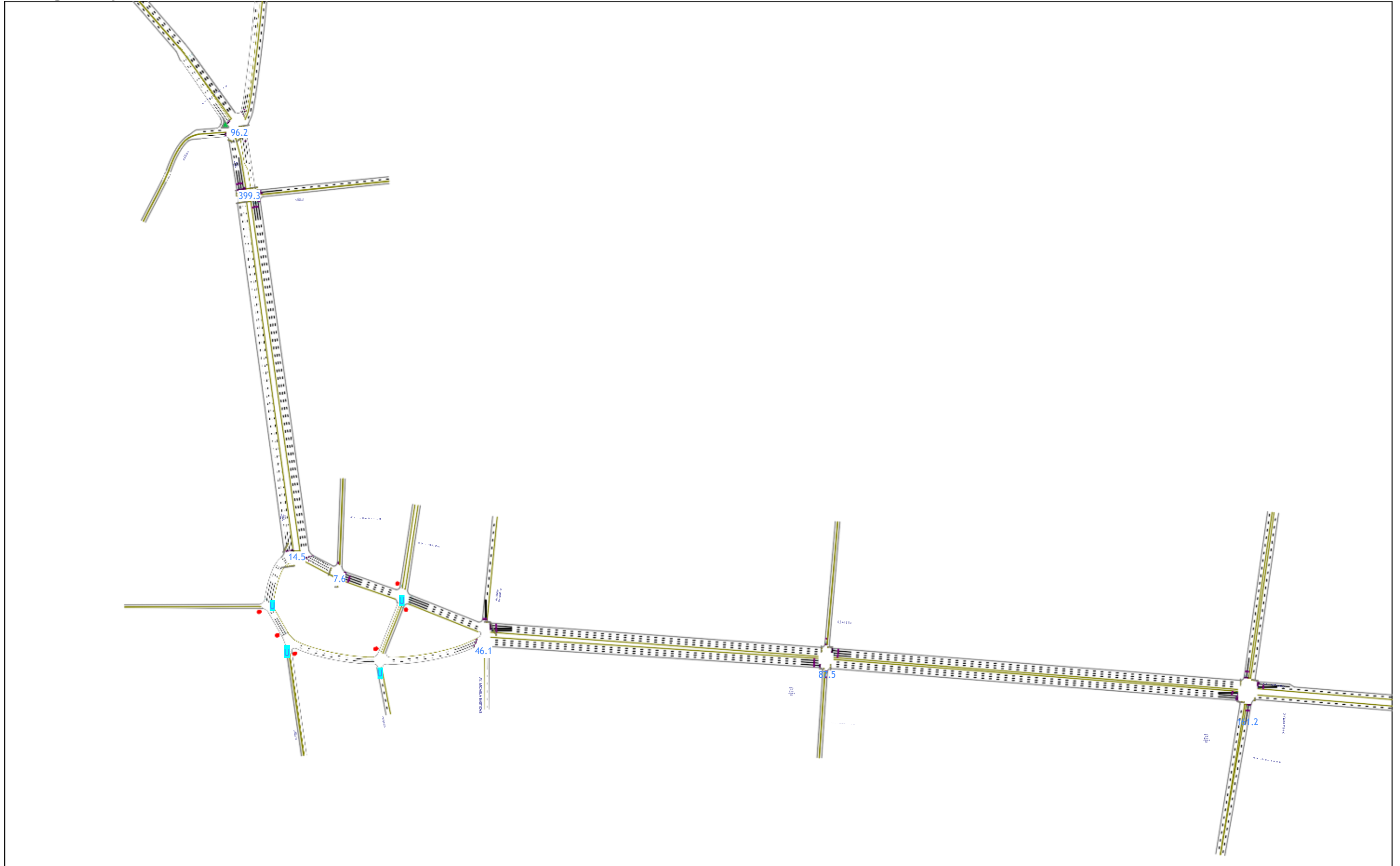

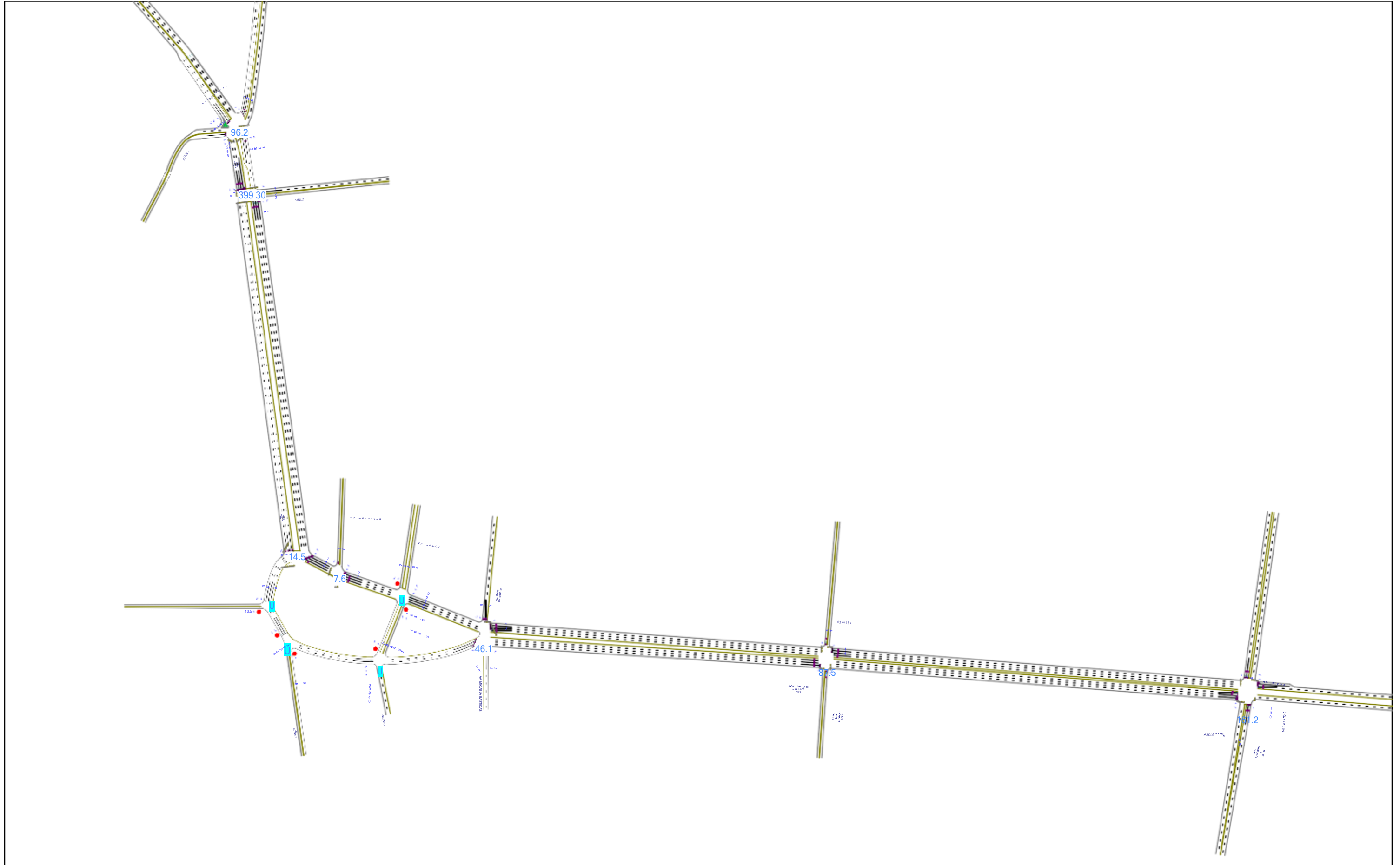



ICU % ACTUAL
Intersection Capacity Utilization

16/08/2021

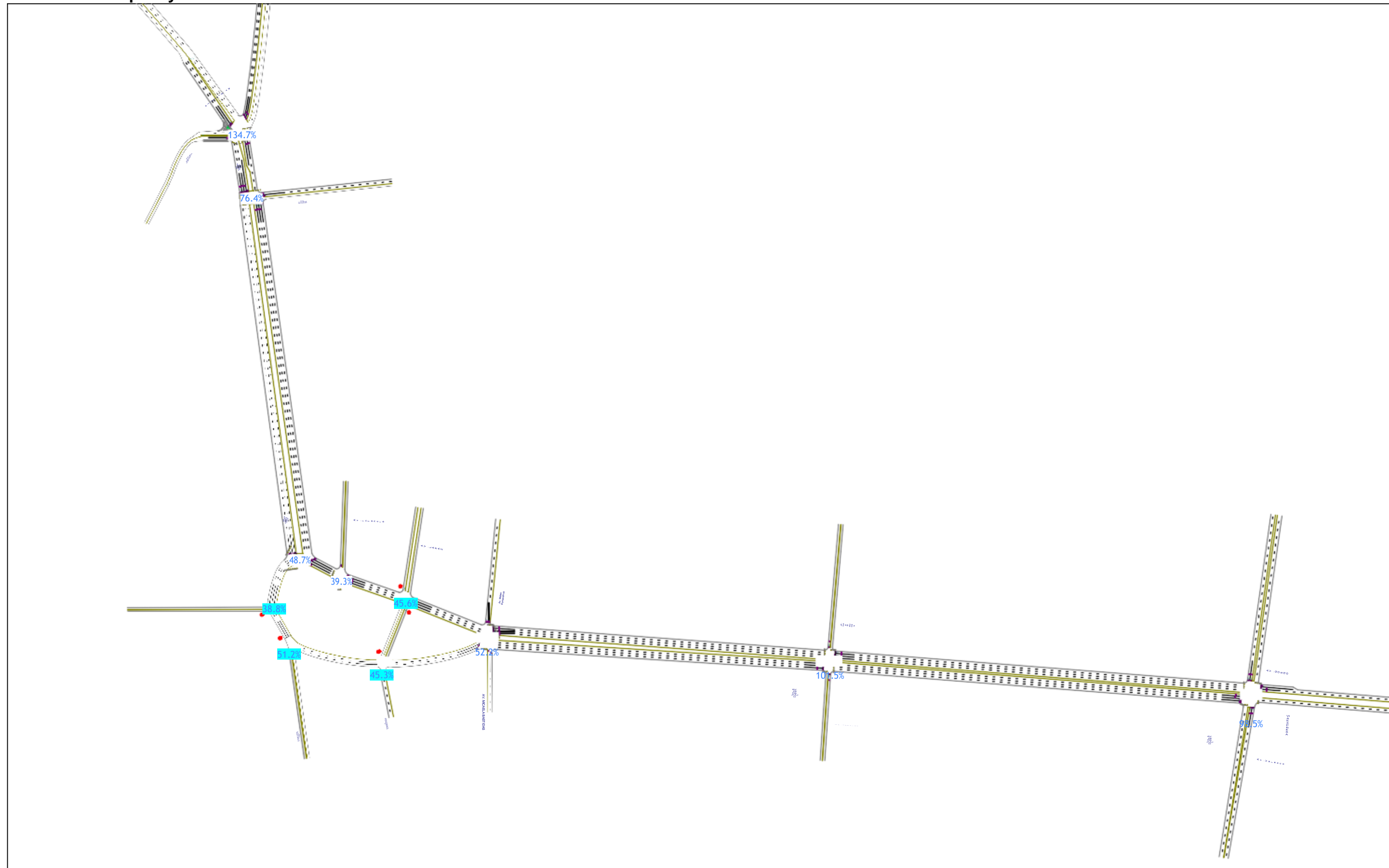

ANALISIS DE OVALOS Baseline 2021

12:00 am 22/03/2021

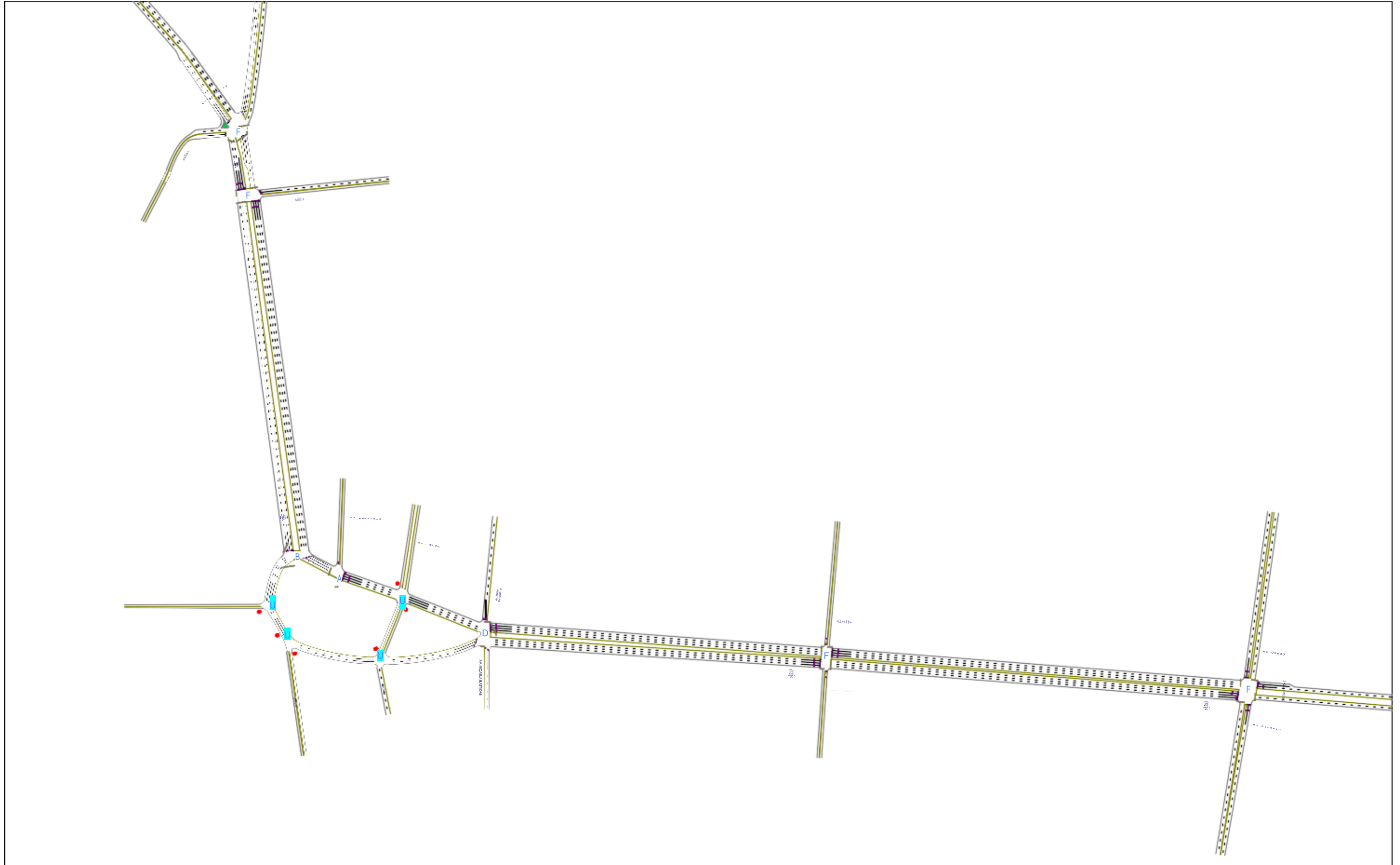

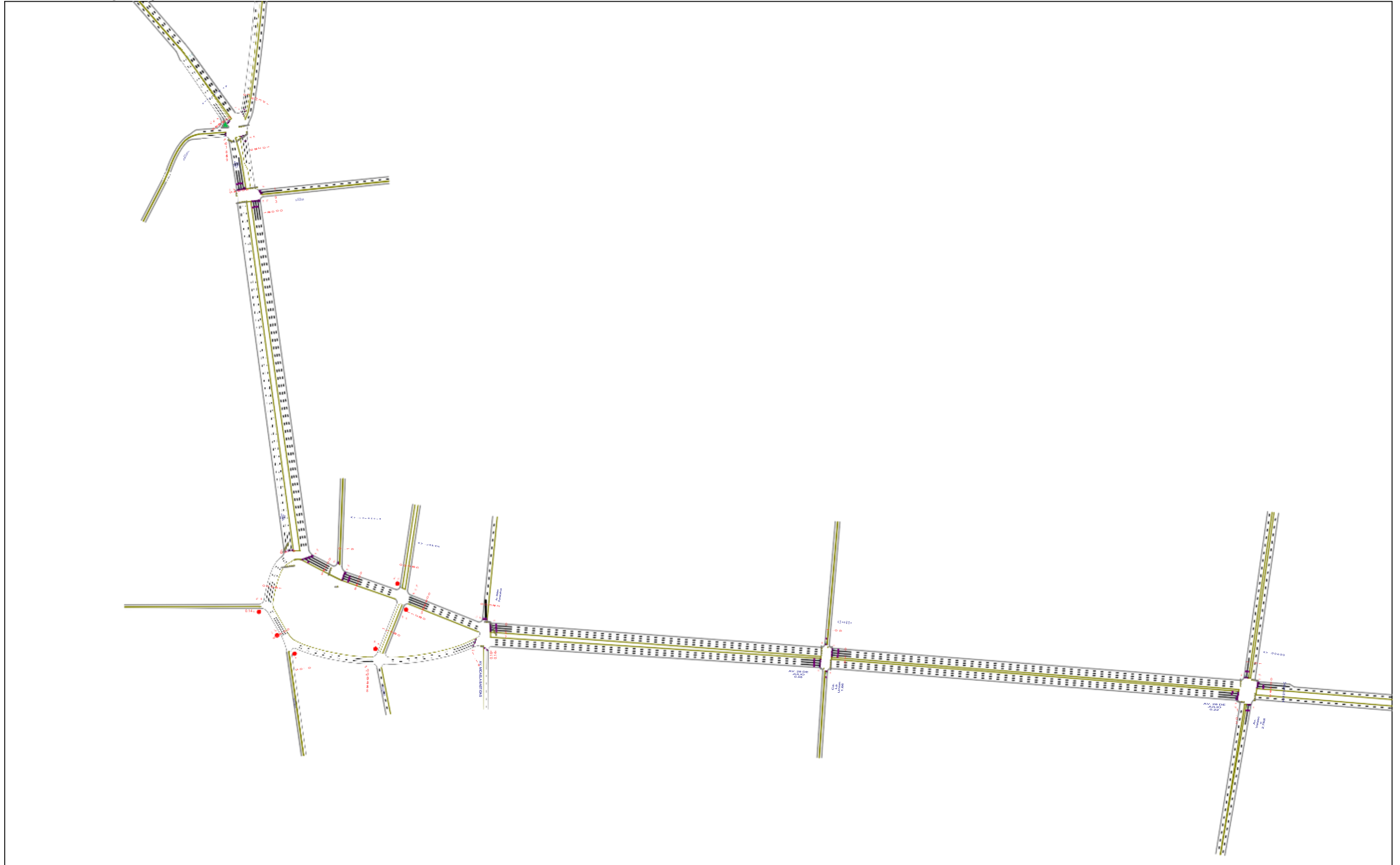



Lane Group	EBL	EBR	NBL2	NBL	NBT	SBT	SBR	SBR2	SEL	SER	SER2
Lane Configurations											
Traffic Volume (vph)	444	698	130	840	1399	0	212	756	76	1501	76
Future Volume (vph)	444	698	130	840	1399	0	212	756	76	1501	76
Ideal Flow (vphpl)	1900	1900	1900	1900	1900	1900	1900	1900	1900	1900	1900
Lane Width (m)	3.6	3.6	3.6	3.6	3.6	2.7	2.7	2.7	3.6	3.6	3.6
Storage Length (m)	0.0	0.0		40.0			0.0		0.0	0.0	
Storage Lanes	1	1		1			1		1	2	
Taper Length (m)	7.5			10.0					7.5		
Lane Util. Factor	1.00	1.00	0.91	0.91	0.91	0.91	0.91	0.91	1.00	0.95	1.00
Fr _t		0.850				0.850		0.850	0.864	0.850	0.850
Fl _t Protected	0.950		0.950		0.981				0.995		
Satd. Flow (prot)	1770	1583	1610	0	3326	2594	0	1297	1601	1504	1583
Fl _t Permitted	0.950		0.139		0.949				0.995		
Satd. Flow (perm)	1770	1583	236	0	3217	2594	0	1297	1601	1504	1583
Right Turn on Red		Yes						Yes			No
Satd. Flow (RTOR)		27				147		147			
Link Speed (k/h)	50				50	50			50		
Link Distance (m)	69.3				100.4	313.3			152.6		
Travel Time (s)	5.0				7.2	22.6			11.0		
Peak Hour Factor	0.92	0.92	0.92	0.92	0.92	0.92	0.92	0.92	0.92	0.92	0.92
Adj. Flow (vph)	483	759	141	913	1521	0	230	822	83	1632	83
Shared Lane Traffic (%)			10%					50%		48%	
Lane Group Flow (vph)	483	759	127	0	2448	641	0	411	866	849	83
Enter Blocked Intersection	No	No	No	No	No	No	No	No	No	No	No
Lane Alignment	Left	Right	Left	Left	Left	Left	Right	Right	Left	Right	Right
Median Width(m)	3.6				10.0	3.6			8.0		
Link Offset(m)	0.0				0.0	0.0			0.0		
Crosswalk Width(m)	4.8				4.8	4.8			4.8		
Two way Left Turn Lane											
Headway Factor	1.00	1.00	1.00	1.00	1.00	1.14	1.14	1.14	1.00	1.00	1.00
Turning Speed (k/h)	25	15	25	25			15	15	25	15	15
Turn Type	Prot	Perm	Perm	Perm	NA	NA		Perm	Prot	Perm	Perm
Protected Phases	4!				2!	4!			6!		
Permitted Phases		4	2	2!				4		6	6
Minimum Split (s)	20.0	20.0	20.0	20.0	20.0	20.0		20.0	20.0	20.0	20.0
Total Split (s)	32.0	32.0	58.0	58.0	58.0	32.0		32.0	58.0	58.0	58.0
Total Split (%)	35.6%	35.6%	64.4%	64.4%	64.4%	35.6%		35.6%	64.4%	64.4%	64.4%
Maximum Green (s)	28.0	28.0	54.0	54.0	54.0	28.0		28.0	54.0	54.0	54.0
Yellow Time (s)	3.5	3.5	3.5	3.5	3.5	3.5		3.5	3.5	3.5	3.5
All-Red Time (s)	0.5	0.5	0.5	0.5	0.5	0.5		0.5	0.5	0.5	0.5
Lost Time Adjust (s)	0.0	0.0	0.0		0.0	0.0		0.0	0.0	0.0	0.0
Total Lost Time (s)	4.0	4.0	4.0		4.0	4.0		4.0	4.0	4.0	4.0
Lead/Lag											
Lead-Lag Optimize?											
Walk Time (s)	5.0	5.0	5.0	5.0	5.0	5.0		5.0	5.0	5.0	5.0
Flash Dont Walk (s)	11.0	11.0	11.0	11.0	11.0	11.0		11.0	11.0	11.0	11.0
Pedestrian Calls (#/hr)	0	0	0	0	0	0		0	0	0	0
Act Effct Green (s)	28.0	28.0	54.0		54.0	28.0		28.0	54.0	54.0	54.0
Actuated g/C Ratio	0.31	0.31	0.60		0.60	0.31		0.31	0.60	0.60	0.60



Lane Group	EBL	EBR	NBL2	NBL	NBT	SBT	SBR	SBR2	SEL	SER	SER2
v/c Ratio	0.88	1.49	0.90		1.27	1.23dr		0.82	0.90	0.94	0.09
Control Delay	48.7	255.2	23.1		136.0	25.7		33.0	30.6	37.2	7.9
Queue Delay	0.0	0.0	0.0		0.0	0.0		0.0	0.0	0.0	0.0
Total Delay	48.7	255.2	23.1		136.0	25.7		33.0	30.6	37.2	7.9
LOS	D	F	C		F	C		C	C	D	A
Approach Delay	174.9				130.4	28.6			32.7		
Approach LOS	F				F	C			C		
Stops (vph)	385	513	41		1607	402		223	628	616	30
Fuel Used(l)	35	164	4		293	38		26	58	61	4
CO Emissions (g/hr)	649	3045	77		5453	712		481	1084	1136	66
NOx Emissions (g/hr)	125	588	15		1052	137		93	209	219	13
VOC Emissions (g/hr)	150	702	18		1258	164		111	250	262	15
Dilemma Vehicles (#)	0	0	0		0	0		0	0	0	0
Queue Length 50th (m)	82.7	~191.0	3.4		~320.1	43.4		49.7	126.0	136.9	5.9
Queue Length 95th (m)	#139.9	#262.2	m#26.0		m#231.4	64.9		#107.5	#219.8	#235.8	11.9
Internal Link Dist (m)	45.3				76.4	289.3			128.6		
Turn Bay Length (m)			40.0								
Base Capacity (vph)	550	511	141		1930	908		504	960	902	949
Starvation Cap Reductn	0	0	0		0	0		0	0	0	0
Spillback Cap Reductn	0	0	0		0	0		0	0	0	0
Storage Cap Reductn	0	0	0		0	0		0	0	0	0
Reduced v/c Ratio	0.88	1.49	0.90		1.27	0.71		0.82	0.90	0.94	0.09

Intersection Summary

Area Type: Other

Cycle Length: 90

Actuated Cycle Length: 90

Offset: 44 (49%), Referenced to phase 2:NBTL and 6:SEL, Start of Green

Natural Cycle: 150

Control Type: Pretimed

Maximum v/c Ratio: 1.49

Intersection Signal Delay: 96.3

Intersection LOS: F

Intersection Capacity Utilization 134.7%

ICU Level of Service H

Analysis Period (min) 15

~ Volume exceeds capacity, queue is theoretically infinite.

Queue shown is maximum after two cycles.

95th percentile volume exceeds capacity, queue may be longer.

Queue shown is maximum after two cycles.

m Volume for 95th percentile queue is metered by upstream signal.dr

Defacto Right Lane. Recode with 1 though lane as a right lane.

! Phase conflict between lane groups.

Splits and Phases: 1: AV. SAN MARTIN & Av. Ejercito

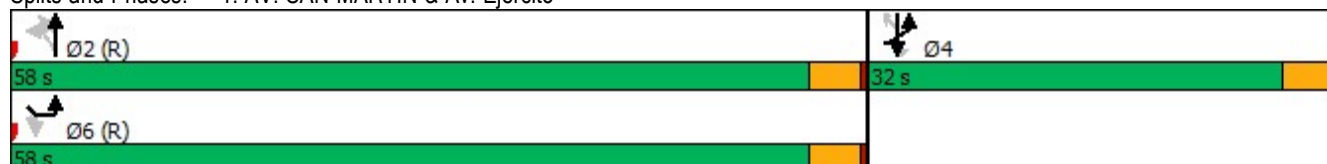



Lane Group	EBL	EBR	NBL2	NBL	NBT	SBT	SBR	SBR2	SEL	SER	SER2
Lane Configurations											
Ideal Flow (vphpl)	1900	1900	1900	1900	1900	1900	1900	1900	1900	1900	1900
Lane Width (m)	3.6	3.6	3.6	3.6	3.6	2.7	2.7	2.7	3.6	3.6	3.6
Grade (%)	0%				0%	0%			0%		
Storage Length (m)	0.0	0.0		40.0			0.0		0.0	0.0	
Storage Lanes	1	1		1			1		1	2	
Taper Length (m)	7.5			10.0					7.5		
Lane Util. Factor	1.00	1.00	0.91	0.91	0.91	0.91	0.91	0.91	1.00	0.95	1.00
Ped Bike Factor											
Frnt		0.850				0.850		0.850	0.864	0.850	0.850
Flt Protected	0.950		0.950		0.981				0.995		
Satd. Flow (prot)	1770	1583	1610	0	3326	2594	0	1297	1601	1504	1583
Flt Permitted	0.950		0.139		0.949				0.995		
Satd. Flow (perm)	1770	1583	236	0	3217	2594	0	1297	1601	1504	1583
Right Turn on Red		Yes						Yes			No
Satd. Flow (RTOR)		27				147		147			
Link Speed (k/h)	50				50	50			50		
Link Distance (m)	69.3				100.4	313.3			152.6		
Travel Time (s)	5.0				7.2	22.6			11.0		

Intersection Summary

Area Type: Other



Lane Group	EBL	EBR	NBL2	NBL	NBT	SBT	SBR	SBR2	SEL	SER	SER2
Traffic Volume (vph)	444	698	130	840	1399	0	212	756	76	1501	76
Future Volume (vph)	444	698	130	840	1399	0	212	756	76	1501	76
Confl. Peds. (#/hr)											
Confl. Bikes (#/hr)											
Peak Hour Factor	0.92	0.92	0.92	0.92	0.92	0.92	0.92	0.92	0.92	0.92	0.92
Growth Factor	100%	100%	100%	100%	100%	100%	100%	100%	100%	100%	100%
Heavy Vehicles (%)	2%	2%	2%	2%	2%	2%	2%	2%	2%	2%	2%
Bus Blockages (#/hr)	0	0	0	0	0	0	0	0	0	0	0
Parking (#/hr)											
Mid-Block Traffic (%)	0%				0%	0%			0%		
Adj. Flow (vph)	483	759	141	913	1521	0	230	822	83	1632	83
Shared Lane Traffic (%)			10%					50%		48%	
Lane Group Flow (vph)	483	759	127	0	2448	641	0	411	866	849	83

Intersection Summary



Lane Group	EBL	EBR	NBL2	NBL	NBT	SBT	SBR2	SEL	SER	SER2
Lane Configurations										
Traffic Volume (vph)	444	698	130	840	1399	0	756	76	1501	76
Future Volume (vph)	444	698	130	840	1399	0	756	76	1501	76
Turn Type	Prot	Perm	Perm	Perm	NA	NA	Perm	Prot	Perm	Perm
Protected Phases	4!				2!	4!		6!		
Permitted Phases		4	2	2!			4		6	6
Detector Phase	4	4	2	2	2	4	4	6	6	6
Switch Phase										
Minimum Initial (s)	4.0	4.0	4.0	4.0	4.0	4.0	4.0	4.0	4.0	4.0
Minimum Split (s)	20.0	20.0	20.0	20.0	20.0	20.0	20.0	20.0	20.0	20.0
Total Split (s)	32.0	32.0	58.0	58.0	58.0	32.0	32.0	58.0	58.0	58.0
Total Split (%)	35.6%	35.6%	64.4%	64.4%	64.4%	35.6%	35.6%	64.4%	64.4%	64.4%
Yellow Time (s)	3.5	3.5	3.5	3.5	3.5	3.5	3.5	3.5	3.5	3.5
All-Red Time (s)	0.5	0.5	0.5	0.5	0.5	0.5	0.5	0.5	0.5	0.5
Lost Time Adjust (s)	0.0	0.0	0.0		0.0	0.0	0.0	0.0	0.0	0.0
Total Lost Time (s)	4.0	4.0	4.0		4.0	4.0	4.0	4.0	4.0	4.0
Lead/Lag										
Lead-Lag Optimize?										
Recall Mode	Max	Max	Max	Max	Max	Max	Max	Max	Max	Max
Act Effect Green (s)	28.0	28.0	54.0		54.0	28.0	28.0	54.0	54.0	54.0
Actuated g/C Ratio	0.31	0.31	0.60		0.60	0.31	0.31	0.60	0.60	0.60
v/c Ratio	0.88	1.49	0.90		1.27	1.23dr	0.82	0.90	0.94	0.09
Control Delay	48.7	255.2	23.1		136.0	25.7	33.0	30.6	37.2	7.9
Queue Delay	0.0	0.0	0.0		0.0	0.0	0.0	0.0	0.0	0.0
Total Delay	48.7	255.2	23.1		136.0	25.7	33.0	30.6	37.2	7.9
LOS	D	F	C		F	C	C	C	D	A
Approach Delay	174.9				130.4	28.6		32.7		
Approach LOS	F				F	C		C		

Intersection Summary

Cycle Length: 90

Actuated Cycle Length: 90

Offset: 44 (49%), Reference d to phase 2:NBTL and 6:SEL, Start of Green

Natural Cycle: 150

Control Type: Pretimed

Maximum v/c Ratio: 1.49

Intersection Signal Delay: 96.3

Intersection LOS: F

Intersection Capacity Utilization 134.7%

ICU Level of Service H

Analysis Period (min) 15

dr Defacto Right Lane. Recode with 1 though lane as a right lane.

! Phase conflict between lane groups.

Splits and Phases: 1: AV. SAN MARTIN & Av. Ejercito





Lane Group	EBL	EBR	NBL2	NBL	NBT	SBT	SBR2	SEL	SER	SER2
Protected Phases	4!				2!	4!		6!		
Permitted Phases		4	2	2!			4		6	6
Minimum Initial (s)	4.0	4.0	4.0	4.0	4.0	4.0	4.0	4.0	4.0	4.0
Minimum Split (s)	20.0	20.0	20.0	20.0	20.0	20.0	20.0	20.0	20.0	20.0
Total Split (s)	32.0	32.0	58.0	58.0	58.0	32.0	32.0	58.0	58.0	58.0
Total Split (%)	35.6%	35.6%	64.4%	64.4%	64.4%	35.6%	35.6%	64.4%	64.4%	64.4%
Maximum Green (s)	28.0	28.0	54.0	54.0	54.0	28.0	28.0	54.0	54.0	54.0
Yellow Time (s)	3.5	3.5	3.5	3.5	3.5	3.5	3.5	3.5	3.5	3.5
All-Red Time (s)	0.5	0.5	0.5	0.5	0.5	0.5	0.5	0.5	0.5	0.5
Lead/Lag										
Lead-Lag Optimize?										
Vehicle Extension (s)	3.0	3.0	3.0	3.0	3.0	3.0	3.0	3.0	3.0	3.0
Minimum Gap (s)	3.0	3.0	3.0	3.0	3.0	3.0	3.0	3.0	3.0	3.0
Time Before Reduce (s)	0.0	0.0	0.0	0.0	0.0	0.0	0.0	0.0	0.0	0.0
Time To Reduce (s)	0.0	0.0	0.0	0.0	0.0	0.0	0.0	0.0	0.0	0.0
Recall Mode	Max	Max	Max	Max	Max	Max	Max	Max	Max	Max
Walk Time (s)	5.0	5.0	5.0	5.0	5.0	5.0	5.0	5.0	5.0	5.0
Flash Dont Walk (s)	11.0	11.0	11.0	11.0	11.0	11.0	11.0	11.0	11.0	11.0
Pedestrian Calls (#/hr)	0	0	0	0	0	0	0	0	0	0
90th %ile Green (s)	28.0	28.0	54.0	54.0	54.0	28.0	28.0	54.0	54.0	54.0
90th %ile Term Code	MaxR	MaxR	Coord	Coord	Coord	MaxR	MaxR	Coord	Coord	Coord
70th %ile Green (s)	28.0	28.0	54.0	54.0	54.0	28.0	28.0	54.0	54.0	54.0
70th %ile Term Code	MaxR	MaxR	Coord	Coord	Coord	MaxR	MaxR	Coord	Coord	Coord
50th %ile Green (s)	28.0	28.0	54.0	54.0	54.0	28.0	28.0	54.0	54.0	54.0
50th %ile Term Code	MaxR	MaxR	Coord	Coord	Coord	MaxR	MaxR	Coord	Coord	Coord
30th %ile Green (s)	28.0	28.0	54.0	54.0	54.0	28.0	28.0	54.0	54.0	54.0
30th %ile Term Code	MaxR	MaxR	Coord	Coord	Coord	MaxR	MaxR	Coord	Coord	Coord
10th %ile Green (s)	28.0	28.0	54.0	54.0	54.0	28.0	28.0	54.0	54.0	54.0
10th %ile Term Code	MaxR	MaxR	Coord	Coord	Coord	MaxR	MaxR	Coord	Coord	Coord

Intersection Summary

Cycle Length: 90

Actuated Cycle Length: 90

Offset: 44 (49%), Referenced to phase 2:NBTL and 6:SEL, Start of Green

Control Type: Pretimed

! Phase conflict between lane groups.



Lane Group	EBL	EBR	NBL2	NBT	SBT	SBR2	SEL	SER	SER2
Lane Group Flow (vph)	483	759	127	2448	641	411	866	849	83
v/c Ratio	0.88	1.49	0.90	1.27	1.23dr	0.82	0.90	0.94	0.09
Control Delay	48.7	255.2	23.1	136.0	25.7	33.0	30.6	37.2	7.9
Queue Delay	0.0	0.0	0.0	0.0	0.0	0.0	0.0	0.0	0.0
Total Delay	48.7	255.2	23.1	136.0	25.7	33.0	30.6	37.2	7.9
Queue Length 50th (m)	82.7	~191.0	3.4	~320.1	43.4	49.7	126.0	136.9	5.9
Queue Length 95th (m)	#139.9	#262.2	m#26.0	m#231.4	64.9	#107.5	#219.8	#235.8	11.9
Internal Link Dist (m)	45.3			76.4	289.3		128.6		
Turn Bay Length (m)			40.0						
Base Capacity (vph)	550	511	141	1930	908	504	960	902	949
Starvation Cap Reductn	0	0	0	0	0	0	0	0	0
Spillback Cap Reductn	0	0	0	0	0	0	0	0	0
Storage Cap Reductn	0	0	0	0	0	0	0	0	0
Reduced v/c Ratio	0.88	1.49	0.90	1.27	0.71	0.82	0.90	0.94	0.09

Intersection Summary

~ Volume exceeds capacity, queue is theoretically infinite.

Queue shown is maximum after two cycles.

95th percentile volume exceeds capacity, queue may be longer.

Queue shown is maximum after two cycles.

m Volume for 95th percentile queue is metered by upstream signal.

dr Defacto Right Lane. Recode with 1 though lane as a right lane.



Lane Group	EBL	EBR	NBL2	NBL	NBT	SBT	SBR	SBR2	SEL	SER	SER2
Enter Blocked Intersection	No	No	No	No	No	No	No	No	No	No	No
Lane Alignment	Left	Right	Left	Left	Left	Left	Right	Right	Left	Right	Right
Median Width(m)	3.6				10.0	3.6			8.0		
Link Offset(m)	0.0				0.0	0.0			0.0		
Crosswalk Width(m)	4.8				4.8	4.8			4.8		
Two way Left Turn Lane											
Headway Factor	1.00	1.00	1.00	1.00	1.00	1.14	1.14	1.14	1.00	1.00	1.00
Turning Speed (k/h)	25	15	25	25			15	15	25	15	15
Intersection Summary											



Movement	EBL	EBR	NBL2	NBL	NBT	SBT	SBR	SBR2	SEL	SER	SER2
Lane Configurations											
Volume (vph)	444	698	130	840	1399	0	212	756	76	1501	76
Pedestrians											
Ped Button											
Pedestrian Timing (s)											
Free Right		No					No	No		No	No
Ideal Flow	1900	1900	1900	1900	1900	1900	1900	1900	1900	1900	1900
Lost Time (s)	4.0	4.0	4.0	4.0	4.0	4.0	4.0	4.0	4.0	4.0	4.0
Minimum Green (s)	4.0	4.0	4.0	4.0	4.0	4.0	4.0	4.0	4.0	4.0	4.0
Refr Cycle Length (s)	120	120	120	120	120	120	120	120	120	120	120
Volume Combined (vph)	444	698	0	0	2369	464	0	504	576	1001	76
Lane Utilization Factor	1.00	1.00	1.00	1.00	0.95	0.95	1.00	1.00	1.00	1.00	1.00
Turning Factor (vph)	0.95	0.85	0.95	0.95	0.98	0.85	0.85	0.85	0.86	0.85	0.85
Saturated Flow (vph)	1805	1615	0	0	5315	3075	0	1615	1642	1615	1615
Ped Intf Time (s)	0.0	0.0	0.0	0.0	0.0	0.0	0.0	0.0	0.0	0.0	0.0
Pedestrian Frequency (%)	0.00				0.00	0.00			0.00		
Protected Option Allowed	No				No	No			No		
Reference Time (s)		51.9					0.0	37.4		74.4	5.6
Adj Reference Time (s)		55.9					0.0	41.4		78.4	9.6
Permitted Option											
Adj Saturation A (vph)	120		0	0	177	1537			109		
Reference Time A (s)	442.8		0.0	0.0	657.0	18.1			631.9		
Adj Saturation B (vph)	NA		NA	NA	NA	NA			NA		
Reference Time B (s)	NA		NA	NA	NA	NA			NA		
Reference Time (s)					657.0	18.1					
Adj Reference Time (s)					661.0	22.1					
Split Option											
Ref Time Combined (s)	29.5		0.0	0.0	53.5	18.1			42.1		
Ref Time Seperate (s)	29.5		4.3	55.8	46.4	0.0			5.6		
Reference Time (s)	29.5		55.8	55.8	55.8	18.1			42.1		
Adj Reference Time (s)	33.5		59.8	59.8	59.8	22.1			46.1		
Summary	EB		NB SB		SE		Combined				
Protected Option (s)	NA		NA		NA						
Permitted Option (s)	Err		661.0		Err						
Split Option (s)	33.5		82.0		46.1						
Minimum (s)	33.5		82.0		46.1		161.6				
Right Turns	EBR	SBR2	SER	SER2							
Adj Reference Time (s)	55.9	41.4	78.4	9.6							
Cross Thru Ref Time (s)	22.1	0.0	82.0	0.0							
Oncoming Left Ref Time (s)	0.0	59.8	0.0	82.0							
Combined (s)	156.3	101.3	160.3	91.6							

Intersection Summary

Intersection Capacity Utilization 134.7% ICU Level of Service H
 Reference Times and Phasing Options do not represent an optimized timing plan.



Lane Group	NBL2	NBT
Cycle Length (s)	90	90
Actual Green	54	54
Eff. Green	54	54
Opp. Eff. Green	54	54
Lanes	1	2
Opp. Lanes	1	1
Adj. LT Flow	127	14
Prop Left Turns	1.00	0.01
Prop LT Opp.	0.00	0.00
Adj. Opp. Flow	849	849
Total Lost Time	4.0	4.0
LTC	3.17	0.35
Volc	22.34	22.34
Rpo	1.00	1.00
gf	0.00	31.64
qro	0.40	0.40
gq	31.50	31.50
gu	22.50	22.36
n		
PTHo		
EL1	3.00	3.37
PL	1.00	0.01
fmin	0.07	0.04
fm		0.99
EL2		
Gdiff		
fLT	0.14	0.95



Approach	EB	NB	SB	SE
Crosswalk Length (m)	4.40	8.63	7.12	7.05
Crosswalk Width (m)	1.20	1.20	1.20	1.20
Total Number of Lanes Crossed	4	6	5	5
Number of Right-Turn Islands	0	0	0	0
Type of Control	None	None	None	None
Corresponding Signal Phase	6	4	2	4
Effective Walk Time (s)	0.0	0.0	0.0	0.0
Right Corner Size A (m)	2.74	2.74	2.74	2.74
Right Corner Size B (m)	2.74	2.74	2.74	2.74
Right Corner Curb Radius (m)	0.00	0.00	0.00	0.00
Right Corner Total Area (sq.m)	7.51	7.51	7.51	7.51
Ped. Left-Right Flow Rate (p/h)	0	0	0	0
Ped. Right-Left Flow Rate (p/h)	0	0	0	0
Ped. R. Sidewalk Flow Rate (p/h)	0	0	0	0
Veh. Perm. L. Flow in Walk (v/h)	0	0	0	0
Veh. Perm. R. Flow in Walk (v/h)	0	0	0	0
Veh. RTOR Flow in Walk (v/h)	0	0	0	0
85th percentile speed (km/h)	50	50	50	50
Right Corner Area per Ped (sq.m)	0.0	0.0	0.0	0.0
Right Corner Quality of Service	-	-	-	-
Ped. Circulation Area (sq.m)	0.0	0.0	0.0	0.0
Crosswalk Circulation Code	-	-	-	-
Pedestrian Delay (s/p)	45.0	45.0	45.0	45.0
Pedestrian Compliance Code	Poor	Poor	Poor	Poor
Pedestrian Crosswalk Score	2.57	3.30	2.94	3.02
Pedestrian Crosswalk LOS	C	C	C	C



Approach	EB	NB	SB	SE
Bicycle Flow Rate (bike/h)	0	0	0	0
Total Flow Rate (veh/h)	1242	2575	1052	1798
Effct. Green for Bike (s)	28.0	54.0	28.0	54.0
Cross Street Width (m)	28.30	23.36	23.12	14.45
Through Lanes Number	1	2	2	1
Through Lane Width (m)	3.60	3.60	2.70	3.60
Bicycle Lane Width (m)	0.00	0.00	0.00	0.00
Striped Parking Lane Width (m)	0.00	0.00	0.00	0.00
Paved Shoulder Width (m)	0.00	0.00	0.00	0.00
Curb Is Present?	No	No	No	No
On Street Parking?	No	No	No	No
Bicycle Lane Capacity (bike/h)	622	1200	622	1200
Bicycle Delay (s/bike)	21.4	7.2	21.4	7.2
Bicycle Compliance	Fair	Good	Fair	Good
Bicycle LOS Score	5.07	4.90	4.26	5.29
Bicycle LOS	E	E	D	E



Lane Group	WBL	WBR	NBT	NBR	SBL	SBT
Lane Configurations		↗↗	↑↑↑	↘	↘	↑↑↑
Traffic Volume (vph)	0	1053	1400	26	770	1543
Future Volume (vph)	0	1053	1400	26	770	1543
Ideal Flow (vphpl)	1900	1900	1900	1900	1900	1900
Storage Length (m)	0.0	0.0		0.0	50.0	
Storage Lanes	0	2		1	1	
Taper Length (m)	7.5				30.0	
Lane Util. Factor	1.00	0.88	0.91	1.00	1.00	0.91
Fr _t		0.850		0.850		
Flt Protected					0.950	
Satd. Flow (prot)	0	2787	5085	1583	1770	5085
Flt Permitted					0.142	
Satd. Flow (perm)	0	2787	5085	1583	265	5085
Right Turn on Red		Yes		Yes		
Satd. Flow (RTOR)		120		28		
Link Speed (k/h)	50		50			50
Link Distance (m)	222.2		572.3			100.4
Travel Time (s)	16.0		41.2			7.2
Peak Hour Factor	0.92	0.92	0.92	0.92	0.92	0.92
Adj. Flow (vph)	0	1145	1522	28	837	1677
Shared Lane Traffic (%)						
Lane Group Flow (vph)	0	1145	1522	28	837	1677
Enter Blocked Intersection	No	No	No	No	No	No
Lane Alignment	Left	Right	Left	Right	Left	Left
Median Width(m)	0.0		7.0			10.0
Link Offset(m)	0.0		0.0			0.0
Crosswalk Width(m)	4.8		4.8			4.8
Two way Left Turn Lane						
Headway Factor	1.00	1.00	1.00	1.00	1.00	1.00
Turning Speed (k/h)	25	15		15	25	
Turn Type		Perm	NA	Perm	Perm	NA
Protected Phases			2			6
Permitted Phases		8		2	6	
Minimum Split (s)		20.0	20.0	20.0	20.0	20.0
Total Split (s)		20.0	70.0	70.0	70.0	70.0
Total Split (%)		22.2%	77.8%	77.8%	77.8%	77.8%
Maximum Green (s)		16.0	66.0	66.0	66.0	66.0
Yellow Time (s)		3.5	3.5	3.5	3.5	3.5
All-Red Time (s)		0.5	0.5	0.5	0.5	0.5
Lost Time Adjust (s)		0.0	0.0	0.0	0.0	0.0
Total Lost Time (s)		4.0	4.0	4.0	4.0	4.0
Lead/Lag						
Lead-Lag Optimize?						
Walk Time (s)		5.0	5.0	5.0	5.0	5.0
Flash Dont Walk (s)		11.0	11.0	11.0	11.0	11.0
Pedestrian Calls (#/hr)		0	0	0	0	0
Act Effct Green (s)		16.0	66.0	66.0	66.0	66.0
Actuated g/C Ratio		0.18	0.73	0.73	0.73	0.73
v/c Ratio		1.93	0.41	0.02	4.31	0.45



Lane Group	WBL	WBR	NBT	NBR	SBL	SBT
Control Delay		446.5	4.3	0.9	1504.0	4.4
Queue Delay		4.9	0.0	0.0	0.0	1.7
Total Delay		451.4	4.3	0.9	1504.0	6.2
LOS		F	A	A	F	A
Approach Delay	451.4		4.3			504.8
Approach LOS	F		A			F
Stops (vph)		662	441	2	718	532
Fuel Used(l)		399	91	1	915	32
CO Emissions (g/hr)		7420	1686	27	17012	593
NOx Emissions (g/hr)		1432	325	5	3283	115
VOC Emissions (g/hr)		1711	389	6	3924	137
Dilemma Vehicles (#)		0	0	0	0	0
Queue Length 50th (m)		~175.7	29.6	0.0	~260.0	31.8
Queue Length 95th (m)		#220.6	27.4	m0.2	m#249.2	m28.6
Internal Link Dist (m)	198.2		548.3			76.4
Turn Bay Length (m)					50.0	
Base Capacity (vph)		594	3729	1168	194	3729
Starvation Cap Reductn		0	0	0	0	1805
Spillback Cap Reductn		250	50	0	0	0
Storage Cap Reductn		0	0	0	0	0
Reduced v/c Ratio		3.33	0.41	0.02	4.31	0.87

Intersection Summary

Area Type: Other
 Cycle Length: 90
 Actuated Cycle Length: 90
 Offset: 56 (62%), Referenced to phase 2:NBT and 6:SBTL, Start of Green
 Natural Cycle: 40
 Control Type: Pretimed
 Maximum v/c Ratio: 4.31
 Intersection Signal Delay: 344.2 Intersection LOS: F
 Intersection Capacity Utilization 76.4% ICU Level of Service D
 Analysis Period (min) 15
 ~ Volume exceeds capacity, queue is theoretically infinite.
 Queue shown is maximum after two cycles.
 # 95th percentile volume exceeds capacity, queue may be longer.
 Queue shown is maximum after two cycles.
 m Volume for 95th percentile queue is metered by upstream signal.

Splits and Phases: 2: AV. SAN MARTIN & Ca. Confraternidad

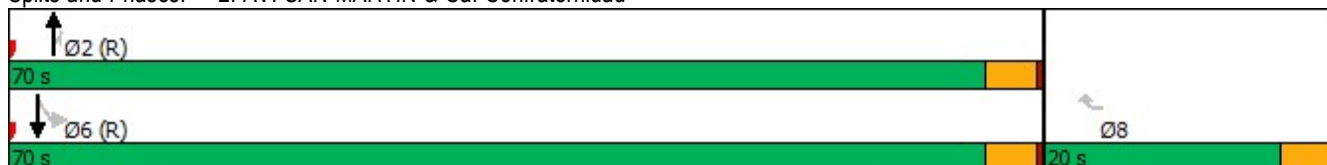



Lane Group	WBL	WBR	NBT	NBR	SBL	SBT
Lane Configurations		↑↑	↑↑↑	↑	↑	↑↑↑
Ideal Flow (vphpl)	1900	1900	1900	1900	1900	1900
Lane Width (m)	3.6	3.6	3.6	3.6	3.6	3.6
Grade (%)	0%		0%			0%
Storage Length (m)	0.0	0.0		0.0	50.0	
Storage Lanes	0	2		1	1	
Taper Length (m)	7.5				30.0	
Lane Util. Factor	1.00	0.88	0.91	1.00	1.00	0.91
Ped Bike Factor						
Fr _t		0.850		0.850		
Fl _t Protected					0.950	
Satd. Flow (prot)	0	2787	5085	1583	1770	5085
Fl _t Permitted					0.142	
Satd. Flow (perm)	0	2787	5085	1583	265	5085
Right Turn on Red		Yes		Yes		
Satd. Flow (RTOR)		120		28		
Link Speed (k/h)	50		50			50
Link Distance (m)	222.2		572.3			100.4
Travel Time (s)	16.0		41.2			7.2

Intersection Summary

Area Type: Other



Lane Group	WBL	WBR	NBT	NBR	SBL	SBT
Traffic Volume (vph)	0	1053	1400	26	770	1543
Future Volume (vph)	0	1053	1400	26	770	1543
Confl. Peds. (#/hr)						
Confl. Bikes (#/hr)						
Peak Hour Factor	0.92	0.92	0.92	0.92	0.92	0.92
Growth Factor	100%	100%	100%	100%	100%	100%
Heavy Vehicles (%)	2%	2%	2%	2%	2%	2%
Bus Blockages (#/hr)	0	0	0	0	0	0
Parking (#/hr)						
Mid-Block Traffic (%)	0%		0%			0%
Adj. Flow (vph)	0	1145	1522	28	837	1677
Shared Lane Traffic (%)						
Lane Group Flow (vph)	0	1145	1522	28	837	1677
Intersection Summary						



	↖	↑	↗	↘	↓
Lane Group	WBR	NBT	NBR	SBL	SBT
Lane Configurations	↖↖	↑↑↑	↗	↘	↑↑↑
Future Volume (vph)	1053	1400	26	770	1543
Turn Type	Perm	NA	Perm	Perm	NA
Protected Phases		2			6
Permitted Phases	8		2	6	
Detector Phase	8	2	2	6	6
Switch Phase					
Minimum Initial (s)	4.0	4.0	4.0	4.0	4.0
Minimum Split (s)	20.0	20.0	20.0	20.0	20.0
Total Split (s)	20.0	70.0	70.0	70.0	70.0
Total Split (%)	22.2%	77.8%	77.8%	77.8%	77.8%
Yellow Time (s)	3.5	3.5	3.5	3.5	3.5
All-Red Time (s)	0.5	0.5	0.5	0.5	0.5
Lost Time Adjust (s)	0.0	0.0	0.0	0.0	0.0
Total Lost Time (s)	4.0	4.0	4.0	4.0	4.0
Lead/Lag					
Lead-Lag Optimize?					
Recall Mode	Max	Max	Max	Max	Max
Act Effct Green (s)	16.0	66.0	66.0	66.0	66.0
Actuated g/C Ratio	0.18	0.73	0.73	0.73	0.73
v/c Ratio	1.93	0.41	0.02	4.31	0.45
Control Delay	446.5	4.3	0.9	1504.0	4.4
Queue Delay	4.9	0.0	0.0	0.0	1.7
Total Delay	451.4	4.3	0.9	1504.0	6.2
LOS	F	A	A	F	A
Approach Delay		4.3			504.8
Approach LOS		A			F

Intersection Summary

Cycle Length: 90
 Actuated Cycle Length: 90
 Offset: 56 (62%), Reference d to phase 2:NBT and 6:SBTL, Start o Green
 Natural Cycle: 40
 Control Type: Pretimed
 Maximum v/c Ratio: 4.31
 Intersection Signal Delay: 344.2
 Intersection LOS: F
 Intersection Capacity Utilization 76.4%
 ICU Level of Service D
 Analysis Period (min) 15

Splits and Phases: 2: AV. SAN MARTIN & Ca. Confraternidad

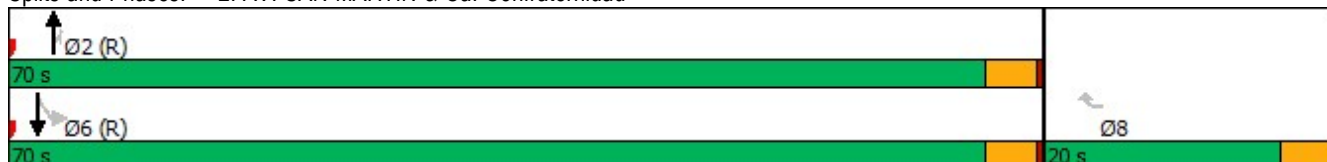



Lane Group	WBR	NBT	NBR	SBL	SBT
Protected Phases		2			6
Permitted Phases	8		2	6	
Minimum Initial (s)	4.0	4.0	4.0	4.0	4.0
Minimum Split (s)	20.0	20.0	20.0	20.0	20.0
Total Split (s)	20.0	70.0	70.0	70.0	70.0
Total Split (%)	22.2%	77.8%	77.8%	77.8%	77.8%
Maximum Green (s)	16.0	66.0	66.0	66.0	66.0
Yellow Time (s)	3.5	3.5	3.5	3.5	3.5
All-Red Time (s)	0.5	0.5	0.5	0.5	0.5
Lead/Lag					
Lead-Lag Optimize?					
Vehicle Extension (s)	3.0	3.0	3.0	3.0	3.0
Minimum Gap (s)	3.0	3.0	3.0	3.0	3.0
Time Before Reduce (s)	0.0	0.0	0.0	0.0	0.0
Time To Reduce (s)	0.0	0.0	0.0	0.0	0.0
Recall Mode	Max	Max	Max	Max	Max
Walk Time (s)	5.0	5.0	5.0	5.0	5.0
Flash Dont Walk (s)	11.0	11.0	11.0	11.0	11.0
Pedestrian Calls (#/hr)	0	0	0	0	0
90th %ile Green (s)	16.0	66.0	66.0	66.0	66.0
90th %ile Term Code	MaxR	Coord	Coord	Coord	Coord
70th %ile Green (s)	16.0	66.0	66.0	66.0	66.0
70th %ile Term Code	MaxR	Coord	Coord	Coord	Coord
50th %ile Green (s)	16.0	66.0	66.0	66.0	66.0
50th %ile Term Code	MaxR	Coord	Coord	Coord	Coord
30th %ile Green (s)	16.0	66.0	66.0	66.0	66.0
30th %ile Term Code	MaxR	Coord	Coord	Coord	Coord
10th %ile Green (s)	16.0	66.0	66.0	66.0	66.0
10th %ile Term Code	MaxR	Coord	Coord	Coord	Coord

Intersection Summary

Cycle Length: 90

Actuated Cycle Length: 90

Offset: 56 (62%), Referenced to phase 2:NBT and 6:SBTL, Start of Green

Control Type: Pretimed



Lane Group	WBR	NBT	NBR	SBL	SBT
Lane Group Flow (vph)	1145	1522	28	837	1677
v/c Ratio	1.93	0.41	0.02	4.31	0.45
Control Delay	446.5	4.3	0.9	1504.0	4.4
Queue Delay	4.9	0.0	0.0	0.0	1.7
Total Delay	451.4	4.3	0.9	1504.0	6.2
Queue Length 50th (m)	~175.7	29.6	0.0	~260.0	31.8
Queue Length 95th (m)	#220.6	27.4	m0.2	m#249.2	m28.6
Internal Link Dist (m)		548.3			76.4
Turn Bay Length (m)				50.0	
Base Capacity (vph)	594	3729	1168	194	3729
Starvation Cap Reductn	0	0	0	0	1805
Spillback Cap Reductn	250	50	0	0	0
Storage Cap Reductn	0	0	0	0	0
Reduced v/c Ratio	3.33	0.41	0.02	4.31	0.87

Intersection Summary

~ Volume exceeds capacity, queue is theoretic ally infi nite.

Queue shown is maximum after two cycles.

95th percentile volume exceeds capacity, queue may be longer.

Queue shown is maximum after two cycles.

m Volume for 95th percentile queue is metered by upstream signal.



Lane Group	WBL	WBR	NBT	NBR	SBL	SBT
Enter Blocked Intersection	No	No	No	No	No	No
Lane Alignment	Left	Right	Left	Right	Left	Left
Median Width(m)	0.0		7.0			10.0
Link Offset(m)	0.0		0.0			0.0
Crosswalk Width(m)	4.8		4.8			4.8
Two way Left Turn Lane						
Headway Factor	1.00	1.00	1.00	1.00	1.00	1.00
Turning Speed (k/h)	25	15		15	25	
Intersection Summary						



Movement	WBL	WBR	NBT	NBR	SBL	SBT
Lane Configurations		↗↗	↑↑↑	↘	↘	↑↑↑
Volume (vph)	0	1053	1400	26	770	1543
Pedestrians						
Ped Button						
Pedestrian Timing (s)						
Free Right		No		No		
Ideal Flow	1900	1900	1900	1900	1900	1900
Lost Time (s)	4.0	4.0	4.0	4.0	4.0	4.0
Minimum Green (s)	4.0	4.0	4.0	4.0	4.0	4.0
Refr Cycle Length (s)	120	120	120	120	120	120
Volume Combined (vph)	0	1053	1400	26	770	1543
Lane Utilization Factor	1.00	0.89	0.91	1.00	1.00	0.91
Turning Factor (vph)	0.95	0.85	1.00	0.85	0.95	1.00
Saturated Flow (vph)	0	2859	5176	1615	1805	5176
Ped Intf Time (s)	0.0	0.0	0.0	0.0	0.0	0.0
Pedestrian Frequency (%)	0.00		0.00			0.00
Protected Option Allowed	No		Yes			Yes
Reference Time (s)		44.2	32.5	1.9	51.2	35.8
Adj Reference Time (s)		48.2	36.5	8.0	55.2	39.8
Permitted Option						
Adj Saturation A (vph)	0		1725		120	1725
Reference Time A (s)	0.0		32.5		767.9	35.8
Adj Saturation B (vph)	NA		NA		NA	NA
Reference Time B (s)	NA		NA		NA	NA
Reference Time (s)			32.5			767.9
Adj Reference Time (s)			36.5			771.9
Split Option						
Ref Time Combined (s)	0.0		32.5		51.2	35.8
Ref Time Seperate (s)	0.0		32.5		51.2	35.8
Reference Time (s)	0.0		32.5		51.2	51.2
Adj Reference Time (s)	0.0		36.5		55.2	55.2
Summary	WB		NB SB		Combined	
Protected Option (s)	NA		91.7			
Permitted Option (s)	Err		771.9			
Split Option (s)	0.0		91.7			
Minimum (s)	0.0		91.7		91.7	
Right Turns	WBR	NBR				
Adj Reference Time (s)	48.2	8.0				
Cross Thru Ref Time (s)	36.5	0.0				
Oncoming Left Ref Time (s)	0.0	55.2				
Combined (s)	84.7	63.2				

Intersection Summary

Intersection Capacity Utilization 76.4% ICU Level of Service D
 Reference Times and Phasing Options do not represent an optimized timing plan.



Lane Group	SBL
Cycle Length (s)	90
Actual Green	66
Eff. Green	66
Opp. Eff. Green	66
Lanes	1
Opp. Lanes	3
Adj. LT Flow	837
Prop Left Turns	1.00
Prop LT Opp.	
Adj. Opp. Flow	1522
Total Lost Time	4.0
LTC	20.93
Volc	13.94
Rpo	1.00
gf	0.00
qro	0.27
gq	6.77
gu	59.23
n	
PTHo	
EL1	6.31
PL	1.00
fmin	0.06
fm	
EL2	
Gdiff	
fLT	0.14



Approach	WB	NB	SB
Crosswalk Length (m)	3.82	10.93	8.53
Crosswalk Width (m)	1.20	1.20	1.20
Total Number of Lanes Crossed	3	8	6
Number of Right-Turn Islands	0	0	0
Type of Control	None	None	None
Corresponding Signal Phase	2	6	0
Effective Walk Time (s)	0.0	0.0	0.0
Right Corner Size A (m)	2.74	2.74	2.74
Right Corner Size B (m)	2.74	2.74	2.74
Right Corner Curb Radius (m)	0.00	0.00	0.00
Right Corner Total Area (sq.m)	7.51	7.51	7.51
Ped. Left-Right Flow Rate (p/h)	0	0	0
Ped. Right-Left Flow Rate (p/h)	0	0	0
Ped. R. Sidewalk Flow Rate (p/h)	0	0	0
Veh. Perm. L. Flow in Walk (v/h)	0	0	0
Veh. Perm. R. Flow in Walk (v/h)	0	0	0
Veh. RTOR Flow in Walk (v/h)	0	0	0
85th percentile speed (km/h)	50	50	50
Right Corner Area per Ped (sq.m)	0.0	0.0	0.0
Right Corner Quality of Service	-	-	-
Ped. Circulation Area (sq.m)	0.0	0.0	0.0
Crosswalk Circulation Code	-	-	-
Pedestrian Delay (s/p)	45.0	45.0	45.0
Pedestrian Compliance Code	Poor	Poor	Poor
Pedestrian Crosswalk Score	2.63	3.14	3.33
Pedestrian Crosswalk LOS	C	C	C



Approach	WB	NB	SB
Bicycle Flow Rate (bike/h)	0	0	0
Total Flow Rate (veh/h)	1145	1550	2514
Effct. Green for Bike (s)	0.0	66.0	66.0
Cross Street Width (m)	28.00	12.52	35.85
Through Lanes Number	0	3	3
Through Lane Width (m)	3.60	3.60	3.60
Bicycle Lane Width (m)	0.00	0.00	0.00
Striped Parking Lane Width (m)	0.00	0.00	0.00
Paved Shoulder Width (m)	0.00	0.00	0.00
Curb Is Present?	No	No	No
On Street Parking?	No	No	No
Bicycle Lane Capacity (bike/h)	0	1467	1467
Bicycle Delay (s/bike)	0.0	3.2	3.2
Bicycle Compliance		Good	Good
Bicycle LOS Score	0.00	3.08	4.78
Bicycle LOS		C	E

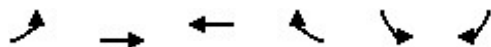

Lane Group	EBL	EBT	WBT	WBR	SBL	SBR
Lane Configurations			↑	↑↑↑↑		↑↑↑↑
Traffic Volume (vph)	0	0	285	1401	0	1543
Future Volume (vph)	0	0	285	1401	0	1543
Ideal Flow (vphpl)	1900	1900	1900	1900	1900	1900
Lane Util. Factor	1.00	1.00	1.00	0.76	1.00	0.64
Fr _t				0.850		0.850
Flt Protected						
Satd. Flow (prot)	0	0	1863	3610	0	4053
Flt Permitted						
Satd. Flow (perm)	0	0	1863	3610	0	4053
Right Turn on Red				Yes		Yes
Satd. Flow (RTOR)				1523		573
Link Speed (k/h)		50	50		50	
Link Distance (m)		89.5	73.5		572.3	
Travel Time (s)		6.4	5.3		41.2	
Peak Hour Factor	0.92	0.92	0.92	0.92	0.92	0.92
Adj. Flow (vph)	0	0	310	1523	0	1677
Shared Lane Traffic (%)						
Lane Group Flow (vph)	0	0	310	1523	0	1677
Enter Blocked Intersection	No	No	No	No	No	No
Lane Alignment	Left	Left	Left	Right	Left	Right
Median Width(m)		0.0	0.0		10.0	
Link Offset(m)		0.0	0.0		0.0	
Crosswalk Width(m)		4.8	4.8		4.8	
Two way Left Turn Lane						
Headway Factor	1.00	1.00	1.00	1.00	1.00	1.00
Turning Speed (k/h)	25			15	25	15
Turn Type			NA	Prot		Perm
Protected Phases			8	8		
Permitted Phases						6
Minimum Split (s)			20.0	20.0		60.0
Total Split (s)			27.0	27.0		63.0
Total Split (%)			30.0%	30.0%		70.0%
Maximum Green (s)			23.0	23.0		59.0
Yellow Time (s)			3.5	3.5		3.5
All-Red Time (s)			0.5	0.5		0.5
Lost Time Adjust (s)			0.0	0.0		0.0
Total Lost Time (s)			4.0	4.0		4.0
Lead/Lag						
Lead-Lag Optimize?						
Walk Time (s)			5.0	5.0		5.0
Flash Dont Walk (s)			11.0	11.0		11.0
Pedestrian Calls (#/hr)			0	0		0
Act Effect Green (s)			23.0	23.0		59.0
Actuated g/C Ratio			0.26	0.26		0.66
v/c Ratio			0.65	0.74		0.59
Control Delay			29.2	12.8		10.3
Queue Delay			6.6	2.0		0.0
Total Delay			35.8	14.8		10.3

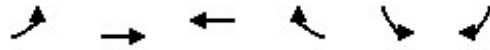

Lane Group	EBL	EBT	WBT	WBR	SBL	SBR
LOS			D	B		B
Approach Delay			18.4		10.3	
Approach LOS			B		B	
Stops (vph)			262	983		755
Fuel Used(l)			14	46		113
CO Emissions (g/hr)			265	849		2103
NOx Emissions (g/hr)			51	164		406
VOC Emissions (g/hr)			61	196		485
Dilemma Vehicles (#)			0	0		0
Queue Length 50th (m)			55.3	61.5		45.1
Queue Length 95th (m)			82.0	80.0		70.2
Internal Link Dist (m)		65.5	49.5		548.3	
Turn Bay Length (m)						
Base Capacity (vph)			476	2056		2854
Starvation Cap Reductn			119	366		0
Spillback Cap Reductn			0	0		0
Storage Cap Reductn			0	0		0
Reduced v/c Ratio			0.87	0.90		0.59

Intersection Summary

Area Type:	Other
Cycle Length:	90
Actuated Cycle Length:	90
Offset:	53 (59%), Referenc ed to phase 2: and 6: SBR, Sta t of Green
Natural Cycle:	80
Control Type:	Pretimed
Maximum v/c Ratio:	0.74
Intersection Signal Delay:	14.5
Intersection LOS:	B
Intersection Capacity Utilization	48.7%
ICU Level of Service	A
Analysis Period (min)	15

Splits and Phases: 3: AV. SAN MARTIN



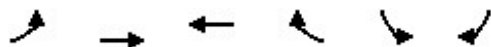

Lane Group	EBL	EBT	WBT	WBR	SBL	SBR
Lane Configurations			↑	↑↑↑↑		↑↑↑↑
Ideal Flow (vphpl)	1900	1900	1900	1900	1900	1900
Lane Width (m)	3.6	3.6	3.6	3.6	3.6	3.6
Grade (%)		0%	0%		0%	
Storage Length (m)	0.0			0.0	0.0	0.0
Storage Lanes	0			3	0	4
Taper Length (m)	7.5				7.5	
Lane Util. Factor	1.00	1.00	1.00	0.76	1.00	0.64
Ped Bike Factor						
Fr _t				0.850		0.850
Flt Protected						
Satd. Flow (prot)	0	0	1863	3610	0	4053
Flt Permitted						
Satd. Flow (perm)	0	0	1863	3610	0	4053
Right Turn on Red				Yes		Yes
Satd. Flow (RTOR)				1523		573
Link Speed (k/h)		50	50		50	
Link Distance (m)		89.5	73.5		572.3	
Travel Time (s)		6.4	5.3		41.2	

Intersection Summary

Area Type: Other



Lane Group	EBL	EBT	WBT	WBR	SBL	SBR
Traffic Volume (vph)	0	0	285	1401	0	1543
Future Volume (vph)	0	0	285	1401	0	1543
Confl. Peds. (#/hr)						
Confl. Bikes (#/hr)						
Peak Hour Factor	0.92	0.92	0.92	0.92	0.92	0.92
Growth Factor	100%	100%	100%	100%	100%	100%
Heavy Vehicles (%)	2%	2%	2%	2%	2%	2%
Bus Blockages (#/hr)	0	0	0	0	0	0
Parking (#/hr)						
Mid-Block Traffic (%)		0%	0%		0%	
Adj. Flow (vph)	0	0	310	1523	0	1677
Shared Lane Traffic (%)						
Lane Group Flow (vph)	0	0	310	1523	0	1677
Intersection Summary						



Lane Group	WBT	WBR	SBR
Lane Configurations	↑	↑↑↑↑	↑↑↑↑
Traffic Volume (vph)	285	1401	1543
Future Volume (vph)	285	1401	1543
Turn Type	NA	Prot	Perm
Protected Phases	8	8	
Permitted Phases			6
Detector Phase	8	8	6
Switch Phase			
Minimum Initial (s)	4.0	4.0	4.0
Minimum Split (s)	20.0	20.0	60.0
Total Split (s)	27.0	27.0	63.0
Total Split (%)	30.0%	30.0%	70.0%
Yellow Time (s)	3.5	3.5	3.5
All-Red Time (s)	0.5	0.5	0.5
Lost Time Adjust (s)	0.0	0.0	0.0
Total Lost Time (s)	4.0	4.0	4.0
Lead/Lag			
Lead-Lag Optimize?			
Recall Mode	Max	Max	Max
Act Effct Green (s)	23.0	23.0	59.0
Actuated g/C Ratio	0.26	0.26	0.66
v/c Ratio	0.65	0.74	0.59
Control Delay	29.2	12.8	10.3
Queue Delay	6.6	2.0	0.0
Total Delay	35.8	14.8	10.3
LOS	D	B	B
Approach Delay	18.4		
Approach LOS	B		

Intersection Summary

Cycle Length: 90	
Actuated Cycle Length: 90	
Offset: 53 (59%), Reference d to phase 2: and 6: SBR, Start of Green	
Natural Cycle: 80	
Control Type: Pretimed	
Maximum v/c Ratio: 0.74	
Intersection Signal Delay: 14.5	Intersection LOS: B
Intersection Capacity Utilization 48.7%	ICU Level of Service A
Analysis Period (min) 15	

Splits and Phases: 3: AV. SAN MARTIN





Lane Group	WBT	WBR	SBR
Protected Phases	8	8	
Permitted Phases			6
Minimum Initial (s)	4.0	4.0	4.0
Minimum Split (s)	20.0	20.0	60.0
Total Split (s)	27.0	27.0	63.0
Total Split (%)	30.0%	30.0%	70.0%
Maximum Green (s)	23.0	23.0	59.0
Yellow Time (s)	3.5	3.5	3.5
All-Red Time (s)	0.5	0.5	0.5
Lead/Lag			
Lead-Lag Optimize?			
Vehicle Extension (s)	3.0	3.0	3.0
Minimum Gap (s)	3.0	3.0	3.0
Time Before Reduce (s)	0.0	0.0	0.0
Time To Reduce (s)	0.0	0.0	0.0
Recall Mode	Max	Max	Max
Walk Time (s)	5.0	5.0	5.0
Flash Dont Walk (s)	11.0	11.0	11.0
Pedestrian Calls (#/hr)	0	0	0
90th %ile Green (s)	23.0	23.0	59.0
90th %ile Term Code	MaxR	MaxR	Coord
70th %ile Green (s)	23.0	23.0	59.0
70th %ile Term Code	MaxR	MaxR	Coord
50th %ile Green (s)	23.0	23.0	59.0
50th %ile Term Code	MaxR	MaxR	Coord
30th %ile Green (s)	23.0	23.0	59.0
30th %ile Term Code	MaxR	MaxR	Coord
10th %ile Green (s)	23.0	23.0	59.0
10th %ile Term Code	MaxR	MaxR	Coord

Intersection Summary

Cycle Length: 90

Actuated Cycle Length: 90

Offset: 53 (59%), Referenced to phase 2: and 6:SBR, Start of Green

Control Type: Pretimed



Lane Group	WBT	WBR	SBR
Lane Group Flow (vph)	310	1523	1677
v/c Ratio	0.65	0.74	0.59
Control Delay	29.2	12.8	10.3
Queue Delay	6.6	2.0	0.0
Total Delay	35.8	14.8	10.3
Queue Length 50th (m)	55.3	61.5	45.1
Queue Length 95th (m)	82.0	80.0	70.2
Internal Link Dist (m)	49.5		
Turn Bay Length (m)			
Base Capacity (vph)	476	2056	2854
Starvation Cap Reductn	119	366	0
Spillback Cap Reductn	0	0	0
Storage Cap Reductn	0	0	0
Reduced v/c Ratio	0.87	0.90	0.59
Intersection Summary			

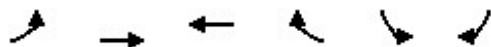

Lane Group	EBL	EBT	WBT	WBR	SBL	SBR
Enter Blocked Intersection	No	No	No	No	No	No
Lane Alignment	Left	Left	Left	Right	Left	Right
Median Width(m)		0.0	0.0		10.0	
Link Offset(m)		0.0	0.0		0.0	
Crosswalk Width(m)		4.8	4.8		4.8	
Two way Left Turn Lane						
Headway Factor	1.00	1.00	1.00	1.00	1.00	1.00
Turning Speed (k/h)	25			15	25	15
Intersection Summary						

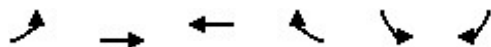

Movement	EBL	EBT	WBT	WBR	SBL	SBR
Lane Configurations			↑	↑↑↑		↑↑↑↑
Volume (vph)	0	0	285	1401	0	1543
Pedestrians						
Ped Button						
Pedestrian Timing (s)						
Free Right				No		No
Ideal Flow	1900	1900	1900	1900	1900	1900
Lost Time (s)	4.0	4.0	4.0	4.0	4.0	4.0
Minimum Green (s)	4.0	4.0	4.0	4.0	4.0	4.0
Refr Cycle Length (s)	120	120	120	120	120	120
Volume Combined (vph)	0	0	285	1401	0	1543
Lane Utilization Factor	1.00	1.00	1.00	0.89	1.00	0.89
Turning Factor (vph)	0.95	1.00	1.00	0.85	0.95	0.85
Saturated Flow (vph)	0	0	1900	4288	0	5717
Ped Intf Time (s)	0.0	0.0	0.0	0.0	0.0	0.0
Pedestrian Frequency (%)		0.00	0.00		0.00	
Protected Option Allowed		Yes	Yes		No	
Reference Time (s)	0.0	0.0	18.0	39.2		32.4
Adj Reference Time (s)	0.0	0.0	22.0	43.2		36.4
Permitted Option						
Adj Saturation A (vph)	0	0	1900		0	
Reference Time A (s)	0.0	0.0	18.0		0.0	
Adj Saturation B (vph)	NA	NA	1900		NA	
Reference Time B (s)	NA	NA	18.0		NA	
Reference Time (s)		0.0	18.0			
Adj Reference Time (s)		8.0	22.0			
Split Option						
Ref Time Combined (s)	0.0	0.0	18.0		0.0	
Ref Time Seperate (s)	0.0	0.0	18.0		0.0	
Reference Time (s)	0.0	0.0	18.0		0.0	
Adj Reference Time (s)	0.0	0.0	22.0		0.0	
Summary	EB WB		SB		Combined	
Protected Option (s)	22.0		NA			
Permitted Option (s)	22.0		Err			
Split Option (s)	22.0		0.0			
Minimum (s)	22.0		0.0		22.0	
Right Turns	WBR	SBR				
Adj Reference Time (s)	43.2	36.4				
Cross Thru Ref Time (s)	0.0	22.0				
Oncoming Left Ref Time (s)	0.0	0.0				
Combined (s)	43.2	58.4				

Intersection Summary

Intersection Capacity Utilization 48.7% ICU Level of Service A
Reference Times and Phasing Options do not represent an optimized timing plan.



Approach	EB	WB	SB
Crosswalk Length (m)	6.26	6.02	11.84
Crosswalk Width (m)	1.20	1.20	1.20
Total Number of Lanes Crossed	4	4	8
Number of Right-Turn Islands	0	0	0
Type of Control	None	None	None
Corresponding Signal Phase	0	0	8
Effective Walk Time (s)	0.0	0.0	0.0
Right Corner Size A (m)	2.74	2.74	2.74
Right Corner Size B (m)	2.74	2.74	2.74
Right Corner Curb Radius (m)	0.00	0.00	0.00
Right Corner Total Area (sq.m)	7.51	7.51	7.51
Ped. Left-Right Flow Rate (p/h)	0	0	0
Ped. Right-Left Flow Rate (p/h)	0	0	0
Ped. R. Sidewalk Flow Rate (p/h)	0	0	0
Veh. Perm. L. Flow in Walk (v/h)	0	0	0
Veh. Perm. R. Flow in Walk (v/h)	0	0	0
Veh. RTOR Flow in Walk (v/h)	0	0	0
85th percentile speed (km/h)	50	50	50
Right Corner Area per Ped (sq.m)	0.0	0.0	0.0
Right Corner Quality of Service	-	-	-
Ped. Circulation Area (sq.m)	0.0	0.0	0.0
Crosswalk Circulation Code	-	-	-
Pedestrian Delay (s/p)	45.0	45.0	45.0
Pedestrian Compliance Code	Poor	Poor	Poor
Pedestrian Crosswalk Score	2.64	2.60	3.14
Pedestrian Crosswalk LOS	C	C	C



Approach	EB	WB	SB
Bicycle Flow Rate (bike/h)	0	0	0
Total Flow Rate (veh/h)	0	1833	1677
Effct. Green for Bike (s)	0.0	23.0	0.0
Cross Street Width (m)	19.76	38.85	20.54
Through Lanes Number	0	1	0
Through Lane Width (m)	3.60	3.60	3.60
Bicycle Lane Width (m)	0.00	0.00	0.00
Striped Parking Lane Width (m)	0.00	0.00	0.00
Paved Shoulder Width (m)	0.00	0.00	0.00
Curb Is Present?	No	No	No
On Street Parking?	No	No	No
Bicycle Lane Capacity (bike/h)	0	511	0
Bicycle Delay (s/bike)	0.0	24.9	0.0
Bicycle Compliance		Fair	
Bicycle LOS Score	0.00	6.57	0.00
Bicycle LOS		F	



Lane Group	EBL	EBR	NBL	NBT	SBT	SBR
Lane Configurations						
Traffic Volume (vph)	0	63	0	0	1460	83
Future Volume (vph)	0	63	0	0	1460	83
Ideal Flow (vphpl)	1900	1900	1900	1900	1900	1900
Lane Util. Factor	1.00	1.00	1.00	1.00	0.91	1.00
Fr _t		0.865				0.850
Flt Protected						
Satd. Flow (prot)	0	1611	0	0	5085	1583
Flt Permitted						
Satd. Flow (perm)	0	1611	0	0	5085	1583
Link Speed (k/h)	50			50	50	
Link Distance (m)	231.0			52.8	89.5	
Travel Time (s)	16.6			3.8	6.4	
Peak Hour Factor	0.92	0.92	0.92	0.92	0.92	0.92
Adj. Flow (vph)	0	68	0	0	1587	90
Shared Lane Traffic (%)						
Lane Group Flow (vph)	0	68	0	0	1587	90
Enter Blocked Intersection	No	No	No	No	No	No
Lane Alignment	Left	Right	Left	Left	Left	Right
Median Width(m)	0.0			0.0	0.0	
Link Offset(m)	0.0			0.0	0.0	
Crosswalk Width(m)	4.8			4.8	4.8	
Two way Left Turn Lane						
Headway Factor	1.00	1.00	1.00	1.00	1.00	1.00
Turning Speed (k/h)	25	15	25			15
Sign Control	Stop			Free	Free	

Intersection Summary

Area Type:	Other
Control Type:	Unsignalized
Intersection Capacity Utilization	38.8%
ICU Level of Service	A
Analysis Period (min)	15



4.

10/11/2021



Lane Group	EBL	EBR	NBL	NBT	SBT	SBR
Lane Configurations						
Ideal Flow (vphpl)	1900	1900	1900	1900	1900	1900
Lane Width (m)	3.6	3.6	3.6	3.6	3.6	3.6
Grade (%)	0%			0%	0%	
Storage Length (m)	0.0	0.0	0.0			0.0
Storage Lanes	0	1	0			1
Taper Length (m)	7.5		7.5			
Lane Util. Factor	1.00	1.00	1.00	1.00	0.91	1.00
Ped Bike Factor						
Fr _t		0.865				0.850
Flt Protected						
Satd. Flow (prot)	0	1611	0	0	5085	1583
Flt Permitted						
Satd. Flow (perm)	0	1611	0	0	5085	1583
Link Speed (k/h)	50			50	50	
Link Distance (m)	231.0			52.8	89.5	
Travel Time (s)	16.6			3.8	6.4	

Intersection Summary

Area Type: Other



Lane Group	EBL	EBR	NBL	NBT	SBT	SBR
Traffic Volume (vph)	0	63	0	0	1460	83
Future Volume (vph)	0	63	0	0	1460	83
Confl. Peds. (#/hr)						
Confl. Bikes (#/hr)						
Peak Hour Factor	0.92	0.92	0.92	0.92	0.92	0.92
Growth Factor	100%	100%	100%	100%	100%	100%
Heavy Vehicles (%)	2%	2%	2%	2%	2%	2%
Bus Blockages (#/hr)	0	0	0	0	0	0
Parking (#/hr)						
Mid-Block Traffic (%)	0%			0%	0%	
Adj. Flow (vph)	0	68	0	0	1587	90
Shared Lane Traffic (%)						
Lane Group Flow (vph)	0	68	0	0	1587	90
Intersection Summary						



Lane Group	EBL	EBR	NBL	NBT	SBT	SBR
Enter Blocked Intersection	No	No	No	No	No	No
Lane Alignment	Left	Right	Left	Left	Left	Right
Median Width(m)	0.0			0.0	0.0	
Link Offset(m)	0.0			0.0	0.0	
Crosswalk Width(m)	4.8			4.8	4.8	
Two way Left Turn Lane						
Headway Factor	1.00	1.00	1.00	1.00	1.00	1.00
Turning Speed (k/h)	25	15	25			15
Intersection Summary						



Movement	EBL	EBR	NBL	NBT	SBT	SBR
Lane Configurations		↗			↑↑↑	↗
Volume (vph)	0	63	0	0	1460	83
Pedestrians						
Ped Button						
Pedestrian Timing (s)						
Free Right		No				No
Ideal Flow	1900	1900	1900	1900	1900	1900
Lost Time (s)	4.0	4.0	4.0	4.0	4.0	4.0
Minimum Green (s)	4.0	4.0	4.0	4.0	4.0	4.0
Refr Cycle Length (s)	120	120	120	120	120	120
Volume Combined (vph)	0	63	0	0	1460	83
Lane Utilization Factor	1.00	1.00	1.00	1.00	0.91	1.00
Turning Factor (vph)	0.95	0.85	0.95	1.00	1.00	0.85
Saturated Flow (vph)	0	1615	0	0	5176	1615
Ped Intf Time (s)	0.0	0.0	0.0	0.0	0.0	0.0
Pedestrian Frequency (%)	0.00			0.00	0.00	
Protected Option Allowed	No			Yes	Yes	
Reference Time (s)		4.7	0.0	0.0	33.9	6.2
Adj Reference Time (s)		8.7	0.0	0.0	37.9	10.2
Permitted Option						
Adj Saturation A (vph)	0		0	0	1725	
Reference Time A (s)	0.0		0.0	0.0	33.9	
Adj Saturation B (vph)	NA		NA	NA	5176	
Reference Time B (s)	NA		NA	NA	33.9	
Reference Time (s)				0.0	33.9	
Adj Reference Time (s)				8.0	37.9	
Split Option						
Ref Time Combined (s)	0.0		0.0	0.0	33.9	
Ref Time Seperate (s)	0.0		0.0	0.0	33.9	
Reference Time (s)	0.0		0.0	0.0	33.9	
Adj Reference Time (s)	0.0		0.0	0.0	37.9	
Summary	EB		NB SB		Combined	
Protected Option (s)	NA		37.9			
Permitted Option (s)	Err		37.9			
Split Option (s)	0.0		37.9			
Minimum (s)	0.0		37.9		37.9	
Right Turns	EBR	SBR				
Adj Reference Time (s)	8.7	10.2				
Cross Thru Ref Time (s)	37.9	0.0				
Oncoming Left Ref Time (s)	0.0	0.0				
Combined (s)	46.5	10.2				
Intersection Summary						
Intersection Capacity Utilization			38.8%	ICU Level of Service		A
Reference Times and Phasing Options do not represent an optimized timing plan.						



Intersection

Int Delay, s/veh 0.9

Movement	EBL	EBR	NBL	NBT	SBT	SBR
Lane Configurations		↑			↑↑↑	↑
Traffic Vol, veh/h	0	63	0	0	1460	83
Future Vol, veh/h	0	63	0	0	1460	83
Conflicting Peds, #/hr	0	0	0	0	0	0
Sign Control	Stop	Stop	Free	Free	Free	Free
RT Channelized	-	None	-	None	-	None
Storage Length	-	0	-	-	-	0
Veh in Median Storage, #	0	-	-	16974	0	-
Grade, %	0	-	-	0	0	-
Peak Hour Factor	92	92	92	92	92	92
Heavy Vehicles, %	2	2	2	2	2	2
Mvmt Flow	0	68	0	0	1587	90

Major/Minor

	Minor2	Major2
Conflicting Flow All	- 794	- 0
Stage 1	- -	- -
Stage 2	- -	- -
Critical Hdwy	- 7.14	- -
Critical Hdwy Stg 1	- -	- -
Critical Hdwy Stg 2	- -	- -
Follow-up Hdwy	- 3.92	- -
Pot Cap-1 Maneuver	0 284	- -
Stage 1	0 -	- -
Stage 2	0 -	- -
Platoon blocked, %		- -
Mov Cap-1 Maneuver	- 284	- -
Mov Cap-2 Maneuver	- -	- -
Stage 1	- -	- -
Stage 2	- -	- -

Approach

HCM Control Delay, s 21.7 0

HCM LOS C

Minor Lane/Major Mvmt

	EBLn1	SBT	SBR
Capacity (veh/h)	284	-	-
HCM Lane V/C Ratio	0.241	-	-
HCM Control Delay (s)	21.7	-	-
HCM Lane LOS	C	-	-
HCM 95th %tile Q(veh)	0.9	-	-



Approach

Approach Direction	NB
Median Present?	No
Approach Delay(s)	1.97105649599218E20
Level of Service	F

Crosswalk

Length (ft)	132
Lanes Crossed	3
Veh Vol Crossed	1460
Ped Vol Crossed	0
Yield Rate(%)	0
Ped Platooning	No
Critical Headway (s)	113.00
Prob of Delayed X-ing	1.00
Prob of Blocked Lane	1.00
Delay for adq Gap	1.97105649599218E20
Avg Ped Delay (s)	1.97105649599218E20

Approach

Approach Direction	SB
Median Present?	No
Approach Delay(s)	5.31363028612362E25
Level of Service	F

Crosswalk

Length (ft)	169
Lanes Crossed	3
Veh Vol Crossed	1460
Ped Vol Crossed	0
Yield Rate(%)	0
Ped Platooning	No
Critical Headway (s)	143.83
Prob of Delayed X-ing	1.00
Prob of Blocked Lane	1.00
Delay for adq Gap	5.31363028612362E25
Avg Ped Delay (s)	5.31363028612362E25



Lane Group	WBL	WBR	NBT	NBR	SBL	SBT
Lane Configurations				↗	↖↗	↗
Traffic Volume (vph)	0	0	0	49	1445	77
Future Volume (vph)	0	0	0	49	1445	77
Ideal Flow (vphpl)	1900	1900	1900	1900	1900	1900
Lane Util. Factor	1.00	1.00	1.00	1.00	0.97	1.00
Fr _t				0.865		
Flt Protected					0.950	
Satd. Flow (prot)	0	0	0	1611	3433	1863
Flt Permitted					0.950	
Satd. Flow (perm)	0	0	0	1611	3433	1863
Link Speed (k/h)	50		50			50
Link Distance (m)	150.3		188.1			52.8
Travel Time (s)	10.8		13.5			3.8
Peak Hour Factor	0.92	0.92	0.92	0.92	0.92	0.92
Adj. Flow (vph)	0	0	0	53	1571	84
Shared Lane Traffic (%)						
Lane Group Flow (vph)	0	0	0	53	1571	84
Enter Blocked Intersection	No	No	No	No	No	No
Lane Alignment	Left	Right	Left	Right	Left	Left
Median Width(m)	0.0		0.0			7.2
Link Offset(m)	0.0		0.0			0.0
Crosswalk Width(m)	4.8		4.8			4.8
Two way Left Turn Lane						
Headway Factor	1.00	1.00	1.00	1.00	1.00	1.00
Turning Speed (k/h)	25	15		15	25	
Sign Control	Free		Stop			Stop

Intersection Summary

Area Type:	Other
Control Type:	Unsignalized
Intersection Capacity Utilization	51.2%
ICU Level of Service	A
Analysis Period (min)	15



Lane Group	WBL	WBR	NBT	NBR	SBL	SBT
Lane Configurations						
Ideal Flow (vphpl)	1900	1900	1900	1900	1900	1900
Lane Width (m)	3.6	3.6	3.6	3.6	3.6	3.6
Grade (%)	0%		0%			0%
Storage Length (m)	0.0	0.0		0.0	0.0	
Storage Lanes	0	0		1	2	
Taper Length (m)	7.5				7.5	
Lane Util. Factor	1.00	1.00	1.00	1.00	0.97	1.00
Ped Bike Factor						
Fr _t				0.865		
Flt Protected					0.950	
Satd. Flow (prot)	0	0	0	1611	3433	1863
Flt Permitted					0.950	
Satd. Flow (perm)	0	0	0	1611	3433	1863
Link Speed (k/h)	50		50			50
Link Distance (m)	150.3		188.1			52.8
Travel Time (s)	10.8		13.5			3.8

Intersection Summary

Area Type: Other



Lane Group	WBL	WBR	NBT	NBR	SBL	SBT
Traffic Volume (vph)	0	0	0	49	1445	77
Future Volume (vph)	0	0	0	49	1445	77
Confl. Peds. (#/hr)						
Confl. Bikes (#/hr)						
Peak Hour Factor	0.92	0.92	0.92	0.92	0.92	0.92
Growth Factor	100%	100%	100%	100%	100%	100%
Heavy Vehicles (%)	2%	2%	2%	2%	2%	2%
Bus Blockages (#/hr)	0	0	0	0	0	0
Parking (#/hr)						
Mid-Block Traffic (%)	0%		0%			0%
Adj. Flow (vph)	0	0	0	53	1571	84
Shared Lane Traffic (%)						
Lane Group Flow (vph)	0	0	0	53	1571	84
Intersection Summary						



Lane Group	WBL	WBR	NBT	NBR	SBL	SBT
Enter Blocked Intersection	No	No	No	No	No	No
Lane Alignment	Left	Right	Left	Right	Left	Left
Median Width(m)	0.0		0.0			7.2
Link Offset(m)	0.0		0.0			0.0
Crosswalk Width(m)	4.8		4.8			4.8
Two way Left Turn Lane						
Headway Factor	1.00	1.00	1.00	1.00	1.00	1.00
Turning Speed (k/h)	25	15		15	25	
Intersection Summary						



Movement	WBL	WBR	NBT	NBR	SBL	SBT
Lane Configurations				↗	↘↗	↗
Volume (vph)	0	0	0	49	1445	77
Pedestrians						
Ped Button						
Pedestrian Timing (s)						
Free Right		No		No		
Ideal Flow	1900	1900	1900	1900	1900	1900
Lost Time (s)	4.0	4.0	4.0	4.0	4.0	4.0
Minimum Green (s)	4.0	4.0	4.0	4.0	4.0	4.0
Refr Cycle Length (s)	120	120	120	120	120	120
Volume Combined (vph)	0	0	0	49	1445	77
Lane Utilization Factor	1.00	1.00	1.00	1.00	0.97	1.00
Turning Factor (vph)	0.95	0.85	1.00	0.85	0.95	1.00
Saturated Flow (vph)	0	0	0	1615	3505	1900
Ped Intf Time (s)	0.0	0.0	0.0	0.0	0.0	0.0
Pedestrian Frequency (%)	0.00		0.00			0.00
Protected Option Allowed	No		Yes			Yes
Reference Time (s)		0.0	0.0	3.6	49.5	4.9
Adj Reference Time (s)		0.0	0.0	8.0	53.5	8.9
Permitted Option						
Adj Saturation A (vph)	0		0		117	1900
Reference Time A (s)	0.0		0.0		742.0	4.9
Adj Saturation B (vph)	NA		0		0	1900
Reference Time B (s)	NA		0.0		57.5	4.9
Reference Time (s)			0.0			57.5
Adj Reference Time (s)			8.0			61.5
Split Option						
Ref Time Combined (s)	0.0		0.0		49.5	4.9
Ref Time Seperate (s)	0.0		0.0		49.5	4.9
Reference Time (s)	0.0		0.0		49.5	49.5
Adj Reference Time (s)	0.0		0.0		53.5	53.5
Summary	WB		NB SB		Combined	
Protected Option (s)	NA		53.5			
Permitted Option (s)	Err		61.5			
Split Option (s)	0.0		53.5			
Minimum (s)	0.0		53.5		53.5	
Right Turns	NBR					
Adj Reference Time (s)	8.0					
Cross Thru Ref Time (s)	0.0					
Oncoming Left Ref Time (s)	53.5					
Combined (s)	61.5					
Intersection Summary						
Intersection Capacity Utilization		51.2%	ICU Level of Service			A
Reference Times and Phasing Options do not represent an optimized timing plan.						



Approach

Approach Direction	WB
Median Present?	No
Approach Delay(s)	0.0
Level of Service	A

Crosswalk

Length (ft)	165
Lanes Crossed	0
Veh Vol Crossed	0
Ped Vol Crossed	0
Yield Rate(%)	0
Ped Platooning	No
Critical Headway (s)	140.50
Prob of Delayed X-ing	0.00
Prob of Blocked Lane	NAN
Delay for adq Gap	0.00
Avg Ped Delay (s)	0.00



0. ACCESO TERMINAL

10/11/2021



Lane Group	EBL	EBT	EBR	WBL	WBT	WBR	NBL	NBT	NBR	SBL	SBT	SBR
Lane Configurations		↑↑↑									↑	
Traffic Volume (vph)	60	1004	345	0	0	0	0	0	0	91	100	0
Future Volume (vph)	60	1004	345	0	0	0	0	0	0	91	100	0
Ideal Flow (vphpl)	1900	1900	1900	1900	1900	1900	1900	1900	1900	1900	1900	1900
Lane Util. Factor	0.91	0.91	0.91	1.00	1.00	1.00	1.00	1.00	1.00	1.00	1.00	1.00
Fr _t		0.963										
Fl _t Protected		0.998									0.977	
Satd. Flow (prot)	0	4887	0	0	0	0	0	0	0	0	1820	0
Fl _t Permitted		0.998									0.977	
Satd. Flow (perm)	0	4887	0	0	0	0	0	0	0	0	1820	0
Link Speed (k/h)		50			50			50			50	
Link Distance (m)		150.3			170.0			0.0			94.5	
Travel Time (s)		10.8			12.2			0.0			6.8	
Peak Hour Factor	0.92	0.92	0.92	0.92	0.92	0.92	0.92	0.92	0.92	0.92	0.92	0.92
Adj. Flow (vph)	65	1091	375	0	0	0	0	0	0	99	109	0
Shared Lane Traffic (%)												
Lane Group Flow (vph)	0	1531	0	0	0	0	0	0	0	0	208	0
Enter Blocked Intersection	No	No	No	No	No	No	No	No	No	No	No	No
Lane Alignment	Left	Left	Right	Left	Left	Right	Left	Left	Right	Left	Left	Right
Median Width(m)		0.0			0.0			0.0			5.0	
Link Offset(m)		0.0			0.0			0.0			0.0	
Crosswalk Width(m)		4.8			4.8			4.8			4.8	
Two way Left Turn Lane												
Headway Factor	1.00	1.00	1.00	1.00	1.00	1.00	1.00	1.00	1.00	1.00	1.00	1.00
Turning Speed (k/h)	25		15	25		15	25		15	25		15
Sign Control		Free			Free			Stop			Stop	

Intersection Summary

Area Type: Other

Control Type: Unsignalized

Intersection Capacity Utilization 45.3%

ICU Level of Service A

Analysis Period (min) 15



0. ACCESO TERMINAL

10/11/2021



Lane Group	EBL	EBT	EBR	WBL	WBT	WBR	NBL	NBT	NBR	SBL	SBT	SBR
Lane Configurations		↕↕↕									↕	
Ideal Flow (vphpl)	1900	1900	1900	1900	1900	1900	1900	1900	1900	1900	1900	1900
Lane Width (m)	3.6	3.6	3.6	3.6	3.6	3.6	3.6	3.6	3.6	3.6	3.6	3.6
Grade (%)		0%			0%			0%			0%	
Storage Length (m)	0.0		0.0	0.0		0.0	0.0		0.0	0.0		0.0
Storage Lanes	0		0	0		0	0		0	0		0
Taper Length (m)	7.5			7.5			7.5			7.5		
Lane Util. Factor	0.91	0.91	0.91	1.00	1.00	1.00	1.00	1.00	1.00	1.00	1.00	1.00
Ped Bike Factor												
Frt		0.963										
Flt Protected		0.998									0.977	
Satd. Flow (prot)	0	4887	0	0	0	0	0	0	0	0	1820	0
Flt Permitted		0.998									0.977	
Satd. Flow (perm)	0	4887	0	0	0	0	0	0	0	0	1820	0
Link Speed (k/h)		50			50			50			50	
Link Distance (m)		150.3			170.0			0.0			94.5	
Travel Time (s)		10.8			12.2			0.0			6.8	

Intersection Summary

Area Type: Other



0. ACCESO TERMINAL

10/11/2021



Lane Group	EBL	EBT	EBR	WBL	WBT	WBR	NBL	NBT	NBR	SBL	SBT	SBR
Traffic Volume (vph)	60	1004	345	0	0	0	0	0	0	91	100	0
Future Volume (vph)	60	1004	345	0	0	0	0	0	0	91	100	0
Confl. Peds. (#/hr)												
Confl. Bikes (#/hr)												
Peak Hour Factor	0.92	0.92	0.92	0.92	0.92	0.92	0.92	0.92	0.92	0.92	0.92	0.92
Growth Factor	100%	100%	100%	100%	100%	100%	100%	100%	100%	100%	100%	100%
Heavy Vehicles (%)	2%	2%	2%	2%	2%	2%	2%	2%	2%	2%	2%	2%
Bus Blockages (#/hr)	0	0	0	0	0	0	0	0	0	0	0	0
Parking (#/hr)												
Mid-Block Traffic (%)		0%			0%			0%			0%	
Adj. Flow (vph)	65	1091	375	0	0	0	0	0	0	99	109	0
Shared Lane Traffic (%)												
Lane Group Flow (vph)	0	1531	0	0	0	0	0	0	0	0	208	0

Intersection Summary



9. ACCESO TERMINAL

10/11/2021



Lane Group	EBL	EBT	EBR	WBL	WBT	WBR	NBL	NBT	NBR	SBL	SBT	SBR
Enter Blocked Intersection	No	No	No	No	No	No	No	No	No	No	No	No
Lane Alignment	Left	Left	Right	Left	Left	Right	Left	Left	Right	Left	Left	Right
Median Width(m)		0.0			0.0			0.0			5.0	
Link Offset(m)		0.0			0.0			0.0			0.0	
Crosswalk Width(m)		4.8			4.8			4.8			4.8	
Two way Left Turn Lane												
Headway Factor	1.00	1.00	1.00	1.00	1.00	1.00	1.00	1.00	1.00	1.00	1.00	1.00
Turning Speed (k/h)	25		15	25		15	25		15	25		15

Intersection Summary



0. ACCESO TERMINAL

10/11/2021



Movement	EBL	EBT	EBR	WBL	WBT	WBR	NBL	NBT	NBR	SBL	SBT	SBR
Lane Configurations		↕↕↕									↕	
Volume (vph)	60	1004	345	0	0	0	0	0	0	91	100	0
Pedestrians												
Ped Button												
Pedestrian Timing (s)												
Free Right			No			No			No			No
Ideal Flow	1900	1900	1900	1900	1900	1900	1900	1900	1900	1900	1900	1900
Lost Time (s)	4.0	4.0	4.0	4.0	4.0	4.0	4.0	4.0	4.0	4.0	4.0	4.0
Minimum Green (s)	4.0	4.0	4.0	4.0	4.0	4.0	4.0	4.0	4.0	4.0	4.0	4.0
Refr Cycle Length (s)	120	120	120	120	120	120	120	120	120	120	120	120
Volume Combined (vph)	0	1409	0	0	0	0	0	0	0	0	191	0
Lane Utilization Factor	1.00	0.91	1.00	1.00	1.00	1.00	1.00	1.00	1.00	1.00	1.00	1.00
Turning Factor (vph)	0.95	0.96	0.85	0.95	1.00	0.85	0.95	1.00	0.85	0.95	0.98	0.85
Saturated Flow (vph)	0	4975	0	0	0	0	0	0	0	0	1855	0
Ped Intf Time (s)	0.0	0.0	0.0	0.0	0.0	0.0	0.0	0.0	0.0	0.0	0.0	0.0
Pedestrian Frequency (%)		0.00			0.00			0.00			0.00	
Protected Option Allowed		No			No			No			No	
Reference Time (s)			0.0			0.0			0.0			0.0
Adj Reference Time (s)			0.0			0.0			0.0			0.0
Permitted Option												
Adj Saturation A (vph)	0	421		0	0		0	0		0	221	
Reference Time A (s)	0.0	88.3		0.0	0.0		0.0	0.0		0.0	103.7	
Adj Saturation B (vph)	0	3318		NA	NA		0	0		0	0	
Reference Time B (s)	12.0	36.7		NA	NA		0.0	0.0		14.0	20.4	
Reference Time (s)		36.7			0.0			0.0			20.4	
Adj Reference Time (s)		40.7			8.0			8.0			24.4	
Split Option												
Ref Time Combined (s)	0.0	34.0		0.0	0.0		0.0	0.0		0.0	12.4	
Ref Time Seperate (s)	4.0	24.2		0.0	0.0		0.0	0.0		6.0	6.3	
Reference Time (s)	34.0	34.0		0.0	0.0		0.0	0.0		12.4	12.4	
Adj Reference Time (s)	38.0	38.0		0.0	0.0		0.0	0.0		16.4	16.4	
Summary	EB WB		NB SB	Combined								
Protected Option (s)	NA		NA									
Permitted Option (s)	40.7		24.4									
Split Option (s)	38.0		16.4									
Minimum (s)	38.0		16.4	54.3								

Right Turns	
Adj Reference Time (s)	
Cross Thru Ref Time (s)	
Oncoming Left Ref Time (s)	
Combined (s)	

Intersection Summary	
Intersection Capacity Utilization	45.3%
ICU Level of Service	A
Reference Times and Phasing Options do not represent an optimized timing plan.	



Intersection

Int Delay, s/veh 2

Movement	EBL	EBT	EBR	WBL	WBT	WBR	NBL	NBT	NBR	SBL	SBT	SBR
Lane Configurations		↑↑↑									↑	
Traffic Vol, veh/h	60	1004	345	0	0	0	0	0	0	91	100	0
Future Vol, veh/h	60	1004	345	0	0	0	0	0	0	91	100	0
Conflicting Peds, #/hr	0	0	0	0	0	0	0	0	0	0	0	0
Sign Control	Free	Free	Free	Free	Free	Free	Stop	Stop	Stop	Stop	Stop	Stop
RT Channelized	-	-	None	-	-	None	-	-	None	-	-	None
Storage Length	-	-	-	-	-	-	-	-	-	-	-	-
Veh in Median Storage, #	-	0	-	-	16979	-	-	16979	-	-	0	-
Grade, %	-	0	-	-	0	-	-	0	-	-	0	-
Peak Hour Factor	92	92	92	92	92	92	92	92	92	92	92	92
Heavy Vehicles, %	2	2	2	2	2	2	2	2	2	2	2	2
Mvmt Flow	65	1091	375	0	0	0	0	0	0	99	109	0

Major/Minor	Major1			Minor2		
Conflicting Flow All	0	0	0	566	1596	-
Stage 1	-	-	-	0	0	-
Stage 2	-	-	-	566	1596	-
Critical Hdwy	5.34	-	-	5.74	6.54	-
Critical Hdwy Stg 1	-	-	-	-	-	-
Critical Hdwy Stg 2	-	-	-	6.04	5.54	-
Follow-up Hdwy	3.12	-	-	3.82	4.02	-
Pot Cap-1 Maneuver	-	-	-	508	~ 106	0
Stage 1	-	-	-	-	-	0
Stage 2	-	-	-	485	165	0
Platoon blocked, %	-	-	-	-	-	-
Mov Cap-1 Maneuver	-	-	-	508	0	-
Mov Cap-2 Maneuver	-	-	-	508	0	-
Stage 1	-	-	-	-	0	-
Stage 2	-	-	-	485	0	-

Approach	EB	SB
HCM Control Delay, s		16.9
HCM LOS		C

Minor Lane/Major Mvmt	EBL	EBT	EBR	SBLn1
Capacity (veh/h)	-	-	-	508
HCM Lane V/C Ratio	-	-	-	0.409
HCM Control Delay (s)	-	-	-	16.9
HCM Lane LOS	-	-	-	C
HCM 95th %tile Q(veh)	-	-	-	2

Notes

~: Volume exceeds capacity \$: Delay exceeds 300s +: Computation Not Defined *: All major volume in platoon



Approach

Approach Direction	EB
Median Present?	No
Approach Delay(s)	219811376267264.0
Level of Service	F

Crosswalk

Length (ft)	133
Lanes Crossed	3
Veh Vol Crossed	1004
Ped Vol Crossed	0
Yield Rate(%)	0
Ped Platooning	No
Critical Headway (s)	113.83
Prob of Delayed X-ing	1.00
Prob of Blocked Lane	1.00
Delay for adq Gap	219811376267264.00
Avg Ped Delay (s)	219811376267264.00

Approach

Approach Direction	WB
Median Present?	No
Approach Delay(s)	9056978999443456.0
Level of Service	F

Crosswalk

Length (ft)	149
Lanes Crossed	3
Veh Vol Crossed	1004
Ped Vol Crossed	0
Yield Rate(%)	0
Ped Platooning	No
Critical Headway (s)	127.17
Prob of Delayed X-ing	1.00
Prob of Blocked Lane	1.00
Delay for adq Gap	9056978999443456.00
Avg Ped Delay (s)	9056978999443456.00



Lane Group	WBT	NBL	NBR	SBL	SBR2	NER
Lane Configurations	↑↑↑↑	↖	↗	↖	↗	↗↗↗
Traffic Volume (vph)	1117	124	98	121	245	1261
Future Volume (vph)	1117	124	98	121	245	1261
Ideal Flow (vphpl)	1900	1900	1900	1900	1900	1900
Lane Util. Factor	0.86	1.00	1.00	1.00	1.00	0.76
Fr _t			0.850		0.850	0.850
Flt Protected		0.950		0.950		
Satd. Flow (prot)	6408	1770	1583	1770	1583	3610
Flt Permitted		0.950		0.950		
Satd. Flow (perm)	6408	1770	1583	1770	1583	3610
Right Turn on Red			Yes		Yes	
Satd. Flow (RTOR)			24		24	
Link Speed (k/h)	50					
Link Distance (m)	536.6					
Travel Time (s)	38.6					
Peak Hour Factor	0.92	0.92	0.92	0.92	0.92	0.92
Adj. Flow (vph)	1214	135	107	132	266	1371
Shared Lane Traffic (%)						
Lane Group Flow (vph)	1214	135	107	132	266	1371
Enter Blocked Intersection	No	No	No	No	No	No
Lane Alignment	Left	Left	Right	Left	Right	Right
Median Width(m)	8.0					
Link Offset(m)	0.0					
Crosswalk Width(m)	4.8					
Two way Left Turn Lane						
Headway Factor	1.00	1.00	1.00	1.00	1.00	1.00
Turning Speed (k/h)		25	15	25	15	15
Turn Type	NA	Perm	Perm	Prot	Perm	Perm
Protected Phases				6!		
Permitted Phases	6!	8	8		4	2
Minimum Split (s)	20.0	20.0	20.0	20.0	20.0	20.0
Total Split (s)	19.0	26.0	26.0	19.0	26.0	19.0
Total Split (%)	42.2%	57.8%	57.8%	42.2%	57.8%	42.2%
Maximum Green (s)	15.0	22.0	22.0	15.0	22.0	15.0
Yellow Time (s)	3.5	3.5	3.5	3.5	3.5	3.5
All-Red Time (s)	0.5	0.5	0.5	0.5	0.5	0.5
Lost Time Adjust (s)	0.0	0.0	0.0	0.0	0.0	0.0
Total Lost Time (s)	4.0	4.0	4.0	4.0	4.0	4.0
Lead/Lag						
Lead-Lag Optimize?						
Walk Time (s)	5.0	5.0	5.0	5.0	5.0	5.0
Flash Dont Walk (s)	11.0	11.0	11.0	11.0	11.0	11.0
Pedestrian Calls (#/hr)	0	0	0	0	0	0
Act Effect Green (s)	15.0	22.0	22.0	15.0	22.0	15.0
Actuated g/C Ratio	0.33	0.49	0.49	0.33	0.49	0.33
v/c Ratio	0.57	0.16	0.14	0.22	0.34	1.14
Control Delay	13.4	7.0	5.7	12.1	7.9	92.6
Queue Delay	0.0	0.0	0.0	0.0	0.0	0.0
Total Delay	13.4	7.0	5.7	12.1	7.9	92.6



Lane Group	WBT	NBL	NBR	SBL	SBR2	NER
LOS	B	A	A	B	A	F
Approach Delay	13.4					
Approach LOS	B					
Stops (vph)	692	62	41	82	126	1036
Fuel Used(l)	84	3	2	5	9	133
CO Emissions (g/hr)	1561	64	46	95	160	2482
NOx Emissions (g/hr)	301	12	9	18	31	479
VOC Emissions (g/hr)	360	15	11	22	37	573
Dilemma Vehicles (#)	0	0	0	0	0	0
Queue Length 50th (m)	29.5	5.5	3.3	7.6	10.9	~61.5
Queue Length 95th (m)	m38.5	12.3	9.1	17.1	22.4	#89.8
Internal Link Dist (m)	512.6					
Turn Bay Length (m)						
Base Capacity (vph)	2136	865	786	590	786	1203
Starvation Cap Reductn	0	0	0	0	0	0
Spillback Cap Reductn	0	0	0	0	0	0
Storage Cap Reductn	0	0	0	0	0	0
Reduced v/c Ratio	0.57	0.16	0.14	0.22	0.34	1.14

Intersection Summary

Area Type: Other
 Cycle Length: 45
 Actuated Cycle Length: 45
 Offset: 0 (0%), Referenced to phase 2:NER and 6:WBSB, Start of Green
 Natural Cycle: 45
 Control Type: Pretimed
 Maximum v/c Ratio: 1.14
 Intersection Signal Delay: 46.0 Intersection LOS: D
 Intersection Capacity Utilization 52.2% ICU Level of Service A
 Analysis Period (min) 15
 ~ Volume exceeds capacity, queue is theoretically infinite.
 Queue shown is maximum after two cycles.
 # 95th percentile volume exceeds capacity, queue may be longer.
 Queue shown is maximum after two cycles.
 m Volume for 95th percentile queue is metered by upstream signal.
 ! Phase conflict between lane groups.

Splits and Phases: 7: AV. MICAELA BASTIDAS/Av. Mateo Pumacahua & AV. 28 DE JULIO

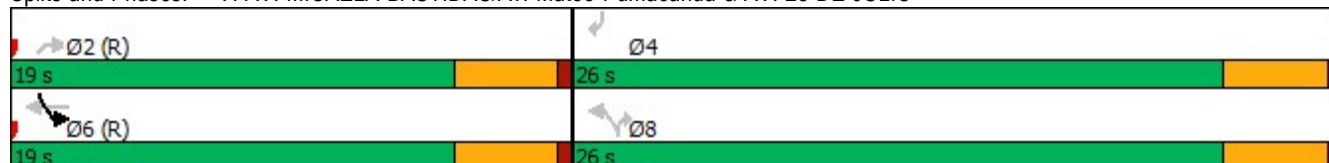



Lane Group	WBT	NBL	NBR	SBL	SBR2	NER
Lane Configurations	↑↑↑↑	↑	↑	↑	↑	↑↑↑↑
Ideal Flow (vphpl)	1900	1900	1900	1900	1900	1900
Lane Width (m)	3.6	3.6	3.6	3.6	3.6	3.6
Grade (%)	0%					
Storage Length (m)		0.0	0.0	0.0		0.0
Storage Lanes		1	1	1		3
Taper Length (m)		7.5		7.5		
Lane Util. Factor	0.86	1.00	1.00	1.00	1.00	0.76
Ped Bike Factor						
Frt			0.850		0.850	0.850
Flt Protected		0.950		0.950		
Satd. Flow (prot)	6408	1770	1583	1770	1583	3610
Flt Permitted		0.950		0.950		
Satd. Flow (perm)	6408	1770	1583	1770	1583	3610
Right Turn on Red			Yes		Yes	
Satd. Flow (RTOR)			24		24	
Link Speed (k/h)	50					
Link Distance (m)	536.6					
Travel Time (s)	38.6					

Intersection Summary

Area Type: Other



Lane Group	WBT	NBL	NBR	SBL	SBR2	NER
Traffic Volume (vph)	1117	124	98	121	245	1261
Future Volume (vph)	1117	124	98	121	245	1261
Confl. Peds. (#/hr)						
Confl. Bikes (#/hr)						
Peak Hour Factor	0.92	0.92	0.92	0.92	0.92	0.92
Growth Factor	100%	100%	100%	100%	100%	100%
Heavy Vehicles (%)	2%	2%	2%	2%	2%	2%
Bus Blockages (#/hr)	0	0	0	0	0	0
Parking (#/hr)						
Mid-Block Traffic (%)	0%					
Adj. Flow (vph)	1214	135	107	132	266	1371
Shared Lane Traffic (%)						
Lane Group Flow (vph)	1214	135	107	132	266	1371

Intersection Summary



Lane Group	WBT	NBL	NBR	SBL	SBR2	NER
Lane Configurations						
Future Volume (vph)	1117	124	98	121	245	1261
Turn Type	NA	Perm	Perm	Prot	Perm	Perm
Protected Phases				6!		
Permitted Phases	6!	8	8		4	2
Detector Phase	6	8	8	6	4	2
Switch Phase						
Minimum Initial (s)	4.0	4.0	4.0	4.0	4.0	4.0
Minimum Split (s)	20.0	20.0	20.0	20.0	20.0	20.0
Total Split (s)	19.0	26.0	26.0	19.0	26.0	19.0
Total Split (%)	42.2%	57.8%	57.8%	42.2%	57.8%	42.2%
Yellow Time (s)	3.5	3.5	3.5	3.5	3.5	3.5
All-Red Time (s)	0.5	0.5	0.5	0.5	0.5	0.5
Lost Time Adjust (s)	0.0	0.0	0.0	0.0	0.0	0.0
Total Lost Time (s)	4.0	4.0	4.0	4.0	4.0	4.0
Lead/Lag						
Lead-Lag Optimize?						
Recall Mode	Max	Max	Max	Max	Max	Max
Act Effct Green (s)	15.0	22.0	22.0	15.0	22.0	15.0
Actuated g/C Ratio	0.33	0.49	0.49	0.33	0.49	0.33
v/c Ratio	0.57	0.16	0.14	0.22	0.34	1.14
Control Delay	13.4	7.0	5.7	12.1	7.9	92.6
Queue Delay	0.0	0.0	0.0	0.0	0.0	0.0
Total Delay	13.4	7.0	5.7	12.1	7.9	92.6
LOS	B	A	A	B	A	F
Approach Delay	13.4					
Approach LOS	B					

Intersection Summary

Cycle Length: 45
 Actuated Cycle Length: 45
 Offset: 0 (0%), Referenced to phase 2:NER and 6:WBSB Start of Green
 Natural Cycle: 45
 Control Type: Pretimed
 Maximum v/c Ratio: 1.14
 Intersection Signal Delay: 46.0 Intersection LOS: D
 Intersection Capacity Utilization 52.2% ICU Level of Service A
 Analysis Period (min) 15
 ! Phase conflict between lane groups.

Splits and Phases: 7: AV. MICAELA BASTIDAS/Av. Mateo Pumacahua & AV. 28 DE JULIO

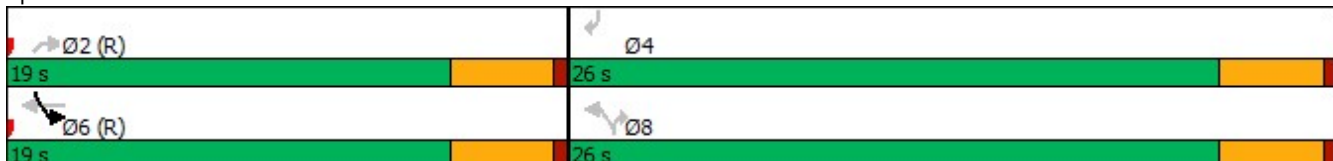



Lane Group	WBT	NBL	NBR	SBL	SBR2	NER
Protected Phases				6!		
Permitted Phases	6!	8	8		4	2
Minimum Initial (s)	4.0	4.0	4.0	4.0	4.0	4.0
Minimum Split (s)	20.0	20.0	20.0	20.0	20.0	20.0
Total Split (s)	19.0	26.0	26.0	19.0	26.0	19.0
Total Split (%)	42.2%	57.8%	57.8%	42.2%	57.8%	42.2%
Maximum Green (s)	15.0	22.0	22.0	15.0	22.0	15.0
Yellow Time (s)	3.5	3.5	3.5	3.5	3.5	3.5
All-Red Time (s)	0.5	0.5	0.5	0.5	0.5	0.5
Lead/Lag						
Lead-Lag Optimize?						
Vehicle Extension (s)	3.0	3.0	3.0	3.0	3.0	3.0
Minimum Gap (s)	3.0	3.0	3.0	3.0	3.0	3.0
Time Before Reduce (s)	0.0	0.0	0.0	0.0	0.0	0.0
Time To Reduce (s)	0.0	0.0	0.0	0.0	0.0	0.0
Recall Mode	Max	Max	Max	Max	Max	Max
Walk Time (s)	5.0	5.0	5.0	5.0	5.0	5.0
Flash Dont Walk (s)	11.0	11.0	11.0	11.0	11.0	11.0
Pedestrian Calls (#/hr)	0	0	0	0	0	0
90th %ile Green (s)	15.0	22.0	22.0	15.0	22.0	15.0
90th %ile Term Code	Coord	MaxR	MaxR	Coord	MaxR	Coord
70th %ile Green (s)	15.0	22.0	22.0	15.0	22.0	15.0
70th %ile Term Code	Coord	MaxR	MaxR	Coord	MaxR	Coord
50th %ile Green (s)	15.0	22.0	22.0	15.0	22.0	15.0
50th %ile Term Code	Coord	MaxR	MaxR	Coord	MaxR	Coord
30th %ile Green (s)	15.0	22.0	22.0	15.0	22.0	15.0
30th %ile Term Code	Coord	MaxR	MaxR	Coord	MaxR	Coord
10th %ile Green (s)	15.0	22.0	22.0	15.0	22.0	15.0
10th %ile Term Code	Coord	MaxR	MaxR	Coord	MaxR	Coord

Intersection Summary

Cycle Length: 45
 Actuated Cycle Length: 45
 Offset: 0 (0%), Referenced to phase 2:NER and 6:WBSB, Start of Green
 Control Type: Pretimed
 ! Phase conflict between lane groups.



Lane Group	WBT	NBL	NBR	SBL	SBR2	NER
Lane Group Flow (vph)	1214	135	107	132	266	1371
v/c Ratio	0.57	0.16	0.14	0.22	0.34	1.14
Control Delay	13.4	7.0	5.7	12.1	7.9	92.6
Queue Delay	0.0	0.0	0.0	0.0	0.0	0.0
Total Delay	13.4	7.0	5.7	12.1	7.9	92.6
Queue Length 50th (m)	29.5	5.5	3.3	7.6	10.9	~61.5
Queue Length 95th (m)	m38.5	12.3	9.1	17.1	22.4	#89.8
Internal Link Dist (m)	512.6					
Turn Bay Length (m)						
Base Capacity (vph)	2136	865	786	590	786	1203
Starvation Cap Reductn	0	0	0	0	0	0
Spillback Cap Reductn	0	0	0	0	0	0
Storage Cap Reductn	0	0	0	0	0	0
Reduced v/c Ratio	0.57	0.16	0.14	0.22	0.34	1.14

Intersection Summary

~ Volume exceeds capacity, queue is theoretically infinite.

Queue shown is maximum after two cycles.

95th percentile volume exceeds capacity, queue may be longer.

Queue shown is maximum after two cycles.

m Volume for 95th percentile queue is metered by upstream signal.



Lane Group	WBT	NBL	NBR	SBL	SBR2	NER
Enter Blocked Intersection	No	No	No	No	No	No
Lane Alignment	Left	Left	Right	Left	Right	Right
Median Width(m)	8.0					
Link Offset(m)	0.0					
Crosswalk Width(m)	4.8					
Two way Left Turn Lane						
Headway Factor	1.00	1.00	1.00	1.00	1.00	1.00
Turning Speed (k/h)		25	15	25	15	15
Intersection Summary						



Movement	WBT	NBL	NBR	SBL	SBR2	NER
Lane Configurations	↑↑↑↑	↖	↗	↖	↗	↗↗↗
Volume (vph)	1117	124	98	121	245	1261
Pedestrians						
Ped Button						
Pedestrian Timing (s)						
Free Right			No		No	No
Ideal Flow	1900	1900	1900	1900	1900	1900
Lost Time (s)	4.0	4.0	4.0	4.0	4.0	4.0
Minimum Green (s)	4.0	4.0	4.0	4.0	4.0	4.0
Refr Cycle Length (s)	120	120	120	120	120	120
Volume Combined (vph)	1117	124	98	121	245	1261
Lane Utilization Factor	0.91	1.00	1.00	1.00	1.00	0.89
Turning Factor (vph)	1.00	0.95	0.85	0.95	0.85	0.85
Saturated Flow (vph)	6901	1805	1615	1805	1615	4288
Ped Intf Time (s)	0.0	0.0	0.0	0.0	0.0	0.0
Pedestrian Frequency (%)	0.00					
Protected Option Allowed	Yes					
Reference Time (s)	19.4	8.2	7.3	8.0	18.2	35.3
Adj Reference Time (s)	23.4	12.2	11.3	12.0	22.2	39.3
Permitted Option						
Adj Saturation A (vph)	1725	120		120		
Reference Time A (s)	19.4	123.7		120.7		
Adj Saturation B (vph)	6901	0		0		
Reference Time B (s)	19.4	16.2		16.0		
Reference Time (s)	19.4					
Adj Reference Time (s)	23.4					
Split Option						
Ref Time Combined (s)	19.4	8.2		8.0		
Ref Time Seperate (s)	19.4	8.2		8.0		
Reference Time (s)	19.4	8.2		8.0		
Adj Reference Time (s)	23.4	12.2		12.0		
Summary	EB WB	NB SB	NE	Combined		
Protected Option (s)	23.4	12.2	NA			
Permitted Option (s)	23.4	20.2	Err			
Split Option (s)	23.4	24.3	0.0			
Minimum (s)	23.4	12.2	0.0		35.7	
Right Turns	NBR	SBR2	NER			
Adj Reference Time (s)	11.3	22.2	39.3			
Cross Thru Ref Time (s)	0.0	23.4	0.0			
Oncoming Left Ref Time (s)	12.0	12.2	12.2			
Combined (s)	62.6	57.9	62.6			

Intersection Summary

Intersection Capacity Utilization 52.2% ICU Level of Service A
Reference Times and Phasing Options do not represent an optimized timing plan.



Approach	EB	WB	NB	SB	NE
Crosswalk Length (m)	4.70	11.27	2.91	2.20	4.90
Crosswalk Width (m)	1.20	1.20	1.20	1.20	1.20
Total Number of Lanes Crossed	4	8	2	2	3
Number of Right-Turn Islands	0	0	0	0	0
Type of Control	None	None	None	None	None
Corresponding Signal Phase	0	0	0	0	0
Effective Walk Time (s)	0.0	0.0	0.0	0.0	0.0
Right Corner Size A (m)	2.74	2.74	2.74	2.74	2.74
Right Corner Size B (m)	2.74	2.74	2.74	2.74	2.74
Right Corner Curb Radius (m)	0.00	0.00	0.00	0.00	0.00
Right Corner Total Area (sq.m)	7.51	7.51	7.51	7.51	7.51
Ped. Left-Right Flow Rate (p/h)	0	0	0	0	0
Ped. Right-Left Flow Rate (p/h)	0	0	0	0	0
Ped. R. Sidewalk Flow Rate (p/h)	0	0	0	0	0
Veh. Perm. L. Flow in Walk (v/h)	0	0	0	0	0
Veh. Perm. R. Flow in Walk (v/h)	0	0	0	0	0
Veh. RTOR Flow in Walk (v/h)	0	0	0	0	0
85th percentile speed (km/h)	50	50	50	50	50
Right Corner Area per Ped (sq.m)	0.0	0.0	0.0	0.0	0.0
Right Corner Quality of Service	-	-	-	-	-
Ped. Circulation Area (sq.m)	0.0	0.0	0.0	0.0	0.0
Crosswalk Circulation Code	-	-	-	-	-
Pedestrian Delay (s/p)	22.5	22.5	22.5	22.5	22.5
Pedestrian Compliance Code	Fair	Fair	Fair	Fair	Fair
Pedestrian Crosswalk Score	2.52	3.06	1.82	1.90	2.38
Pedestrian Crosswalk LOS	C	C	B	B	B



Approach	EB	WB	NB	SB	NE
Bicycle Flow Rate (bike/h)	0	0	0	0	0
Total Flow Rate (veh/h)	0	1214	242	398	1371
Effct. Green for Bike (s)	0.0	15.0	0.0	0.0	0.0
Cross Street Width (m)	16.07	7.23	36.99	15.43	9.55
Through Lanes Number	0	4	0	0	0
Through Lane Width (m)	3.60	3.60	3.60	3.60	3.60
Bicycle Lane Width (m)	0.00	0.00	0.00	0.00	0.00
Striped Parking Lane Width (m)	0.00	0.00	0.00	0.00	0.00
Paved Shoulder Width (m)	0.00	0.00	0.00	0.00	0.00
Curb Is Present?	No	No	No	No	No
On Street Parking?	No	No	No	No	No
Bicycle Lane Capacity (bike/h)	0	667	0	0	0
Bicycle Delay (s/bike)	0.0	10.0	0.0	0.0	0.0
Bicycle Compliance	Good				
Bicycle LOS Score	0.00	2.46	0.00	0.00	0.00
Bicycle LOS	B				



Lane Group	EBL	EBT	EBR	WBL	WBT	WBR	NBL	NBT	NBR	SBL	SBT	SBR
Lane Configurations					4111			4			1	
Traffic Volume (vph)	0	0	0	80	1421	25	34	156	0	0	31	21
Future Volume (vph)	0	0	0	80	1421	25	34	156	0	0	31	21
Ideal Flow (vphpl)	1900	1900	1900	1900	1900	1900	1900	1900	1900	1900	1900	1900
Lane Util. Factor	1.00	1.00	1.00	0.86	0.86	0.86	1.00	1.00	1.00	1.00	1.00	1.00
Fr _t					0.998						0.946	
Flt Protected					0.997			0.991				
Satd. Flow (prot)	0	0	0	0	6376	0	0	1846	0	0	1762	0
Flt Permitted					0.997			0.991				
Satd. Flow (perm)	0	0	0	0	6376	0	0	1846	0	0	1762	0
Link Speed (k/h)		50			50			50			50	
Link Distance (m)		104.2			139.5			94.5			152.6	
Travel Time (s)		7.5			10.0			6.8			11.0	
Peak Hour Factor	0.92	0.92	0.92	0.92	0.92	0.92	0.92	0.92	0.92	0.92	0.92	0.92
Adj. Flow (vph)	0	0	0	87	1545	27	37	170	0	0	34	23
Shared Lane Traffic (%)												
Lane Group Flow (vph)	0	0	0	0	1659	0	0	207	0	0	57	0
Enter Blocked Intersection	No	No	No	No	No	No	No	No	No	No	No	No
Lane Alignment	Left	Left	Right	Left	Left	Right	Left	Left	Right	Left	Left	Right
Median Width(m)		0.0			0.0			5.0			5.0	
Link Offset(m)		0.0			0.0			0.0			0.0	
Crosswalk Width(m)		4.8			4.8			4.8			4.8	
Two way Left Turn Lane												
Headway Factor	1.00	1.00	1.00	1.00	1.00	1.00	1.00	1.00	1.00	1.00	1.00	1.00
Turning Speed (k/h)	25		15	25		15	25		15	25		15
Sign Control		Free			Free			Stop			Stop	

Intersection Summary

Area Type:	Other
Control Type:	Unsignalized
Intersection Capacity Utilization	45.6%
ICU Level of Service	A
Analysis Period (min)	15



Lane Group	EBL	EBT	EBR	WBL	WBT	WBR	NBL	NBT	NBR	SBL	SBT	SBR
Lane Configurations					4111			4			1	
Ideal Flow (vphpl)	1900	1900	1900	1900	1900	1900	1900	1900	1900	1900	1900	1900
Lane Width (m)	3.6	3.6	3.6	3.6	3.6	3.6	3.6	3.6	3.6	3.6	3.6	3.6
Grade (%)		0%			0%			0%			0%	
Storage Length (m)	0.0		0.0	0.0		0.0	0.0		0.0	0.0		0.0
Storage Lanes	0		0	0		0	0		0	0		0
Taper Length (m)	7.5			7.5			7.5			7.5		
Lane Util. Factor	1.00	1.00	1.00	0.86	0.86	0.86	1.00	1.00	1.00	1.00	1.00	1.00
Ped Bike Factor												
Frt					0.998							0.946
Flt Protected					0.997			0.991				
Satd. Flow (prot)	0	0	0	0	6376	0	0	1846	0	0	1762	0
Flt Permitted					0.997			0.991				
Satd. Flow (perm)	0	0	0	0	6376	0	0	1846	0	0	1762	0
Link Speed (k/h)		50			50			50			50	
Link Distance (m)		104.2			139.5			94.5			152.6	
Travel Time (s)		7.5			10.0			6.8			11.0	

Intersection Summary

Area Type: Other

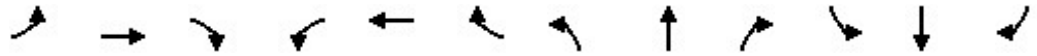

Lane Group	EBL	EBT	EBR	WBL	WBT	WBR	NBL	NBT	NBR	SBL	SBT	SBR
Traffic Volume (vph)	0	0	0	80	1421	25	34	156	0	0	31	21
Future Volume (vph)	0	0	0	80	1421	25	34	156	0	0	31	21
Confl. Peds. (#/hr)												
Confl. Bikes (#/hr)												
Peak Hour Factor	0.92	0.92	0.92	0.92	0.92	0.92	0.92	0.92	0.92	0.92	0.92	0.92
Growth Factor	100%	100%	100%	100%	100%	100%	100%	100%	100%	100%	100%	100%
Heavy Vehicles (%)	2%	2%	2%	2%	2%	2%	2%	2%	2%	2%	2%	2%
Bus Blockages (#/hr)	0	0	0	0	0	0	0	0	0	0	0	0
Parking (#/hr)												
Mid-Block Traffic (%)		0%			0%			0%			0%	
Adj. Flow (vph)	0	0	0	87	1545	27	37	170	0	0	34	23
Shared Lane Traffic (%)												
Lane Group Flow (vph)	0	0	0	0	1659	0	0	207	0	0	57	0

Intersection Summary

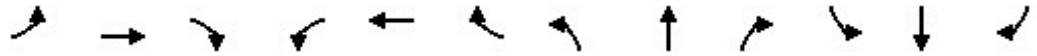

Lane Group	EBL	EBT	EBR	WBL	WBT	WBR	NBL	NBT	NBR	SBL	SBT	SBR
Enter Blocked Intersection	No	No	No	No	No	No	No	No	No	No	No	No
Lane Alignment	Left	Left	Right	Left	Left	Right	Left	Left	Right	Left	Left	Right
Median Width(m)		0.0			0.0			5.0			5.0	
Link Offset(m)		0.0			0.0			0.0			0.0	
Crosswalk Width(m)		4.8			4.8			4.8			4.8	
Two way Left Turn Lane												
Headway Factor	1.00	1.00	1.00	1.00	1.00	1.00	1.00	1.00	1.00	1.00	1.00	1.00
Turning Speed (k/h)	25		15	25		15	25		15	25		15

Intersection Summary



Movement	EBL	EBT	EBR	WBL	WBT	WBR	NBL	NBT	NBR	SBL	SBT	SBR
Lane Configurations												
Volume (vph)	0	0	0	80	1421	25	34	156	0	0	31	21
Pedestrians												
Ped Button												
Pedestrian Timing (s)												
Free Right	No			No			No			No		
Ideal Flow	1900	1900	1900	1900	1900	1900	1900	1900	1900	1900	1900	1900
Lost Time (s)	4.0	4.0	4.0	4.0	4.0	4.0	4.0	4.0	4.0	4.0	4.0	4.0
Minimum Green (s)	4.0	4.0	4.0	4.0	4.0	4.0	4.0	4.0	4.0	4.0	4.0	4.0
Refr Cycle Length (s)	120	120	120	120	120	120	120	120	120	120	120	120
Volume Combined (vph)	0	0	0	0	1526	0	0	190	0	0	52	0
Lane Utilization Factor	1.00	1.00	1.00	1.00	0.91	1.00	1.00	1.00	1.00	1.00	1.00	1.00
Turning Factor (vph)	0.95	1.00	0.85	0.95	0.99	0.85	0.95	0.99	0.85	0.95	0.94	0.85
Saturated Flow (vph)	0	0	0	0	6866	0	0	1883	0	0	1785	0
Ped Intf Time (s)	0.0	0.0	0.0	0.0	0.0	0.0	0.0	0.0	0.0	0.0	0.0	0.0
Pedestrian Frequency (%)	0.00			0.00			0.00			0.00		
Protected Option Allowed	No			No			No			No		
Reference Time (s)	0.0			0.0			0.0			0.0		
Adj Reference Time (s)	0.0			0.0			0.0			0.0		
Permitted Option												
Adj Saturation A (vph)	0	0	0	177	0	508	0	1785	0	1785	0	1785
Reference Time A (s)	0.0	0.0	0.0	96.1	0.0	44.9	0.0	3.5	0.0	3.5	0.0	3.5
Adj Saturation B (vph)	NA	NA	0	5162	0	0	NA	NA	NA	NA	NA	NA
Reference Time B (s)	NA	NA	13.3	28.7	10.3	20.1	NA	NA	NA	NA	NA	NA
Reference Time (s)	0.0			28.7			20.1			3.5		
Adj Reference Time (s)	8.0			32.7			24.1			8.0		
Split Option												
Ref Time Combined (s)	0.0	0.0	0.0	26.7	0.0	12.1	0.0	3.5	0.0	3.5	0.0	3.5
Ref Time Seperate (s)	0.0	0.0	5.3	24.8	2.3	9.9	0.0	2.1	0.0	2.1	0.0	2.1
Reference Time (s)	0.0	0.0	26.7	26.7	12.1	12.1	3.5	3.5	0.0	3.5	0.0	3.5
Adj Reference Time (s)	0.0	0.0	30.7	30.7	16.1	16.1	8.0	8.0	0.0	8.0	0.0	8.0
Summary	EB WB		NB SB		Combined							
Protected Option (s)	NA		NA									
Permitted Option (s)	32.7		24.1									
Split Option (s)	30.7		24.1									
Minimum (s)	30.7		24.1		54.8							
Right Turns												
Adj Reference Time (s)												
Cross Thru Ref Time (s)												
Oncoming Left Ref Time (s)												
Combined (s)												
Intersection Summary												
Intersection Capacity Utilization	45.6%			ICU Level of Service					A			
Reference Times and Phasing Options do not represent an optimized timing plan.												



Approach

Approach Direction EB
 Median Present? No
 Approach Delay 4.28103910070758E25
 Level of Service F

Crosswalk

Length (ft) 173
 Lanes Crossed 4
 Veh Vol Crossed 1421
 Ped Vol Crossed 0
 Yield Rate(%) 0
 Ped Platooning No

Critical Headway (s) 147.17
 Prob of Delayed X-ing 1.00
 Prob of Blocked Lane 1.00
 Delay for add 4.28103910070758E25
 Avg Ped Delay 4.28103910070758E25

Approach

Approach Direction WB
 Median Present? No
 Approach Delay 3.0818303987229E25
 Level of Service F

Crosswalk

Length (ft) 172
 Lanes Crossed 4
 Veh Vol Crossed 1421
 Ped Vol Crossed 0
 Yield Rate(%) 0
 Ped Platooning No

Critical Headway (s) 146.33
 Prob of Delayed X-ing 1.00
 Prob of Blocked Lane 1.00
 Delay for add 3.0818303987229E25
 Avg Ped Delay 3.0818303987229E25

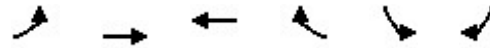

Lane Group	EBL	EBT	WBT	WBR	SBL	SBR
Lane Configurations			↑↑↑↑	↑		↑
Traffic Volume (vph)	0	0	1418	75	0	84
Future Volume (vph)	0	0	1418	75	0	84
Ideal Flow (vphpl)	1900	1900	1900	1900	1900	1900
Lane Util. Factor	1.00	1.00	0.91	1.00	1.00	1.00
Fr _t				0.850		0.865
Flt Protected						
Satd. Flow (prot)	0	0	5085	1583	0	1611
Flt Permitted						
Satd. Flow (perm)	0	0	5085	1583	0	1611
Right Turn on Red				Yes		Yes
Satd. Flow (RTOR)				82		41
Link Speed (k/h)		50	50		50	
Link Distance (m)		73.5	104.2		158.0	
Travel Time (s)		5.3	7.5		11.4	
Peak Hour Factor	0.92	0.92	0.92	0.92	0.92	0.92
Adj. Flow (vph)	0	0	1541	82	0	91
Shared Lane Traffic (%)						
Lane Group Flow (vph)	0	0	1541	82	0	91
Enter Blocked Intersection	No	No	No	No	No	No
Lane Alignment	Left	Left	Left	Right	Left	Right
Median Width(m)		0.0	0.0		0.0	
Link Offset(m)		0.0	0.0		0.0	
Crosswalk Width(m)		4.8	4.8		4.8	
Two way Left Turn Lane						
Headway Factor	1.00	1.00	1.00	1.00	1.00	1.00
Turning Speed (k/h)	25			15	25	15
Turn Type			NA	Perm		Perm
Protected Phases			8			
Permitted Phases				8		6
Minimum Split (s)			20.0	20.0		20.0
Total Split (s)			61.0	61.0		29.0
Total Split (%)			67.8%	67.8%		32.2%
Maximum Green (s)			57.0	57.0		25.0
Yellow Time (s)			3.5	3.5		3.5
All-Red Time (s)			0.5	0.5		0.5
Lost Time Adjust (s)			0.0	0.0		0.0
Total Lost Time (s)			4.0	4.0		4.0
Lead/Lag						
Lead-Lag Optimize?						
Walk Time (s)			5.0	5.0		5.0
Flash Dont Walk (s)			11.0	11.0		11.0
Pedestrian Calls (#/hr)			0	0		0
Act Effect Green (s)			57.0	57.0		25.0
Actuated g/C Ratio			0.63	0.63		0.28
v/c Ratio			0.48	0.08		0.19
Control Delay			7.4	1.6		16.1
Queue Delay			0.0	0.0		0.0
Total Delay			7.4	1.6		16.1

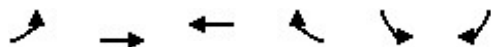

Lane Group	EBL	EBT	WBT	WBR	SBL	SBR
LOS			A	A		B
Approach Delay			7.1		16.1	
Approach LOS			A		B	
Stops (vph)			743	13		38
Fuel Used(l)			39	1		3
CO Emissions (g/hr)			721	21		59
NOx Emissions (g/hr)			139	4		11
VOC Emissions (g/hr)			166	5		14
Dilemma Vehicles (#)			0	0		0
Queue Length 50th (m)			52.8	0.0		6.8
Queue Length 95th (m)			52.5	m0.1		18.5
Internal Link Dist (m)		49.5	80.2		134.0	
Turn Bay Length (m)						
Base Capacity (vph)			3220	1032		477
Starvation Cap Reductn			0	0		0
Spillback Cap Reductn			199	0		1
Storage Cap Reductn			0	0		0
Reduced v/c Ratio			0.51	0.08		0.19

Intersection Summary

Area Type: Other
 Cycle Length: 90
 Actuated Cycle Length: 90
 Offset: 48 (53%), Referenc ed to phase 2: and 6: SBR, Sta t of Green
 Natural Cycle: 40
 Control Type: Pretimed
 Maximum v/c Ratio: 0.48
 Intersection Signal Delay: 7.6
 Intersection Capacity Utilization 39.3%
 Analysis Period (min) 15
 m Volume for 95th percentile queue is metered by upstream signal.

Splits and Phases: 9: Av. Infancia



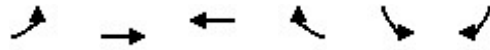

Lane Group	EBL	EBT	WBT	WBR	SBL	SBR
Lane Configurations			↑↑↑	↑		↑
Ideal Flow (vphpl)	1900	1900	1900	1900	1900	1900
Lane Width (m)	3.6	3.6	3.6	3.6	3.6	3.6
Grade (%)		0%	0%		0%	
Storage Length (m)	0.0			0.0	0.0	0.0
Storage Lanes	0			1	0	1
Taper Length (m)	7.5				7.5	
Lane Util. Factor	1.00	1.00	0.91	1.00	1.00	1.00
Ped Bike Factor						
Fr _t				0.850		0.865
Flt Protected						
Satd. Flow (prot)	0	0	5085	1583	0	1611
Flt Permitted						
Satd. Flow (perm)	0	0	5085	1583	0	1611
Right Turn on Red				Yes		Yes
Satd. Flow (RTOR)				82		41
Link Speed (k/h)		50	50		50	
Link Distance (m)		73.5	104.2		158.0	
Travel Time (s)		5.3	7.5		11.4	

Intersection Summary

Area Type: Other

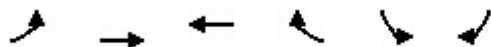

Lane Group	EBL	EBT	WBT	WBR	SBL	SBR
Traffic Volume (vph)	0	0	1418	75	0	84
Future Volume (vph)	0	0	1418	75	0	84
Confl. Peds. (#/hr)						
Confl. Bikes (#/hr)						
Peak Hour Factor	0.92	0.92	0.92	0.92	0.92	0.92
Growth Factor	100%	100%	100%	100%	100%	100%
Heavy Vehicles (%)	2%	2%	2%	2%	2%	2%
Bus Blockages (#/hr)	0	0	0	0	0	0
Parking (#/hr)						
Mid-Block Traffic (%)		0%	0%		0%	
Adj. Flow (vph)	0	0	1541	82	0	91
Shared Lane Traffic (%)						
Lane Group Flow (vph)	0	0	1541	82	0	91
Intersection Summary						



Lane Group	WBT	WBR	SBR
Lane Configurations	↑↑↑	↑	↑
Traffic Volume (vph)	1418	75	84
Future Volume (vph)	1418	75	84
Turn Type	NA	Perm	Perm
Protected Phases	8		
Permitted Phases		8	6
Detector Phase	8	8	6
Switch Phase			
Minimum Initial (s)	4.0	4.0	4.0
Minimum Split (s)	20.0	20.0	20.0
Total Split (s)	61.0	61.0	29.0
Total Split (%)	67.8%	67.8%	32.2%
Yellow Time (s)	3.5	3.5	3.5
All-Red Time (s)	0.5	0.5	0.5
Lost Time Adjust (s)	0.0	0.0	0.0
Total Lost Time (s)	4.0	4.0	4.0
Lead/Lag			
Lead-Lag Optimize?			
Recall Mode	Max	Max	Max
Act Effct Green (s)	57.0	57.0	25.0
Actuated g/C Ratio	0.63	0.63	0.28
v/c Ratio	0.48	0.08	0.19
Control Delay	7.4	1.6	16.1
Queue Delay	0.0	0.0	0.0
Total Delay	7.4	1.6	16.1
LOS	A	A	B
Approach Delay	7.1		
Approach LOS	A		

Intersection Summary

Cycle Length: 90
 Actuated Cycle Length: 90
 Offset: 48 (53%), Reference d to phase 2: and 6: SBR, Start of Green
 Natural Cycle: 40
 Control Type: Pretimed
 Maximum v/c Ratio: 0.48
 Intersection Signal Delay: 7.6
 Intersection Capacity Utilization 39.3%
 Analysis Period (min) 15

Intersection LOS: A
 ICU Level of Service A

Splits and Phases: 9: Av. Infancia





Lane Group	WBT	WBR	SBR
Protected Phases	8		
Permitted Phases		8	6
Minimum Initial (s)	4.0	4.0	4.0
Minimum Split (s)	20.0	20.0	20.0
Total Split (s)	61.0	61.0	29.0
Total Split (%)	67.8%	67.8%	32.2%
Maximum Green (s)	57.0	57.0	25.0
Yellow Time (s)	3.5	3.5	3.5
All-Red Time (s)	0.5	0.5	0.5
Lead/Lag			
Lead-Lag Optimize?			
Vehicle Extension (s)	3.0	3.0	3.0
Minimum Gap (s)	3.0	3.0	3.0
Time Before Reduce (s)	0.0	0.0	0.0
Time To Reduce (s)	0.0	0.0	0.0
Recall Mode	Max	Max	Max
Walk Time (s)	5.0	5.0	5.0
Flash Dont Walk (s)	11.0	11.0	11.0
Pedestrian Calls (#/hr)	0	0	0
90th %ile Green (s)	57.0	57.0	25.0
90th %ile Term Code	MaxR	MaxR	Coord
70th %ile Green (s)	57.0	57.0	25.0
70th %ile Term Code	MaxR	MaxR	Coord
50th %ile Green (s)	57.0	57.0	25.0
50th %ile Term Code	MaxR	MaxR	Coord
30th %ile Green (s)	57.0	57.0	25.0
30th %ile Term Code	MaxR	MaxR	Coord
10th %ile Green (s)	57.0	57.0	25.0
10th %ile Term Code	MaxR	MaxR	Coord

Intersection Summary

Cycle Length: 90
 Actuated Cycle Length: 90
 Offset: 48 (53%), Referenced to phase 2: and 6:SBR, Start of Green
 Control Type: Pretimed



Lane Group	WBT	WBR	SBR
Lane Group Flow (vph)	1541	82	91
v/c Ratio	0.48	0.08	0.19
Control Delay	7.4	1.6	16.1
Queue Delay	0.0	0.0	0.0
Total Delay	7.4	1.6	16.1
Queue Length 50th (m)	52.8	0.0	6.8
Queue Length 95th (m)	52.5	m0.1	18.5
Internal Link Dist (m)	80.2		
Turn Bay Length (m)			
Base Capacity (vph)	3220	1032	477
Starvation Cap Reductn	0	0	0
Spillback Cap Reductn	199	0	1
Storage Cap Reductn	0	0	0
Reduced v/c Ratio	0.51	0.08	0.19

Intersection Summary

m Volume for 95th percentile queue is metered by upstream signal.

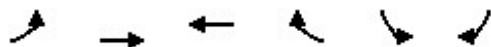

Lane Group	EBL	EBT	WBT	WBR	SBL	SBR
Enter Blocked Intersection	No	No	No	No	No	No
Lane Alignment	Left	Left	Left	Right	Left	Right
Median Width(m)		0.0	0.0		0.0	
Link Offset(m)		0.0	0.0		0.0	
Crosswalk Width(m)		4.8	4.8		4.8	
Two way Left Turn Lane						
Headway Factor	1.00	1.00	1.00	1.00	1.00	1.00
Turning Speed (k/h)	25			15	25	15
Intersection Summary						

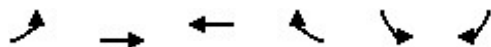

Movement	EBL	EBT	WBT	WBR	SBL	SBR
Lane Configurations			↑↑↑↑	↑		↑
Volume (vph)	0	0	1418	75	0	84
Pedestrians						
Ped Button						
Pedestrian Timing (s)						
Free Right				No		No
Ideal Flow	1900	1900	1900	1900	1900	1900
Lost Time (s)	4.0	4.0	4.0	4.0	4.0	4.0
Minimum Green (s)	4.0	4.0	4.0	4.0	4.0	4.0
Refr Cycle Length (s)	120	120	120	120	120	120
Volume Combined (vph)	0	0	1418	75	0	84
Lane Utilization Factor	1.00	1.00	0.91	1.00	1.00	1.00
Turning Factor (vph)	0.95	1.00	1.00	0.85	0.95	0.85
Saturated Flow (vph)	0	0	5176	1615	0	1615
Ped Intf Time (s)	0.0	0.0	0.0	0.0	0.0	0.0
Pedestrian Frequency (%)		0.00	0.00		0.00	
Protected Option Allowed		Yes	Yes		No	
Reference Time (s)	0.0	0.0	32.9	5.6		6.2
Adj Reference Time (s)	0.0	0.0	36.9	9.6		10.2
Permitted Option						
Adj Saturation A (vph)	0	0	1725		0	
Reference Time A (s)	0.0	0.0	32.9		0.0	
Adj Saturation B (vph)	NA	NA	5176		NA	
Reference Time B (s)	NA	NA	32.9		NA	
Reference Time (s)		0.0	32.9			
Adj Reference Time (s)		8.0	36.9			
Split Option						
Ref Time Combined (s)	0.0	0.0	32.9		0.0	
Ref Time Seperate (s)	0.0	0.0	32.9		0.0	
Reference Time (s)	0.0	0.0	32.9		0.0	
Adj Reference Time (s)	0.0	0.0	36.9		0.0	
Summary	EB WB		SB		Combined	
Protected Option (s)	36.9		NA			
Permitted Option (s)	36.9		Err			
Split Option (s)	36.9		0.0			
Minimum (s)	36.9		0.0		36.9	
Right Turns	WBR	SBR				
Adj Reference Time (s)	9.6	10.2				
Cross Thru Ref Time (s)	0.0	36.9				
Oncoming Left Ref Time (s)	0.0	0.0				
Combined (s)	9.6	47.1				

Intersection Summary			
Intersection Capacity Utilization	39.3%	ICU Level of Service	A
Reference Times and Phasing Options do not represent an optimized timing plan.			



Approach	EB	WB	SB
Crosswalk Length (m)	4.39	4.39	2.82
Crosswalk Width (m)	1.20	1.20	1.20
Total Number of Lanes Crossed	4	4	2
Number of Right-Turn Islands	0	0	0
Type of Control	None	None	None
Corresponding Signal Phase	0	0	8
Effective Walk Time (s)	0.0	0.0	0.0
Right Corner Size A (m)	2.74	2.74	2.74
Right Corner Size B (m)	2.74	2.74	2.74
Right Corner Curb Radius (m)	0.00	0.00	0.00
Right Corner Total Area (sq.m)	7.51	7.51	7.51
Ped. Left-Right Flow Rate (p/h)	0	0	0
Ped. Right-Left Flow Rate (p/h)	0	0	0
Ped. R. Sidewalk Flow Rate (p/h)	0	0	0
Veh. Perm. L. Flow in Walk (v/h)	0	0	0
Veh. Perm. R. Flow in Walk (v/h)	0	0	0
Veh. RTOR Flow in Walk (v/h)	0	0	0
85th percentile speed (km/h)	50	50	50
Right Corner Area per Ped (sq.m)	0.0	0.0	0.0
Right Corner Quality of Service	-	-	-
Ped. Circulation Area (sq.m)	0.0	0.0	0.0
Crosswalk Circulation Code	-	-	-
Pedestrian Delay (s/p)	45.0	45.0	45.0
Pedestrian Compliance Code	Poor	Poor	Poor
Pedestrian Crosswalk Score	2.55	2.55	1.81
Pedestrian Crosswalk LOS	C	C	B



Approach	EB	WB	SB
Bicycle Flow Rate (bike/h)	0	0	0
Total Flow Rate (veh/h)	0	1623	91
Effct. Green for Bike (s)	0.0	57.0	0.0
Cross Street Width (m)	14.41	9.24	14.40
Through Lanes Number	0	3	0
Through Lane Width (m)	3.60	3.60	3.60
Bicycle Lane Width (m)	0.00	0.00	0.00
Striped Parking Lane Width (m)	0.00	0.00	0.00
Paved Shoulder Width (m)	0.00	0.00	0.00
Curb Is Present?	No	No	No
On Street Parking?	No	No	No
Bicycle Lane Capacity (bike/h)	0	1267	0
Bicycle Delay (s/bike)	0.0	6.1	0.0
Bicycle Compliance	Good		
Bicycle LOS Score	0.00	2.96	0.00
Bicycle LOS	C		



Lane Group	EBL	EBT	EBR	WBL	WBT	WBR	NBL	NBT	NBR	SBL	SBT	SBR
Lane Configurations		↑↑↑↓			↑↑↑↓			↑↓			↑↓	
Traffic Volume (vph)	0	1263	119	0	904	172	115	598	65	41	560	98
Future Volume (vph)	0	1263	119	0	904	172	115	598	65	41	560	98
Ideal Flow (vphpl)	1900	1900	1900	1900	1900	1900	1900	1900	1900	1900	1900	1900
Lane Util. Factor	1.00	0.86	0.86	1.00	0.86	0.86	1.00	1.00	1.00	1.00	1.00	1.00
Fr't		0.987			0.976			0.989			0.981	
Flt Protected								0.993			0.997	
Satd. Flow (prot)	0	6325	0	0	6254	0	0	1829	0	0	1822	0
Flt Permitted								0.652			0.900	
Satd. Flow (perm)	0	6325	0	0	6254	0	0	1201	0	0	1645	0
Right Turn on Red			Yes			Yes			Yes			Yes
Satd. Flow (RTOR)		33			75			6			11	
Link Speed (k/h)		50			50			50			50	
Link Distance (m)		536.6			663.1			156.7			214.1	
Travel Time (s)		38.6			47.7			11.3			15.4	
Peak Hour Factor	0.92	0.92	0.92	0.92	0.92	0.92	0.92	0.92	0.92	0.92	0.92	0.92
Adj. Flow (vph)	0	1373	129	0	983	187	125	650	71	45	609	107
Shared Lane Traffic (%)												
Lane Group Flow (vph)	0	1502	0	0	1170	0	0	846	0	0	761	0
Enter Blocked Intersection	No	No	No	No	No	No	No	No	No	No	No	No
Lane Alignment	Left	Left	Right	Left	Left	Right	Left	Left	Right	Left	Left	Right
Median Width(m)		3.0			3.0			0.0			0.0	
Link Offset(m)		0.0			0.0			0.0			0.0	
Crosswalk Width(m)		4.8			4.8			4.8			4.8	
Two way Left Turn Lane												
Headway Factor	1.00	1.00	1.00	1.00	1.00	1.00	1.00	1.00	1.00	1.00	1.00	1.00
Turning Speed (k/h)		25		15	25		15	25		15	25	
Turn Type		NA			NA		Perm	NA		Perm	NA	
Protected Phases		4			8			2			6	
Permitted Phases							2			6		
Minimum Split (s)		20.0			20.0		20.0	20.0		20.0	20.0	
Total Split (s)		48.0			48.0		42.0	42.0		42.0	42.0	
Total Split (%)		53.3%			53.3%		46.7%	46.7%		46.7%	46.7%	
Maximum Green (s)		44.0			44.0		38.0	38.0		38.0	38.0	
Yellow Time (s)		3.5			3.5		3.5	3.5		3.5	3.5	
All-Red Time (s)		0.5			0.5		0.5	0.5		0.5	0.5	
Lost Time Adjust (s)		0.0			0.0			0.0			0.0	
Total Lost Time (s)		4.0			4.0			4.0			4.0	
Lead/Lag												
Lead-Lag Optimize?												
Walk Time (s)		5.0			5.0		5.0	5.0		5.0	5.0	
Flash Dont Walk (s)		11.0			11.0		11.0	11.0		11.0	11.0	
Pedestrian Calls (#/hr)		0			0		0	0		0	0	
Act Effct Green (s)		44.0			44.0			38.0			38.0	
Actuated g/C Ratio		0.49			0.49			0.42			0.42	
v/c Ratio		0.48			0.38			1.66			1.09	
Control Delay		10.2			13.8			328.8			87.2	
Queue Delay		0.0			0.0			0.0			0.0	
Total Delay		10.2			13.8			328.8			87.2	



Lane Group	EBL	EBT	EBR	WBL	WBT	WBR	NBL	NBT	NBR	SBL	SBT	SBR
LOS		B			B			F			F	
Approach Delay		10.2			13.8			328.8			87.2	
Approach LOS		B			B			F			F	
Stops (vph)		700			594			561			572	
Fuel Used(l)		97			93			221			74	
CO Emissions (g/hr)		1803			1721			4111			1377	
NOx Emissions (g/hr)		348			332			793			266	
VOC Emissions (g/hr)		416			397			948			317	
Dilemma Vehicles (#)		0			0			0			0	
Queue Length 50th (m)		41.9			34.4			~228.2			~156.3	
Queue Length 95th (m)		m38.6			42.6			#301.7			#227.5	
Internal Link Dist (m)		512.6			639.1			132.7			190.1	
Turn Bay Length (m)												
Base Capacity (vph)		3109			3095			510			700	
Starvation Cap Reductn		0			0			0			0	
Spillback Cap Reductn		0			0			0			0	
Storage Cap Reductn		0			0			0			0	
Reduced v/c Ratio		0.48			0.38			1.66			1.09	

Intersection Summary

Area Type: Other
 Cycle Length: 90
 Actuated Cycle Length: 90
 Offset: 63 (70%), Referenc ed to phase 2:NBTL and 6:SBTL, Start of Green
 Natural Cycle: 60
 Control Type: Pretimed
 Maximum v/c Ratio: 1.66
 Intersection Signal Delay: 87.9 Intersection LOS: F
 Intersection Capacity Utilization 101.5% ICU Level of Service G
 Analysis Period (min) 15
 ~ Volume exceeds capacity, queue is theoretically infinite.
 Queue shown is maximum after two cycles.
 # 95th percentile volume exceeds capacity, queue may be longer.
 Queue shown is maximum after two cycles.
 m Volume for 95th percentile queue is metered by upstream signal.

Splits and Phases: 10: Ca. La Union/Jr. Los Sauces & AV. 28 DE JULIO

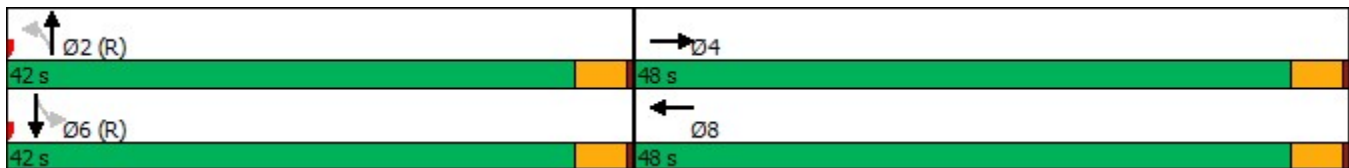



Lane Group	EBL	EBT	EBR	WBL	WBT	WBR	NBL	NBT	NBR	SBL	SBT	SBR
Lane Configurations												
Ideal Flow (vphpl)	1900	1900	1900	1900	1900	1900	1900	1900	1900	1900	1900	1900
Lane Width (m)	3.6	3.6	3.6	3.6	3.6	3.6	3.6	3.6	3.6	3.6	3.6	3.6
Grade (%)		0%			0%			0%			0%	
Storage Length (m)	0.0		0.0	0.0		0.0	0.0		0.0	0.0		0.0
Storage Lanes	0		0	0		0	0		0	0		0
Taper Length (m)	7.5			7.5			7.5			7.5		
Lane Util. Factor	1.00	0.86	0.86	1.00	0.86	0.86	1.00	1.00	1.00	1.00	1.00	1.00
Ped Bike Factor												
Frt		0.987			0.976			0.989			0.981	
Flt Protected								0.993			0.997	
Satd. Flow (prot)	0	6325	0	0	6254	0	0	1829	0	0	1822	0
Flt Permitted								0.652			0.900	
Satd. Flow (perm)	0	6325	0	0	6254	0	0	1201	0	0	1645	0
Right Turn on Red			Yes			Yes			Yes			Yes
Satd. Flow (RTOR)		33			75			6			11	
Link Speed (k/h)		50			50			50			50	
Link Distance (m)		536.6			663.1			156.7			214.1	
Travel Time (s)		38.6			47.7			11.3			15.4	

Intersection Summary

Area Type: Other



Lane Group	EBL	EBT	EBR	WBL	WBT	WBR	NBL	NBT	NBR	SBL	SBT	SBR
Traffic Volume (vph)	0	1263	119	0	904	172	115	598	65	41	560	98
Future Volume (vph)	0	1263	119	0	904	172	115	598	65	41	560	98
Confl. Peds. (#/hr)												
Confl. Bikes (#/hr)												
Peak Hour Factor	0.92	0.92	0.92	0.92	0.92	0.92	0.92	0.92	0.92	0.92	0.92	0.92
Growth Factor	100%	100%	100%	100%	100%	100%	100%	100%	100%	100%	100%	100%
Heavy Vehicles (%)	2%	2%	2%	2%	2%	2%	2%	2%	2%	2%	2%	2%
Bus Blockages (#/hr)	0	0	0	0	0	0	0	0	0	0	0	0
Parking (#/hr)												
Mid-Block Traffic (%)		0%			0%			0%			0%	
Adj. Flow (vph)	0	1373	129	0	983	187	125	650	71	45	609	107
Shared Lane Traffic (%)												
Lane Group Flow (vph)	0	1502	0	0	1170	0	0	846	0	0	761	0

Intersection Summary



Lane Group	EBT	WBT	NBL	NBT	SBL	SBT
Lane Configurations	↑↑↑↑	↑↑↑↑		↕		↕
Traffic Volume (vph)	1263	904	115	598	41	560
Future Volume (vph)	1263	904	115	598	41	560
Turn Type	NA	NA	Perm	NA	Perm	NA
Protected Phases	4	8		2		6
Permitted Phases			2		6	
Detector Phase	4	8	2	2	6	6
Switch Phase						
Minimum Initial (s)	4.0	4.0	4.0	4.0	4.0	4.0
Minimum Split (s)	20.0	20.0	20.0	20.0	20.0	20.0
Total Split (s)	48.0	48.0	42.0	42.0	42.0	42.0
Total Split (%)	53.3%	53.3%	46.7%	46.7%	46.7%	46.7%
Yellow Time (s)	3.5	3.5	3.5	3.5	3.5	3.5
All-Red Time (s)	0.5	0.5	0.5	0.5	0.5	0.5
Lost Time Adjust (s)	0.0	0.0		0.0		0.0
Total Lost Time (s)	4.0	4.0		4.0		4.0
Lead/Lag						
Lead-Lag Optimize?						
Recall Mode	Max	Max	Max	Max	Max	Max
Act Effect Green (s)	44.0	44.0		38.0		38.0
Actuated g/C Ratio	0.49	0.49		0.42		0.42
v/c Ratio	0.48	0.38		1.66		1.09
Control Delay	10.2	13.8		328.8		87.2
Queue Delay	0.0	0.0		0.0		0.0
Total Delay	10.2	13.8		328.8		87.2
LOS	B	B		F		F
Approach Delay	10.2	13.8		328.8		87.2
Approach LOS	B	B		F		F

Intersection Summary

Cycle Length: 90
 Actuated Cycle Length: 90
 Offset: 63 (70%), Reference d to phase 2:NBT and 6:SBTL, Start of Green
 Natural Cycle: 60
 Control Type: Pretimed
 Maximum v/c Ratio: 1.66
 Intersection Signal Delay: 87.9
 Intersection Capacity Utilization 101.5%
 Analysis Period (min) 15
 Intersection LOS: F
 ICU Level of Service G

Splits and Phases: 10. Ca. La Union/Jr. Los Sauces & AV. 28 DE JULIO

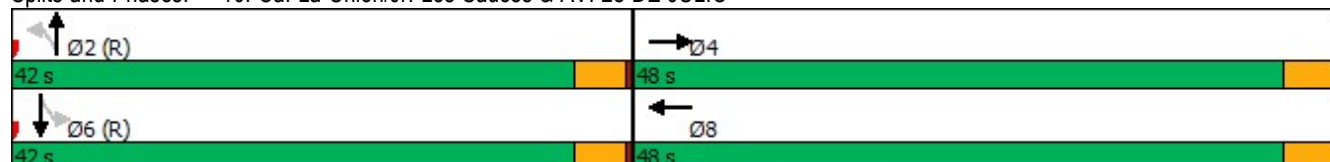



Lane Group	EBT	WBT	NBL	NBT	SBL	SBT
Protected Phases	4	8		2		6
Permitted Phases			2		6	
Minimum Initial (s)	4.0	4.0	4.0	4.0	4.0	4.0
Minimum Split (s)	20.0	20.0	20.0	20.0	20.0	20.0
Total Split (s)	48.0	48.0	42.0	42.0	42.0	42.0
Total Split (%)	53.3%	53.3%	46.7%	46.7%	46.7%	46.7%
Maximum Green (s)	44.0	44.0	38.0	38.0	38.0	38.0
Yellow Time (s)	3.5	3.5	3.5	3.5	3.5	3.5
All-Red Time (s)	0.5	0.5	0.5	0.5	0.5	0.5
Lead/Lag						
Lead-Lag Optimize?						
Vehicle Extension (s)	3.0	3.0	3.0	3.0	3.0	3.0
Minimum Gap (s)	3.0	3.0	3.0	3.0	3.0	3.0
Time Before Reduce (s)	0.0	0.0	0.0	0.0	0.0	0.0
Time To Reduce (s)	0.0	0.0	0.0	0.0	0.0	0.0
Recall Mode	Max	Max	Max	Max	Max	Max
Walk Time (s)	5.0	5.0	5.0	5.0	5.0	5.0
Flash Dont Walk (s)	11.0	11.0	11.0	11.0	11.0	11.0
Pedestrian Calls (#/hr)	0	0	0	0	0	0
90th %ile Green (s)	44.0	44.0	38.0	38.0	38.0	38.0
90th %ile Term Code	MaxR	MaxR	Coord	Coord	Coord	Coord
70th %ile Green (s)	44.0	44.0	38.0	38.0	38.0	38.0
70th %ile Term Code	MaxR	MaxR	Coord	Coord	Coord	Coord
50th %ile Green (s)	44.0	44.0	38.0	38.0	38.0	38.0
50th %ile Term Code	MaxR	MaxR	Coord	Coord	Coord	Coord
30th %ile Green (s)	44.0	44.0	38.0	38.0	38.0	38.0
30th %ile Term Code	MaxR	MaxR	Coord	Coord	Coord	Coord
10th %ile Green (s)	44.0	44.0	38.0	38.0	38.0	38.0
10th %ile Term Code	MaxR	MaxR	Coord	Coord	Coord	Coord

Intersection Summary

Cycle Length: 90

Actuated Cycle Length: 90

Offset: 63 (70%), Referenced to phase 2:NBTL and 6:SBTL, Start of Green

Control Type: Pretimed

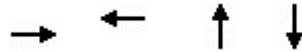

Lane Group	EBT	WBT	NBT	SBT
Lane Group Flow (vph)	1502	1170	846	761
v/c Ratio	0.48	0.38	1.66	1.09
Control Delay	10.2	13.8	328.8	87.2
Queue Delay	0.0	0.0	0.0	0.0
Total Delay	10.2	13.8	328.8	87.2
Queue Length 50th (m)	41.9	34.4	~228.2	~156.3
Queue Length 95th (m)	m38.6	42.6	#301.7	#227.5
Internal Link Dist (m)	512.6	639.1	132.7	190.1
Turn Bay Length (m)				
Base Capacity (vph)	3109	3095	510	700
Starvation Cap Reductn	0	0	0	0
Spillback Cap Reductn	0	0	0	0
Storage Cap Reductn	0	0	0	0
Reduced v/c Ratio	0.48	0.38	1.66	1.09

Intersection Summary

~ Volume exceeds capacity, queue is theoretically infinite.

Queue shown is maximum after two cycles.

95th percentile volume exceeds capacity, queue may be longer.

Queue shown is maximum after two cycles.

m Volume for 95th percentile queue is metered by upstream signal.



Lane Group	EBL	EBT	EBR	WBL	WBT	WBR	NBL	NBT	NBR	SBL	SBT	SBR
Enter Blocked Intersection	No	No	No	No	No	No	No	No	No	No	No	No
Lane Alignment	Left	Left	Right	Left	Left	Right	Left	Left	Right	Left	Left	Right
Median Width(m)		3.0			3.0			0.0			0.0	
Link Offset(m)		0.0			0.0			0.0			0.0	
Crosswalk Width(m)		4.8			4.8			4.8			4.8	
Two way Left Turn Lane												
Headway Factor	1.00	1.00	1.00	1.00	1.00	1.00	1.00	1.00	1.00	1.00	1.00	1.00
Turning Speed (k/h)	25		15	25		15	25		15	25		15

Intersection Summary



Movement	EBL	EBT	EBR	WBL	WBT	WBR	NBL	NBT	NBR	SBL	SBT	SBR
Lane Configurations		↑↑↑			↑↑↑			↕			↕	
Volume (vph)	0	1263	119	0	904	172	115	598	65	41	560	98
Pedestrians												
Ped Button												
Pedestrian Timing (s)												
Free Right			No			No			No			No
Ideal Flow	1900	1900	1900	1900	1900	1900	1900	1900	1900	1900	1900	1900
Lost Time (s)	4.0	4.0	4.0	4.0	4.0	4.0	4.0	4.0	4.0	4.0	4.0	4.0
Minimum Green (s)	4.0	4.0	4.0	4.0	4.0	4.0	4.0	4.0	4.0	4.0	4.0	4.0
Refr Cycle Length (s)	120	120	120	120	120	120	120	120	120	120	120	120
Volume Combined (vph)	0	1382	0	0	1076	0	0	778	0	0	699	0
Lane Utilization Factor	1.00	0.91	1.00	1.00	0.91	1.00	1.00	1.00	1.00	1.00	1.00	1.00
Turning Factor (vph)	0.95	0.99	0.85	0.95	0.98	0.85	0.95	0.98	0.85	0.95	0.98	0.85
Saturated Flow (vph)	0	6812	0	0	6735	0	0	1862	0	0	1855	0
Ped Intf Time (s)	0.0	0.0	0.0	0.0	0.0	0.0	0.0	0.0	0.0	0.0	0.0	0.0
Pedestrian Frequency (%)		0.00			0.00			0.00			0.00	
Protected Option Allowed		Yes			Yes			No			No	
Reference Time (s)	0.0	24.3	0.0	0.0	19.2	0.0			0.0			0.0
Adj Reference Time (s)	0.0	28.3	0.0	0.0	23.2	0.0			0.0			0.0
Permitted Option												
Adj Saturation A (vph)	0	1703		0	1684		0	1043		0	1661	
Reference Time A (s)	0.0	24.3		0.0	19.2		0.0	89.5		0.0	50.5	
Adj Saturation B (vph)	NA	NA		NA	NA		NA	NA		NA	NA	
Reference Time B (s)	NA	NA		NA	NA		NA	NA		NA	NA	
Reference Time (s)		24.3			19.2			89.5			50.5	
Adj Reference Time (s)		28.3			23.2			93.5			54.5	
Split Option												
Ref Time Combined (s)	0.0	24.3		0.0	19.2		0.0	50.1		0.0	45.2	
Ref Time Seperate (s)	0.0	22.3		0.0	16.1		7.6	38.3		2.7	36.2	
Reference Time (s)	24.3	24.3		19.2	19.2		50.1	50.1		45.2	45.2	
Adj Reference Time (s)	28.3	28.3		23.2	23.2		54.1	54.1		49.2	49.2	
Summary												
Protected Option (s)	28.3		NA									
Permitted Option (s)	28.3		93.5									
Split Option (s)	51.5		103.4									
Minimum (s)	28.3		93.5		121.8							
Right Turns												
Adj Reference Time (s)												
Cross Thru Ref Time (s)												
Oncoming Left Ref Time (s)												
Combined (s)												
Intersection Summary												
Intersection Capacity Utilization		101.5%		ICU Level of Service				G				
Reference Times and Phasing Options do not represent an optimized timing plan.												



Lane Group	NBT	SBT
Cycle Length (s)	90	90
Actual Green	38	38
Eff. Green	38	38
Opp. Eff. Green	38	38
Lanes	1	1
Opp. Lanes	1	1
Adj. LT Flow	125	45
Prop Left Turns	0.15	0.06
Prop LT Opp.	0.06	0.15
Adj. Opp. Flow	761	846
Total Lost Time	4.0	4.0
LTC	3.12	1.12
Volc	19.02	21.15
Rpo	1.00	1.00
gf	2.53	11.05
qro	0.58	0.58
gq	22.07	24.26
gu	15.93	13.74
n	10	7
PTHo	0.94	0.85
EL1	2.97	3.22
PL	0.15	0.06
fmin	0.06	0.06
fm		
EL2	7.59	4.41
Gdiff	19.53	13.20
fLT	0.65	0.90



Movement	EBL	EBT	EBR	WBL	WBT	WBR	NBL	NBT	NBR	SBL	SBT	SBR
Lane Configurations		TTT			TTT			TT			TT	
Traffic Volume (veh/h)	0	1263	119	0	904	172	115	598	65	41	560	98
Future Volume (veh/h)	0	1263	119	0	904	172	115	598	65	41	560	98
Initial Q (Qb), veh	0	0	0	0	0	0	0	0	0	0	0	0
Ped-Bike Adj(A_pbT)	1.00		1.00	1.00		1.00	1.00		1.00	1.00		1.00
Parking Bus, Adj	1.00	1.00	1.00	1.00	1.00	1.00	1.00	1.00	1.00	1.00	1.00	1.00
Work Zone On Approach		No			No			No			No	
Adj Sat Flow, veh/h/ln	0	1870	1870	0	1870	1870	1870	1870	1870	1870	1870	1870
Adj Flow Rate, veh/h	0	1373	129	0	983	187	125	650	71	45	609	107
Peak Hour Factor	0.92	0.92	0.92	0.92	0.92	0.92	0.92	0.92	0.92	0.92	0.92	0.92
Percent Heavy Veh, %	0	2	2	0	2	2	2	2	2	2	2	2
Cap, veh/h	0	2948	276	0	2680	503	99	361	38	68	571	97
Arrive On Green	0.00	0.49	0.49	0.00	0.49	0.49	0.42	0.42	0.42	0.42	0.42	0.42
Sat Flow, veh/h	0	6291	565	0	5744	1028	126	856	90	60	1351	231
Grp Volume(v), veh/h	0	1098	404	0	864	306	846	0	0	761	0	0
Grp Sat Flow(s),veh/h/ln	0	1609	1769	0	1609	1685	1072	0	0	1642	0	0
Q Serve(g_s), s	0.0	13.6	13.6	0.0	10.0	10.2	0.0	0.0	0.0	0.0	0.0	0.0
Cycle Q Clear(g_c), s	0.0	13.6	13.6	0.0	10.0	10.2	38.0	0.0	0.0	38.0	0.0	0.0
Prop In Lane	0.00		0.32	0.00		0.61	0.15		0.08	0.06		0.14
Lane Grp Cap(c), veh/h	0	2359	865	0	2359	824	498	0	0	736	0	0
V/C Ratio(X)	0.00	0.47	0.47	0.00	0.37	0.37	1.70	0.00	0.00	1.03	0.00	0.00
Avail Cap(c_a), veh/h	0	2359	865	0	2359	824	498	0	0	736	0	0
HCM Platoon Ratio	1.00	1.00	1.00	1.00	1.00	1.00	1.00	1.00	1.00	1.00	1.00	1.00
Upstream Filter(I)	0.00	1.00	1.00	0.00	1.00	1.00	1.00	0.00	0.00	1.00	0.00	0.00
Uniform Delay (d), s/veh	0.0	15.2	15.2	0.0	14.3	14.4	26.3	0.0	0.0	26.4	0.0	0.0
Incr Delay (d2), s/veh	0.0	0.7	1.8	0.0	0.4	1.3	322.3	0.0	0.0	42.3	0.0	0.0
Initial Q Delay(d3),s/veh	0.0	0.0	0.0	0.0	0.0	0.0	0.0	0.0	0.0	0.0	0.0	0.0
%ile BackOfQ(50%),veh/ln	0.0	1.2	1.6	0.0	0.9	1.1	47.5	0.0	0.0	13.4	0.0	0.0
Unsig. Movement Delay, s/veh												
LnGrp Delay(d),s/veh	0.0	15.9	17.0	0.0	14.8	15.7	348.6	0.0	0.0	68.7	0.0	0.0
LnGrp LOS	A	B	B	A	B	B	F	A	A	F	A	A
Approach Vol, veh/h		1502			1170			846			761	
Approach Delay, s/veh		16.2			15.0			348.6			68.7	
Approach LOS		B			B			F			E	
Timer - Assigned Phs		2		4		6		8				
Phs Duration (G+Y+Rc), s		42.0		48.0		42.0		48.0				
Change Period (Y+Rc), s		4.0		4.0		4.0		4.0				
Max Green Setting (Gmax), s		38.0		44.0		38.0		44.0				
Max Q Clear Time (g_c+I1), s		40.0		15.6		40.0		12.2				
Green Ext Time (p_c), s		0.0		15.1		0.0		11.8				
Intersection Summary												
HCM 6th Ctrl Delay				90.9								
HCM 6th LOS				F								



Movement	EBL	EBT	EBR	WBL	WBT	WBR	NBL	NBT	NBR	SBL	SBT	SBR
Lane Configurations		↑↑↑			↑↑↑			↕			↕	
Traffic Volume (veh/h)	0	1263	119	0	904	172	115	598	65	41	560	98
Future Volume (veh/h)	0	1263	119	0	904	172	115	598	65	41	560	98
Number	7	4	14	3	8	18	5	2	12	1	6	16
Initial Q, veh	0	0	0	0	0	0	0	0	0	0	0	0
Ped-Bike Adj (A_pbT)	1.00		1.00	1.00		1.00	1.00		1.00	1.00		1.00
Parking Bus Adj	1.00	1.00	1.00	1.00	1.00	1.00	1.00	1.00	1.00	1.00	1.00	1.00
Work Zone On Approach		No			No			No			No	
Lanes Open During Work Zone												
Adj Sat Flow, veh/h/ln	0	1870	1870	0	1870	1870	1870	1870	1870	1870	1870	1870
Adj Flow Rate, veh/h	0	1373	129	0	983	187	125	650	71	45	609	107
Peak Hour Factor	0.92	0.92	0.92	0.92	0.92	0.92	0.92	0.92	0.92	0.92	0.92	0.92
Percent Heavy Veh, %	0	2	2	0	2	2	2	2	2	2	2	2
Opposing Right Turn Influence	No			No			Yes			Yes		
Cap, veh/h	0	2948	276	0	2680	503	99	361	38	68	571	97
HCM Platoon Ratio	1.00	1.00	1.00	1.00	1.00	1.00	1.00	1.00	1.00	1.00	1.00	1.00
Prop Arrive On Green	0.00	0.49	0.49	0.00	0.49	0.49	0.42	0.42	0.42	0.42	0.42	0.42
Unsig. Movement Delay												
Ln Grp Delay, s/veh	0.0	15.9	17.0	0.0	14.8	15.7	348.6	0.0	0.0	68.7	0.0	0.0
Ln Grp LOS	A	B	B	A	B	B	F	A	A	F	A	A
Approach Vol, veh/h		1502			1170			846			761	
Approach Delay, s/veh		16.2			15.0			348.6			68.7	
Approach LOS		B			B			F			E	
Timer:		1	2	3	4	5	6	7	8			
Assigned Phs			2		4		6		8			
Case No			8.0		8.0		8.0		8.0			
Phs Duration (G+Y+Rc), s			42.0		48.0		42.0		48.0			
Change Period (Y+Rc), s			4.0		4.0		4.0		4.0			
Max Green (Gmax), s			38.0		44.0		38.0		44.0			
Max Allow Headway (MAH), s			6.1		5.8		5.9		5.8			
Max Q Clear (g_c+I1), s			40.0		15.6		40.0		12.2			
Green Ext Time (g_e), s			0.0		15.1		0.0		11.8			
Prob of Phs Call (p_c)			1.00		1.00		1.00		1.00			
Prob of Max Out (p_x)			0.00		0.00		0.00		0.00			
Left-Turn Movement Data												
Assigned Mvmt			5		7		1		3			
Mvmt Sat Flow, veh/h			126		0		60		0			
Through Movement Data												
Assigned Mvmt			2		4		6		8			
Mvmt Sat Flow, veh/h			856		6291		1351		5744			
Right-Turn Movement Data												
Assigned Mvmt			12		14		16		18			
Mvmt Sat Flow, veh/h			90		565		231		1028			
Left Lane Group Data												
Assigned Mvmt		0	5	0	7	0	1	0	3			
Lane Assignment			L+T+R		L+T+R		L+T+R					



Lanes in Grp	0	1	0	0	0	1	0	0
Grp Vol (v), veh/h	0	846	0	0	0	761	0	0
Grp Sat Flow (s), veh/h/ln	0	1072	0	0	0	1642	0	0
Q Serve Time (g_s), s	0.0	0.0	0.0	0.0	0.0	0.0	0.0	0.0
Cycle Q Clear Time (g_c), s	0.0	38.0	0.0	0.0	0.0	38.0	0.0	0.0
Perm LT Sat Flow (s_l), veh/h/ln	0	747	0	0	0	743	0	0
Shared LT Sat Flow (s_sh), veh/h/ln	0	968	0	0	0	1547	0	0
Perm LT Eff Green (g_p), s	0.0	38.0	0.0	0.0	0.0	38.0	0.0	0.0
Perm LT Serve Time (g_u), s	0.0	0.0	0.0	0.0	0.0	0.0	0.0	0.0
Perm LT Q Serve Time (g_ps), s	0.0	0.0	0.0	0.0	0.0	0.0	0.0	0.0
Time to First Blk (g_f), s	0.0	4.5	0.0	44.0	0.0	13.1	0.0	44.0
Serve Time pre Blk (g_fs), s	0.0	4.5	0.0	0.0	0.0	13.1	0.0	0.0
Prop LT Inside Lane (P_L)	0.00	0.15	0.00	0.00	0.00	0.06	0.00	0.00
Lane Grp Cap (c), veh/h	0	498	0	0	0	736	0	0
V/C Ratio (X)	0.00	1.70	0.00	0.00	0.00	1.03	0.00	0.00
Avail Cap (c_a), veh/h	0	498	0	0	0	736	0	0
Upstream Filter (I)	0.00	1.00	0.00	0.00	0.00	1.00	0.00	0.00
Uniform Delay (d1), s/veh	0.0	26.3	0.0	0.0	0.0	26.4	0.0	0.0
Incr Delay (d2), s/veh	0.0	322.3	0.0	0.0	0.0	42.3	0.0	0.0
Initial Q Delay (d3), s/veh	0.0	0.0	0.0	0.0	0.0	0.0	0.0	0.0
Control Delay (d), s/veh	0.0	348.6	0.0	0.0	0.0	68.7	0.0	0.0
1st-Term Q (Q1), veh/ln	0.0	2.8	0.0	0.0	0.0	4.8	0.0	0.0
2nd-Term Q (Q2), veh/ln	0.0	44.6	0.0	0.0	0.0	8.7	0.0	0.0
3rd-Term Q (Q3), veh/ln	0.0	0.0	0.0	0.0	0.0	0.0	0.0	0.0
%ile Back of Q Factor (f_B%)	0.00	1.00	0.00	1.00	0.00	1.00	0.00	1.00
%ile Back of Q (50%), veh/ln	0.0	47.5	0.0	0.0	0.0	13.4	0.0	0.0
%ile Storage Ratio (RQ%)	0.00	85.73	0.00	0.00	0.00	17.03	0.00	0.00
Initial Q (Qb), veh	0.0	0.0	0.0	0.0	0.0	0.0	0.0	0.0
Final (Residual) Q (Qe), veh	0.0	86.9	0.0	0.0	0.0	6.3	0.0	0.0
Sat Delay (ds), s/veh	0.0	0.0	0.0	0.0	0.0	0.0	0.0	0.0
Sat Q (Qs), veh	0.0	0.0	0.0	0.0	0.0	0.0	0.0	0.0
Sat Cap (cs), veh/h	0	0	0	0	0	0	0	0
Initial Q Clear Time (tc), h	0.0	0.4	0.0	0.0	0.0	0.3	0.0	0.0

Middle Lane Group Data

Assigned Mvmt	0	2	0	4	0	6	0	8
Lane Assignment				T				T
Lanes in Grp	0	0	0	3	0	0	0	3
Grp Vol (v), veh/h	0	0	0	1098	0	0	0	864
Grp Sat Flow (s), veh/h/ln	0	0	0	1609	0	0	0	1609
Q Serve Time (g_s), s	0.0	0.0	0.0	13.6	0.0	0.0	0.0	10.0
Cycle Q Clear Time (g_c), s	0.0	0.0	0.0	13.6	0.0	0.0	0.0	10.0
Lane Grp Cap (c), veh/h	0	0	0	2359	0	0	0	2359
V/C Ratio (X)	0.00	0.00	0.00	0.47	0.00	0.00	0.00	0.37
Avail Cap (c_a), veh/h	0	0	0	2359	0	0	0	2359
Upstream Filter (I)	0.00	0.00	0.00	1.00	0.00	0.00	0.00	1.00
Uniform Delay (d1), s/veh	0.0	0.0	0.0	15.2	0.0	0.0	0.0	14.3
Incr Delay (d2), s/veh	0.0	0.0	0.0	0.7	0.0	0.0	0.0	0.4
Initial Q Delay (d3), s/veh	0.0	0.0	0.0	0.0	0.0	0.0	0.0	0.0
Control Delay (d), s/veh	0.0	0.0	0.0	15.9	0.0	0.0	0.0	14.8
1st-Term Q (Q1), veh/ln	0.0	0.0	0.0	1.0	0.0	0.0	0.0	0.8
2nd-Term Q (Q2), veh/ln	0.0	0.0	0.0	0.1	0.0	0.0	0.0	0.1



3rd-Term Q (Q3), veh/ln	0.0	0.0	0.0	0.0	0.0	0.0	0.0	0.0
%ile Back of Q Factor (f_B%)	0.00	1.00	0.00	1.00	0.00	1.00	0.00	1.00
%ile Back of Q (50%), veh/ln	0.0	0.0	0.0	1.2	0.0	0.0	0.0	0.9
%ile Storage Ratio (RQ%)	0.00	0.00	0.00	0.57	0.00	0.00	0.00	0.33
Initial Q (Qb), veh	0.0	0.0	0.0	0.0	0.0	0.0	0.0	0.0
Final (Residual) Q (Qe), veh	0.0	0.0	0.0	0.0	0.0	0.0	0.0	0.0
Sat Delay (ds), s/veh	0.0	0.0	0.0	0.0	0.0	0.0	0.0	0.0
Sat Q (Qs), veh	0.0	0.0	0.0	0.0	0.0	0.0	0.0	0.0
Sat Cap (cs), veh/h	0	0	0	0	0	0	0	0
Initial Q Clear Time (tc), h	0.0	0.0	0.0	0.0	0.0	0.0	0.0	0.0

Right Lane Group Data

Assigned Mvmt	0	12	0	14	0	16	0	18
Lane Assignment				T+R				T+R
Lanes in Grp	0	0	0	1	0	0	0	1
Grp Vol (v), veh/h	0	0	0	404	0	0	0	306
Grp Sat Flow (s), veh/h/ln	0	0	0	1769	0	0	0	1685
Q Serve Time (g_s), s	0.0	0.0	0.0	13.6	0.0	0.0	0.0	10.2
Cycle Q Clear Time (g_c), s	0.0	0.0	0.0	13.6	0.0	0.0	0.0	10.2
Prot RT Sat Flow (s_R), veh/h/ln	0.0	0.0	0.0	0.0	0.0	0.0	0.0	0.0
Prot RT Eff Green (g_R), s	0.0	0.0	0.0	0.0	0.0	0.0	0.0	0.0
Prop RT Outside Lane (P_R)	0.00	0.08	0.00	0.32	0.00	0.14	0.00	0.61

Lane Grp Cap (c), veh/h	0	0	0	865	0	0	0	824
V/C Ratio (X)	0.00	0.00	0.00	0.47	0.00	0.00	0.00	0.37
Avail Cap (c_a), veh/h	0	0	0	865	0	0	0	824
Upstream Filter (I)	0.00	0.00	0.00	1.00	0.00	0.00	0.00	1.00
Uniform Delay (d1), s/veh	0.0	0.0	0.0	15.2	0.0	0.0	0.0	14.4
Incr Delay (d2), s/veh	0.0	0.0	0.0	1.8	0.0	0.0	0.0	1.3
Initial Q Delay (d3), s/veh	0.0	0.0	0.0	0.0	0.0	0.0	0.0	0.0
Control Delay (d), s/veh	0.0	0.0	0.0	17.0	0.0	0.0	0.0	15.7
1st-Term Q (Q1), veh/ln	0.0	0.0	0.0	1.1	0.0	0.0	0.0	0.8
2nd-Term Q (Q2), veh/ln	0.0	0.0	0.0	0.4	0.0	0.0	0.0	0.3
3rd-Term Q (Q3), veh/ln	0.0	0.0	0.0	0.0	0.0	0.0	0.0	0.0
%ile Back of Q Factor (f_B%)	0.00	1.00	0.00	1.00	0.00	1.00	0.00	1.00
%ile Back of Q (50%), veh/ln	0.0	0.0	0.0	1.6	0.0	0.0	0.0	1.1
%ile Storage Ratio (RQ%)	0.00	0.00	0.00	0.75	0.00	0.00	0.00	0.43
Initial Q (Qb), veh	0.0	0.0	0.0	0.0	0.0	0.0	0.0	0.0
Final (Residual) Q (Qe), veh	0.0	0.0	0.0	0.0	0.0	0.0	0.0	0.0
Sat Delay (ds), s/veh	0.0	0.0	0.0	0.0	0.0	0.0	0.0	0.0
Sat Q (Qs), veh	0.0	0.0	0.0	0.0	0.0	0.0	0.0	0.0
Sat Cap (cs), veh/h	0	0	0	0	0	0	0	0
Initial Q Clear Time (tc), h	0.0	0.0	0.0	0.0	0.0	0.0	0.0	0.0

Intersection Summary

HCM 6th Ctrl Delay	90.9
HCM 6th LOS	F



Approach	EB	WB	NB	SB
Crosswalk Length (m)	9.72	9.70	2.19	2.20
Crosswalk Width (m)	1.20	1.20	1.20	1.20
Total Number of Lanes Crossed	8	8	2	2
Number of Right-Turn Islands	0	0	0	0
Type of Control	None	None	None	None
Corresponding Signal Phase	6	2	4	8
Effective Walk Time (s)	0.0	0.0	0.0	0.0
Right Corner Size A (m)	2.74	2.74	2.74	2.74
Right Corner Size B (m)	2.74	2.74	2.74	2.74
Right Corner Curb Radius (m)	0.00	0.00	0.00	0.00
Right Corner Total Area (sq.m)	7.51	7.51	7.51	7.51
Ped. Left-Right Flow Rate (p/h)	0	0	0	0
Ped. Right-Left Flow Rate (p/h)	0	0	0	0
Ped. R. Sidewalk Flow Rate (p/h)	0	0	0	0
Veh. Perm. L. Flow in Walk (v/h)	0	0	0	0
Veh. Perm. R. Flow in Walk (v/h)	0	0	0	0
Veh. RTOR Flow in Walk (v/h)	0	0	0	0
85th percentile speed (km/h)	50	50	50	50
Right Corner Area per Ped (sq.m)	0.0	0.0	0.0	0.0
Right Corner Quality of Service	-	-	-	-
Ped. Circulation Area (sq.m)	0.0	0.0	0.0	0.0
Crosswalk Circulation Code	-	-	-	-
Pedestrian Delay (s/p)	45.0	45.0	45.0	45.0
Pedestrian Compliance Code	Poor	Poor	Poor	Poor
Pedestrian Crosswalk Score	3.08	3.07	2.52	2.53
Pedestrian Crosswalk LOS	C	C	C	C



Approach	EB	WB	NB	SB
Bicycle Flow Rate (bike/h)	0	0	0	0
Total Flow Rate (veh/h)	1502	1170	846	761
Effct. Green for Bike (s)	44.0	44.0	38.0	38.0
Cross Street Width (m)	7.20	7.21	31.82	31.88
Through Lanes Number	4	4	1	1
Through Lane Width (m)	3.60	3.60	3.60	3.60
Bicycle Lane Width (m)	0.00	0.00	0.00	0.00
Striped Parking Lane Width (m)	0.00	0.00	0.00	0.00
Paved Shoulder Width (m)	0.00	0.00	0.00	0.00
Curb Is Present?	No	No	No	No
On Street Parking?	No	No	No	No
Bicycle Lane Capacity (bike/h)	978	978	844	844
Bicycle Delay (s/bike)	11.8	11.8	15.0	15.0
Bicycle Compliance	Fair	Fair	Fair	Fair
Bicycle LOS Score	2.58	2.44	4.59	4.46
Bicycle LOS	C	B	E	D



Lane Group	EBL	EBT	EBR	WBL	WBT	WBR	NBL	NBT	NBR	SBL	SBT	SBR
Lane Configurations		↑↑	↑↑		↑↑	↑		↑↑			↑↑	
Traffic Volume (vph)	103	84	1141	52	453	294	533	765	158	37	717	90
Future Volume (vph)	103	84	1141	52	453	294	533	765	158	37	717	90
Ideal Flow (vphpl)	1900	1900	1900	1900	1900	1900	1900	1900	1900	1900	1900	1900
Storage Length (m)	0.0		0.0	0.0		50.0	0.0		0.0	0.0		0.0
Storage Lanes	0		2	0		1	0		0	0		0
Taper Length (m)	7.5			7.5			7.5			7.5		
Lane Util. Factor	0.95	0.95	0.88	0.95	0.95	1.00	0.95	0.95	0.95	0.95	0.95	0.95
Frnt			0.850			0.850		0.984			0.984	
Flt Protected		0.973			0.995			0.982			0.998	
Satd. Flow (prot)	0	3444	2787	0	3522	1583	0	3420	0	0	3476	0
Flt Permitted		0.660			0.907			0.590			0.635	
Satd. Flow (perm)	0	2336	2787	0	3210	1583	0	2055	0	0	2211	0
Right Turn on Red			Yes			Yes			Yes			Yes
Satd. Flow (RTOR)			144			68		39			38	
Link Speed (k/h)		50			50			50			50	
Link Distance (m)		663.1			282.5			259.9			282.7	
Travel Time (s)		47.7			20.3			18.7			20.4	
Peak Hour Factor	0.92	0.92	0.92	0.92	0.92	0.92	0.92	0.92	0.92	0.92	0.92	0.92
Adj. Flow (vph)	112	91	1240	57	492	320	579	832	172	40	779	98
Shared Lane Traffic (%)												
Lane Group Flow (vph)	0	203	1240	0	549	320	0	1583	0	0	917	0
Enter Blocked Intersection	No	No	No	No	No	No	No	No	No	No	No	No
Lane Alignment	Left	Left	Right	Left	Left	Right	Left	Left	Right	Left	Left	Right
Median Width(m)		3.0			10.0			3.0			3.0	
Link Offset(m)		0.0			0.0			0.0			0.0	
Crosswalk Width(m)		4.8			4.8			4.8			4.8	
Two way Left Turn Lane												
Headway Factor	1.00	1.00	1.00	1.00	1.00	1.00	1.00	1.00	1.00	1.00	1.00	1.00
Turning Speed (k/h)	25		15	25		15	25		15	25		15
Turn Type	Perm	NA	Perm	Perm	NA	Perm	Perm	NA		Perm	NA	
Protected Phases		4			8			2			6	
Permitted Phases	4		4	8		8	2			6		
Minimum Split (s)	20.0	20.0	20.0	20.0	20.0	20.0	20.0	20.0		20.0	20.0	
Total Split (s)	20.0	20.0	20.0	20.0	20.0	20.0	20.0	20.0		20.0	20.0	
Total Split (%)	50.0%	50.0%	50.0%	50.0%	50.0%	50.0%	50.0%	50.0%		50.0%	50.0%	
Maximum Green (s)	16.0	16.0	16.0	16.0	16.0	16.0	16.0	16.0		16.0	16.0	
Yellow Time (s)	3.5	3.5	3.5	3.5	3.5	3.5	3.5	3.5		3.5	3.5	
All-Red Time (s)	0.5	0.5	0.5	0.5	0.5	0.5	0.5	0.5		0.5	0.5	
Lost Time Adjust (s)		0.0	0.0		0.0	0.0		0.0			0.0	
Total Lost Time (s)		4.0	4.0		4.0	4.0		4.0			4.0	
Lead/Lag												
Lead-Lag Optimize?												
Walk Time (s)	5.0	5.0	5.0	5.0	5.0	5.0	5.0	5.0		5.0	5.0	
Flash Dont Walk (s)	11.0	11.0	11.0	11.0	11.0	11.0	11.0	11.0		11.0	11.0	
Pedestrian Calls (#/hr)	0	0	0	0	0	0	0	0		0	0	
Act Effct Green (s)		16.0	16.0		16.0	16.0		16.0			16.0	
Actuated g/C Ratio		0.40	0.40		0.40	0.40		0.40			0.40	
v/c Ratio		0.22	1.03		0.43	0.47		2.77dl			1.01	



Lane Group	EBL	EBT	EBR	WBL	WBT	WBR	NBL	NBT	NBR	SBL	SBT	SBR
Control Delay		8.7	50.0		10.0	9.8		415.7			49.2	
Queue Delay		0.0	0.0		0.0	0.0		0.0			0.0	
Total Delay		8.7	50.0		10.0	9.8		415.7			49.2	
LOS		A	D		A	A		F			D	
Approach Delay		44.2			9.9			415.7			49.2	
Approach LOS		D			A			F			D	
Stops (vph)		111	808		332	163		1327			632	
Fuel Used(l)		16	134		25	14		531			69	
CO Emissions (g/hr)		289	2490		463	256		9886			1279	
NOx Emissions (g/hr)		56	481		89	49		1908			247	
VOC Emissions (g/hr)		67	574		107	59		2280			295	
Dilemma Vehicles (#)		0	0		0	0		0			0	
Queue Length 50th (m)		4.6	~46.5		13.9	12.0		~100.1			~32.0	
Queue Length 95th (m)		9.6	#89.6		23.3	27.2		#135.8			#67.7	
Internal Link Dist (m)		639.1			258.5			235.9			258.7	
Turn Bay Length (m)						50.0						
Base Capacity (vph)		934	1201		1284	674		845			907	
Starvation Cap Reductn		0	0		0	0		0			0	
Spillback Cap Reductn		0	0		0	0		0			0	
Storage Cap Reductn		0	0		0	0		0			0	
Reduced v/c Ratio		0.22	1.03		0.43	0.47		1.87			1.01	

Intersection Summary

Area Type: Other
 Cycle Length: 40
 Actuated Cycle Length: 40
 Offset: 0 (0%), Referenced to phase 2:NBTL and 6:SBTL, Start of Green
 Natural Cycle: 120
 Control Type: Pretimed
 Maximum v/c Ratio: 1.87
 Intersection Signal Delay: 161.2 Intersection LOS: F
 Intersection Capacity Utilization 98.5% ICU Level of Service F
 Analysis Period (min) 15
 ~ Volume exceeds capacity, queue is theoretically infinite.
 Queue shown is maximum after two cycles.
 # 95th percentile volume exceeds capacity, queue may be longer.
 Queue shown is maximum after two cycles.
 dl Defacto Left Lane. Recode with 1 though lane as a left lane.

Splits and Phases: 11: Av. Velasco / AV. QOSQO & AV. 28 DE JULIO / VIA EXPRESA

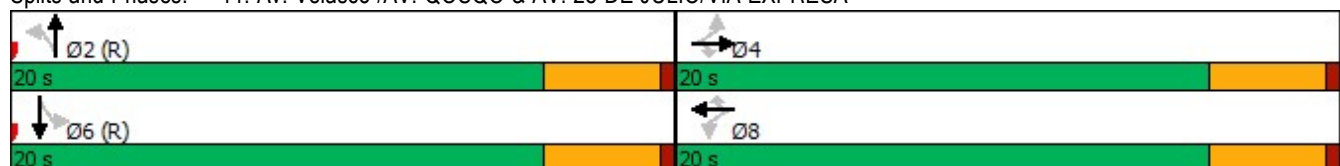



TT. AV. VELASCO / AV. QOSQO & AV. 28 DE JULIO / VIA EXPRESA

10/11/2021



Lane Group	EBL	EBT	EBR	WBL	WBT	WBR	NBL	NBT	NBR	SBL	SBT	SBR
Lane Configurations		↕↕	↗↗		↕↕	↗		↕↕			↕↕	
Ideal Flow (vphpl)	1900	1900	1900	1900	1900	1900	1900	1900	1900	1900	1900	1900
Lane Width (m)	3.6	3.6	3.6	3.6	3.6	3.6	3.6	3.6	3.6	3.6	3.6	3.6
Grade (%)		0%			0%			0%				0%
Storage Length (m)	0.0		0.0	0.0		50.0	0.0		0.0	0.0		0.0
Storage Lanes	0		2	0		1	0		0	0		0
Taper Length (m)	7.5			7.5			7.5			7.5		
Lane Util. Factor	0.95	0.95	0.88	0.95	0.95	1.00	0.95	0.95	0.95	0.95	0.95	0.95
Ped Bike Factor												
Frt			0.850			0.850		0.984				0.984
Flt Protected		0.973			0.995			0.982				0.998
Satd. Flow (prot)	0	3444	2787	0	3522	1583	0	3420	0	0	3476	0
Flt Permitted		0.660			0.907			0.590				0.635
Satd. Flow (perm)	0	2336	2787	0	3210	1583	0	2055	0	0	2211	0
Right Turn on Red			Yes			Yes			Yes			Yes
Satd. Flow (RTOR)			144			68		39				38
Link Speed (k/h)		50			50			50				50
Link Distance (m)		663.1			282.5			259.9				282.7
Travel Time (s)		47.7			20.3			18.7				20.4

Intersection Summary

Area Type: Other



Lane Group	EBL	EBT	EBR	WBL	WBT	WBR	NBL	NBT	NBR	SBL	SBT	SBR
Traffic Volume (vph)	103	84	1141	52	453	294	533	765	158	37	717	90
Future Volume (vph)	103	84	1141	52	453	294	533	765	158	37	717	90
Confl. Peds. (#/hr)												
Confl. Bikes (#/hr)												
Peak Hour Factor	0.92	0.92	0.92	0.92	0.92	0.92	0.92	0.92	0.92	0.92	0.92	0.92
Growth Factor	100%	100%	100%	100%	100%	100%	100%	100%	100%	100%	100%	100%
Heavy Vehicles (%)	2%	2%	2%	2%	2%	2%	2%	2%	2%	2%	2%	2%
Bus Blockages (#/hr)	0	0	0	0	0	0	0	0	0	0	0	0
Parking (#/hr)												
Mid-Block Traffic (%)		0%			0%			0%			0%	
Adj. Flow (vph)	112	91	1240	57	492	320	579	832	172	40	779	98
Shared Lane Traffic (%)												
Lane Group Flow (vph)	0	203	1240	0	549	320	0	1583	0	0	917	0

Intersection Summary

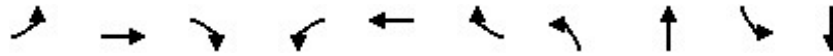

Lane Group	EBL	EBT	EBR	WBL	WBT	WBR	NBL	NBT	SBL	SBT
Lane Configurations		↕↕	↗↗		↕↕	↗		↕↕		↕↕
Future Volume (vph)	103	84	1141	52	453	294	533	765	37	717
Turn Type	Perm	NA	Perm	Perm	NA	Perm	Perm	NA	Perm	NA
Protected Phases		4			8			2		6
Permitted Phases	4		4	8		8	2		6	
Detector Phase	4	4	4	8	8	8	2	2	6	6
Switch Phase										
Minimum Initial (s)	4.0	4.0	4.0	4.0	4.0	4.0	4.0	4.0	4.0	4.0
Minimum Split (s)	20.0	20.0	20.0	20.0	20.0	20.0	20.0	20.0	20.0	20.0
Total Split (s)	20.0	20.0	20.0	20.0	20.0	20.0	20.0	20.0	20.0	20.0
Total Split (%)	50.0%	50.0%	50.0%	50.0%	50.0%	50.0%	50.0%	50.0%	50.0%	50.0%
Yellow Time (s)	3.5	3.5	3.5	3.5	3.5	3.5	3.5	3.5	3.5	3.5
All-Red Time (s)	0.5	0.5	0.5	0.5	0.5	0.5	0.5	0.5	0.5	0.5
Lost Time Adjust (s)		0.0	0.0		0.0	0.0		0.0		0.0
Total Lost Time (s)		4.0	4.0		4.0	4.0		4.0		4.0
Lead/Lag										
Lead-Lag Optimize?										
Recall Mode	Max	Max	Max	Max	Max	Max	Max	Max	Max	Max
Act Effct Green (s)		16.0	16.0		16.0	16.0		16.0		16.0
Actuated g/C Ratio		0.40	0.40		0.40	0.40		0.40		0.40
v/c Ratio		0.22	1.03		0.43	0.47		2.77dl		1.01
Control Delay		8.7	50.0		10.0	9.8		415.7		49.2
Queue Delay		0.0	0.0		0.0	0.0		0.0		0.0
Total Delay		8.7	50.0		10.0	9.8		415.7		49.2
LOS		A	D		A	A		F		D
Approach Delay		44.2			9.9			415.7		49.2
Approach LOS		D			A			F		D

Intersection Summary

Cycle Length: 40
 Actuated Cycle Length: 40
 Offset: 0 (0%), Referenced to phase 2:NBT and 6:SBTL Start of Green
 Natural Cycle: 120
 Control Type: Pretimed
 Maximum v/c Ratio: 1.87
 Intersection Signal Delay: 161.2 Intersection LOS: F
 Intersection Capacity Utilization 98.5% ICU Level of Service F
 Analysis Period (min) 15
 dl Defacto Left Lane. Recode with 1 though lane as a left lane.

Splits and Phases: 11: Av. Velasco / AV. QOSQO & AV. 28 DE JULIO / VIA EXPRESA

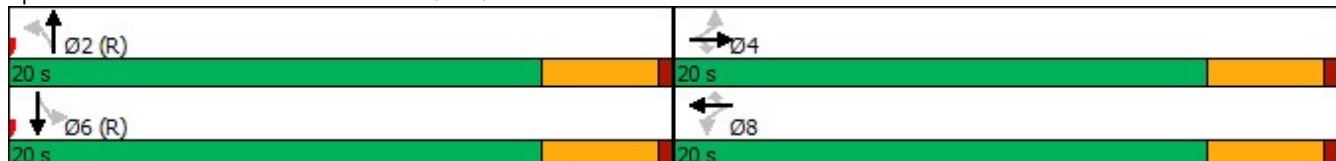

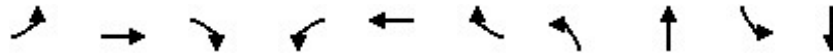

Lane Group	EBL	EBT	EBR	WBL	WBT	WBR	NBL	NBT	SBL	SBT
Protected Phases		4			8			2		6
Permitted Phases	4		4	8		8	2		6	
Minimum Initial (s)	4.0	4.0	4.0	4.0	4.0	4.0	4.0	4.0	4.0	4.0
Minimum Split (s)	20.0	20.0	20.0	20.0	20.0	20.0	20.0	20.0	20.0	20.0
Total Split (s)	20.0	20.0	20.0	20.0	20.0	20.0	20.0	20.0	20.0	20.0
Total Split (%)	50.0%	50.0%	50.0%	50.0%	50.0%	50.0%	50.0%	50.0%	50.0%	50.0%
Maximum Green (s)	16.0	16.0	16.0	16.0	16.0	16.0	16.0	16.0	16.0	16.0
Yellow Time (s)	3.5	3.5	3.5	3.5	3.5	3.5	3.5	3.5	3.5	3.5
All-Red Time (s)	0.5	0.5	0.5	0.5	0.5	0.5	0.5	0.5	0.5	0.5
Lead/Lag										
Lead-Lag Optimize?										
Vehicle Extension (s)	3.0	3.0	3.0	3.0	3.0	3.0	3.0	3.0	3.0	3.0
Minimum Gap (s)	3.0	3.0	3.0	3.0	3.0	3.0	3.0	3.0	3.0	3.0
Time Before Reduce (s)	0.0	0.0	0.0	0.0	0.0	0.0	0.0	0.0	0.0	0.0
Time To Reduce (s)	0.0	0.0	0.0	0.0	0.0	0.0	0.0	0.0	0.0	0.0
Recall Mode	Max	Max	Max	Max	Max	Max	Max	Max	Max	Max
Walk Time (s)	5.0	5.0	5.0	5.0	5.0	5.0	5.0	5.0	5.0	5.0
Flash Dont Walk (s)	11.0	11.0	11.0	11.0	11.0	11.0	11.0	11.0	11.0	11.0
Pedestrian Calls (#/hr)	0	0	0	0	0	0	0	0	0	0
90th %ile Green (s)	16.0	16.0	16.0	16.0	16.0	16.0	16.0	16.0	16.0	16.0
90th %ile Term Code	MaxR	MaxR	MaxR	MaxR	MaxR	MaxR	Coord	Coord	Coord	Coord
70th %ile Green (s)	16.0	16.0	16.0	16.0	16.0	16.0	16.0	16.0	16.0	16.0
70th %ile Term Code	MaxR	MaxR	MaxR	MaxR	MaxR	MaxR	Coord	Coord	Coord	Coord
50th %ile Green (s)	16.0	16.0	16.0	16.0	16.0	16.0	16.0	16.0	16.0	16.0
50th %ile Term Code	MaxR	MaxR	MaxR	MaxR	MaxR	MaxR	Coord	Coord	Coord	Coord
30th %ile Green (s)	16.0	16.0	16.0	16.0	16.0	16.0	16.0	16.0	16.0	16.0
30th %ile Term Code	MaxR	MaxR	MaxR	MaxR	MaxR	MaxR	Coord	Coord	Coord	Coord
10th %ile Green (s)	16.0	16.0	16.0	16.0	16.0	16.0	16.0	16.0	16.0	16.0
10th %ile Term Code	MaxR	MaxR	MaxR	MaxR	MaxR	MaxR	Coord	Coord	Coord	Coord

Intersection Summary

Cycle Length: 40
 Actuated Cycle Length: 40
 Offset: 0 (0%), Referenced to phase 2:NBTL and 6:SBTL, Start of Green
 Control Type: Pretimed

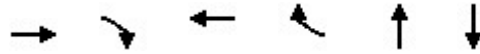

Lane Group	EBT	EBR	WBT	WBR	NBT	SBT
Lane Group Flow (vph)	203	1240	549	320	1583	917
v/c Ratio	0.22	1.03	0.43	0.47	2.77dl	1.01
Control Delay	8.7	50.0	10.0	9.8	415.7	49.2
Queue Delay	0.0	0.0	0.0	0.0	0.0	0.0
Total Delay	8.7	50.0	10.0	9.8	415.7	49.2
Queue Length 50th (m)	4.6	~46.5	13.9	12.0	~100.1	~32.0
Queue Length 95th (m)	9.6	#89.6	23.3	27.2	#135.8	#67.7
Internal Link Dist (m)	639.1		258.5		235.9	258.7
Turn Bay Length (m)				50.0		
Base Capacity (vph)	934	1201	1284	674	845	907
Starvation Cap Reductn	0	0	0	0	0	0
Spillback Cap Reductn	0	0	0	0	0	0
Storage Cap Reductn	0	0	0	0	0	0
Reduced v/c Ratio	0.22	1.03	0.43	0.47	1.87	1.01

Intersection Summary

~ Volume exceeds capacity, queue is theoretically infinite.

Queue shown is maximum after two cycles.

95th percentile volume exceeds capacity, queue may be longer.

Queue shown is maximum after two cycles.

dl Defacto Left Lane. Recode with 1 though lane as a left lane.



Lane Group	EBL	EBT	EBR	WBL	WBT	WBR	NBL	NBT	NBR	SBL	SBT	SBR
Enter Blocked Intersection	No	No	No	No	No	No	No	No	No	No	No	No
Lane Alignment	Left	Left	Right	Left	Left	Right	Left	Left	Right	Left	Left	Right
Median Width(m)		3.0			10.0			3.0			3.0	
Link Offset(m)		0.0			0.0			0.0			0.0	
Crosswalk Width(m)		4.8			4.8			4.8			4.8	
Two way Left Turn Lane												
Headway Factor	1.00	1.00	1.00	1.00	1.00	1.00	1.00	1.00	1.00	1.00	1.00	1.00
Turning Speed (k/h)	25		15	25		15	25		15	25		15

Intersection Summary



Movement	EBL	EBT	EBR	WBL	WBT	WBR	NBL	NBT	NBR	SBL	SBT	SBR		
Lane Configurations		↕↕	↗↗		↕↕	↗		↕↕			↕↕			
Volume (vph)	103	84	1141	52	453	294	533	765	158	37	717	90		
Pedestrians														
Ped Button														
Pedestrian Timing (s)														
Free Right			No			No			No				No	
Ideal Flow	1900	1900	1900	1900	1900	1900	1900	1900	1900	1900	1900	1900		
Lost Time (s)	4.0	4.0	4.0	4.0	4.0	4.0	4.0	4.0	4.0	4.0	4.0	4.0		
Minimum Green (s)	4.0	4.0	4.0	4.0	4.0	4.0	4.0	4.0	4.0	4.0	4.0	4.0		
Refr Cycle Length (s)	120	120	120	120	120	120	120	120	120	120	120	120		
Volume Combined (vph)	0	187	1141	0	505	294	0	1456	0	0	844	0		
Lane Utilization Factor	1.00	0.95	0.89	1.00	0.95	1.00	1.00	0.95	1.00	1.00	0.95	1.00		
Turning Factor (vph)	0.95	0.97	0.85	0.95	0.99	0.85	0.95	0.97	0.85	0.95	0.98	0.85		
Saturated Flow (vph)	0	3518	2859	0	3599	1615	0	3494	0	0	3552	0		
Ped Intf Time (s)	0.0	0.0	0.0	0.0	0.0	0.0	0.0	0.0	0.0	0.0	0.0	0.0		
Pedestrian Frequency (%)	0.00				0.00				0.00		0.00			
Protected Option Allowed	No				No				No		No			
Reference Time (s)			47.9				21.8				0.0			
Adj Reference Time (s)			51.9				25.8				0.0			
Permitted Option														
Adj Saturation A (vph)	0	117			0	280			0	116			0	691
Reference Time A (s)	0.0	105.4			0.0	63.7			0.0	549.2			0.0	60.4
Adj Saturation B (vph)	NA	NA			0	1809			NA	NA			NA	NA
Reference Time B (s)	NA	NA			11.5	20.8			NA	NA			NA	NA
Reference Time (s)	105.4				20.8				549.2				60.4	
Adj Reference Time (s)	109.4				24.8				553.2				64.4	
Split Option														
Ref Time Combined (s)	0.0	6.4			0.0	16.8			0.0	50.0			0.0	28.5
Ref Time Seperate (s)	6.8	2.8			3.5	15.0			35.4	26.0			2.5	24.2
Reference Time (s)	6.8	6.8			16.8	16.8			50.0	50.0			28.5	28.5
Adj Reference Time (s)	10.8	10.8			20.8	20.8			54.0	54.0			32.5	32.5
Summary	EB WB		NB SB		Combined									
Protected Option (s)	NA		NA											
Permitted Option (s)	109.4		553.2											
Split Option (s)	31.7		86.5											
Minimum (s)	31.7		86.5		118.2									
Right Turns	EBR		WBR											
Adj Reference Time (s)	51.9		25.8											
Cross Thru Ref Time (s)	32.5		54.0											
Oncoming Left Ref Time (s)	20.8		10.8											
Combined (s)	105.3		90.7											
Intersection Summary														
Intersection Capacity Utilization			98.5%		ICU Level of Service				F					
Reference Times and Phasing Options do not represent an optimized timing plan.														

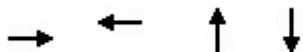

Lane Group	EBT	WBT	NBT	SBT
Cycle Length (s)	40	40	40	40
Actual Green	16	16	16	16
Eff. Green	16	16	16	16
Opp. Eff. Green	16	16	16	16
Lanes	2	2	2	2
Opp. Lanes	2	2	2	2
Adj. LT Flow	112	57	579	40
Prop Left Turns	0.55	0.10	0.37	0.04
Prop LT Opp.				
Adj. Opp. Flow	549	203	917	1583
Total Lost Time	4.0	4.0	4.0	4.0
LTC	1.24	0.63	6.43	0.44
Volc	3.21	1.19	5.36	9.26
Rpo	1.00	1.00	1.00	1.00
gf	1.70	4.47	0.00	5.77
qro	0.60	0.60	0.60	0.60
gq	0.59	0.00	4.79	16.00
gu	14.30	11.53	11.21	0.00
n				
PTHo				
EL1	2.48	1.72	3.61	7.01
PL	1.31	0.21	1.16	0.11
fmin	0.29	0.15	0.27	0.14
fm	0.41	0.90	0.27	0.36
EL2				
Gdiff				
fLT	0.66	0.91	0.59	0.64



Movement	EBL	EBT	EBR	WBL	WBT	WBR	NBL	NBT	NBR	SBL	SBT	SBR
Lane Configurations		↕↕	↗↗		↕↕	↗		↕↕			↕↕	
Traffic Volume (veh/h)	103	84	1141	52	453	294	533	765	158	37	717	90
Future Volume (veh/h)	103	84	1141	52	453	294	533	765	158	37	717	90
Initial Q (Qb), veh	0	0	0	0	0	0	0	0	0	0	0	0
Ped-Bike Adj(A_pbT)	1.00		1.00	1.00		1.00	1.00		1.00	1.00		1.00
Parking Bus, Adj	1.00	1.00	1.00	1.00	1.00	1.00	1.00	1.00	1.00	1.00	1.00	1.00
Work Zone On Approach		No			No			No			No	
Adj Sat Flow, veh/h/ln	1870	1870	1870	1870	1870	1870	1870	1870	1870	1870	1870	1870
Adj Flow Rate, veh/h	112	91	1240	57	492	320	579	832	172	40	779	98
Peak Hour Factor	0.92	0.92	0.92	0.92	0.92	0.92	0.92	0.92	0.92	0.92	0.92	0.92
Percent Heavy Veh, %	2	2	2	2	2	2	2	2	2	2	2	2
Cap, veh/h	279	836	1116	168	1133	634	281	550	119	98	874	144
Arrive On Green	0.40	0.40	0.40	0.40	0.40	0.40	0.40	0.40	0.40	0.40	0.40	0.40
Sat Flow, veh/h	348	2090	2790	144	2833	1585	270	1374	297	0	2186	360
Grp Volume(v), veh/h	203	0	1240	257	292	320	627	0	956	471	0	446
Grp Sat Flow(s),veh/h/ln	821	1617	1395	1360	1617	1585	292	0	1649	908	0	1637
Q Serve(g_s), s	3.9	0.0	16.0	0.0	5.3	6.1	7.0	0.0	16.0	0.0	0.0	9.0
Cycle Q Clear(g_c), s	9.2	0.0	16.0	3.8	5.3	6.1	16.0	0.0	16.0	16.0	0.0	9.0
Prop In Lane	0.55		1.00	0.22		1.00	0.92		0.18	0.08		0.22
Lane Grp Cap(c), veh/h	468	647	1116	654	647	634	290	0	659	461	0	655
V/C Ratio(X)	0.43	0.00	1.11	0.39	0.45	0.50	2.16	0.00	1.45	1.02	0.00	0.68
Avail Cap(c_a), veh/h	468	647	1116	654	647	634	290	0	659	461	0	655
HCM Platoon Ratio	1.00	1.00	1.00	1.00	1.00	1.00	1.00	1.00	1.00	1.00	1.00	1.00
Upstream Filter(I)	1.00	0.00	1.00	1.00	1.00	1.00	1.00	0.00	1.00	1.00	0.00	1.00
Uniform Delay (d), s/veh	9.8	0.0	12.0	8.3	8.8	9.0	18.6	0.0	12.0	10.5	0.0	9.9
Incr Delay (d2), s/veh	2.9	0.0	62.9	1.8	2.3	2.9	534.3	0.0	210.8	47.6	0.0	5.6
Initial Q Delay(d3),s/veh	0.0	0.0	0.0	0.0	0.0	0.0	0.0	0.0	0.0	0.0	0.0	0.0
%ile BackOfQ(50%),veh/ln	0.4	0.0	9.7	0.3	0.4	0.5	43.0	0.0	38.6	6.1	0.0	1.0
Unsig. Movement Delay, s/veh												
LnGrp Delay(d),s/veh	12.7	0.0	74.9	10.1	11.1	11.9	552.9	0.0	222.8	58.0	0.0	15.5
LnGrp LOS	B	A	F	B	B	B	F	A	F	F	A	B
Approach Vol, veh/h		1443			869			1583				917
Approach Delay, s/veh		66.1			11.1			353.6				37.4
Approach LOS		E			B			F				D
Timer - Assigned Phs		2		4		6		8				
Phs Duration (G+Y+Rc), s		20.0		20.0		20.0		20.0				
Change Period (Y+Rc), s		4.0		4.0		4.0		4.0				
Max Green Setting (Gmax), s		16.0		16.0		16.0		16.0				
Max Q Clear Time (g_c+I1), s		18.0		18.0		18.0		8.1				
Green Ext Time (p_c), s		0.0		0.0		0.0		3.7				
Intersection Summary												
HCM 6th Ctrl Delay			145.3									
HCM 6th LOS			F									



Movement	EBL	EBT	EBR	WBL	WBT	WBR	NBL	NBT	NBR	SBL	SBT	SBR
Lane Configurations		↕↕	↗↗		↕↕	↗		↕↕			↕↕	
Traffic Volume (veh/h)	103	84	1141	52	453	294	533	765	158	37	717	90
Future Volume (veh/h)	103	84	1141	52	453	294	533	765	158	37	717	90
Number	7	4	14	3	8	18	5	2	12	1	6	16
Initial Q, veh	0	0	0	0	0	0	0	0	0	0	0	0
Ped-Bike Adj (A_pbT)	1.00		1.00	1.00		1.00	1.00		1.00	1.00		1.00
Parking Bus Adj	1.00	1.00	1.00	1.00	1.00	1.00	1.00	1.00	1.00	1.00	1.00	1.00
Work Zone On Approach		No			No			No			No	
Lanes Open During Work Zone												
Adj Sat Flow, veh/h/ln	1870	1870	1870	1870	1870	1870	1870	1870	1870	1870	1870	1870
Adj Flow Rate, veh/h	112	91	1240	57	492	320	579	832	172	40	779	98
Peak Hour Factor	0.92	0.92	0.92	0.92	0.92	0.92	0.92	0.92	0.92	0.92	0.92	0.92
Percent Heavy Veh, %	2	2	2	2	2	2	2	2	2	2	2	2
Opposing Right Turn Influence	Yes			Yes			Yes			Yes		
Cap, veh/h	279	836	1116	168	1133	634	281	550	119	98	874	144
HCM Platoon Ratio	1.00	1.00	1.00	1.00	1.00	1.00	1.00	1.00	1.00	1.00	1.00	1.00
Prop Arrive On Green	0.40	0.40	0.40	0.40	0.40	0.40	0.40	0.40	0.40	0.40	0.40	0.40
Unsig. Movement Delay												
Ln Grp Delay, s/veh	12.7	0.0	74.9	10.1	11.1	11.9	552.9	0.0	222.8	58.0	0.0	15.5
Ln Grp LOS	B	A	F	B	B	B	F	A	F	F	A	B
Approach Vol, veh/h		1443			869			1583			917	
Approach Delay, s/veh		66.1			11.1			353.6			37.4	
Approach LOS		E			B			F			D	
Timer:		1	2	3	4	5	6	7	8			
Assigned Phs			2		4		6		8			
Case No			8.0		7.0		8.0		7.0			
Phs Duration (G+Y+Rc), s			20.0		20.0		20.0		20.0			
Change Period (Y+Rc), s			4.0		4.0		4.0		4.0			
Max Green (Gmax), s			16.0		16.0		16.0		16.0			
Max Allow Headway (MAH), s			6.9		5.2		6.0		5.8			
Max Q Clear (g_c+I1), s			18.0		18.0		18.0		8.1			
Green Ext Time (g_e), s			0.0		0.0		0.0		3.7			
Prob of Phs Call (p_c)			1.00		1.00		1.00		1.00			
Prob of Max Out (p_x)			0.00		0.00		0.00		0.00			
Left-Turn Movement Data												
Assigned Mvmt			5		7		1		3			
Mvmt Sat Flow, veh/h			270		348		0		144			
Through Movement Data												
Assigned Mvmt			2		4		6		8			
Mvmt Sat Flow, veh/h			1374		2090		2186		2833			
Right-Turn Movement Data												
Assigned Mvmt			12		14		16		18			
Mvmt Sat Flow, veh/h			297		2790		360		1585			
Left Lane Group Data												
Assigned Mvmt		0	5	0	7	0	1	0	3			
Lane Assignment			L+T		L+T		L+T		L+T			



Lanes in Grp	0	1	0	1	0	1	0	1
Grp Vol (v), veh/h	0	627	0	203	0	471	0	257
Grp Sat Flow (s), veh/h/ln	0	292	0	821	0	908	0	1360
Q Serve Time (g_s), s	0.0	7.0	0.0	3.9	0.0	0.0	0.0	0.0
Cycle Q Clear Time (g_c), s	0.0	16.0	0.0	9.2	0.0	16.0	0.0	3.8
Perm LT Sat Flow (s_l), veh/h/ln	0	642	0	683	0	570	0	418
Shared LT Sat Flow (s_sh), veh/h/ln	0	0	0	0	0	0	0	0
Perm LT Eff Green (g_p), s	0.0	16.0	0.0	16.0	0.0	16.0	0.0	16.0
Perm LT Serve Time (g_u), s	0.0	7.0	0.0	10.7	0.0	0.0	0.0	16.0
Perm LT Q Serve Time (g_ps), s	0.0	7.0	0.0	3.9	0.0	0.0	0.0	0.0
Time to First Blk (g_f), s	0.0	0.0	0.0	1.6	0.0	7.8	0.0	6.1
Serve Time pre Blk (g_fs), s	0.0	0.0	0.0	1.6	0.0	7.8	0.0	3.8
Prop LT Inside Lane (P_L)	0.00	0.92	0.00	0.55	0.00	0.08	0.00	0.22
Lane Grp Cap (c), veh/h	0	290	0	468	0	461	0	654
V/C Ratio (X)	0.00	2.16	0.00	0.43	0.00	1.02	0.00	0.39
Avail Cap (c_a), veh/h	0	290	0	468	0	461	0	654
Upstream Filter (I)	0.00	1.00	0.00	1.00	0.00	1.00	0.00	1.00
Uniform Delay (d1), s/veh	0.0	18.6	0.0	9.8	0.0	10.5	0.0	8.3
Incr Delay (d2), s/veh	0.0	534.3	0.0	2.9	0.0	47.6	0.0	1.8
Initial Q Delay (d3), s/veh	0.0	0.0	0.0	0.0	0.0	0.0	0.0	0.0
Control Delay (d), s/veh	0.0	552.9	0.0	12.7	0.0	58.0	0.0	10.1
1st-Term Q (Q1), veh/ln	0.0	0.0	0.0	0.0	0.0	0.0	0.0	0.0
2nd-Term Q (Q2), veh/ln	0.0	43.0	0.0	0.4	0.0	6.1	0.0	0.3
3rd-Term Q (Q3), veh/ln	0.0	0.0	0.0	0.0	0.0	0.0	0.0	0.0
%ile Back of Q Factor (f_B%)	0.00	1.00	0.00	1.00	0.00	1.00	0.00	1.00
%ile Back of Q (50%), veh/ln	0.0	43.0	0.0	0.4	0.0	6.1	0.0	0.3
%ile Storage Ratio (RQ%)	0.00	44.28	0.00	0.15	0.00	5.76	0.00	0.30
Initial Q (Qb), veh	0.0	0.0	0.0	0.0	0.0	0.0	0.0	0.0
Final (Residual) Q (Qe), veh	0.0	84.3	0.0	0.0	0.0	2.5	0.0	0.0
Sat Delay (ds), s/veh	0.0	0.0	0.0	0.0	0.0	0.0	0.0	0.0
Sat Q (Qs), veh	0.0	0.0	0.0	0.0	0.0	0.0	0.0	0.0
Sat Cap (cs), veh/h	0	0	0	0	0	0	0	0
Initial Q Clear Time (tc), h	0.0	0.5	0.0	0.0	0.0	0.3	0.0	0.0

Middle Lane Group Data

Assigned Mvmt	0	2	0	4	0	6	0	8
Lane Assignment				T				T
Lanes in Grp	0	0	0	1	0	0	0	1
Grp Vol (v), veh/h	0	0	0	0	0	0	0	292
Grp Sat Flow (s), veh/h/ln	0	0	0	1617	0	0	0	1617
Q Serve Time (g_s), s	0.0	0.0	0.0	0.0	0.0	0.0	0.0	5.3
Cycle Q Clear Time (g_c), s	0.0	0.0	0.0	0.0	0.0	0.0	0.0	5.3
Lane Grp Cap (c), veh/h	0	0	0	647	0	0	0	647
V/C Ratio (X)	0.00	0.00	0.00	0.00	0.00	0.00	0.00	0.45
Avail Cap (c_a), veh/h	0	0	0	647	0	0	0	647
Upstream Filter (I)	0.00	0.00	0.00	0.00	0.00	0.00	0.00	1.00
Uniform Delay (d1), s/veh	0.0	0.0	0.0	0.0	0.0	0.0	0.0	8.8
Incr Delay (d2), s/veh	0.0	0.0	0.0	0.0	0.0	0.0	0.0	2.3
Initial Q Delay (d3), s/veh	0.0	0.0	0.0	0.0	0.0	0.0	0.0	0.0
Control Delay (d), s/veh	0.0	0.0	0.0	0.0	0.0	0.0	0.0	11.1
1st-Term Q (Q1), veh/ln	0.0	0.0	0.0	0.0	0.0	0.0	0.0	0.0
2nd-Term Q (Q2), veh/ln	0.0	0.0	0.0	0.0	0.0	0.0	0.0	0.4



3rd-Term Q (Q3), veh/ln	0.0	0.0	0.0	0.0	0.0	0.0	0.0	0.0
%ile Back of Q Factor (f_B%)	0.00	1.00	0.00	1.00	0.00	1.00	0.00	1.00
%ile Back of Q (50%), veh/ln	0.0	0.0	0.0	0.0	0.0	0.0	0.0	0.4
%ile Storage Ratio (RQ%)	0.00	0.00	0.00	0.00	0.00	0.00	0.00	0.38
Initial Q (Qb), veh	0.0	0.0	0.0	0.0	0.0	0.0	0.0	0.0
Final (Residual) Q (Qe), veh	0.0	0.0	0.0	0.0	0.0	0.0	0.0	0.0
Sat Delay (ds), s/veh	0.0	0.0	0.0	0.0	0.0	0.0	0.0	0.0
Sat Q (Qs), veh	0.0	0.0	0.0	0.0	0.0	0.0	0.0	0.0
Sat Cap (cs), veh/h	0	0	0	0	0	0	0	0
Initial Q Clear Time (tc), h	0.0	0.0	0.0	0.0	0.0	0.0	0.0	0.0

Right Lane Group Data

Assigned Mvmt	0	12	0	14	0	16	0	18
Lane Assignment		T+R		R		T+R		R
Lanes in Grp	0	1	0	2	0	1	0	1
Grp Vol (v), veh/h	0	956	0	1240	0	446	0	320
Grp Sat Flow (s), veh/h/ln	0	1649	0	1395	0	1637	0	1585
Q Serve Time (g_s), s	0.0	16.0	0.0	16.0	0.0	9.0	0.0	6.1
Cycle Q Clear Time (g_c), s	0.0	16.0	0.0	16.0	0.0	9.0	0.0	6.1
Prot RT Sat Flow (s_R), veh/h/ln	0.0	0.0	0.0	0.0	0.0	0.0	0.0	0.0
Prot RT Eff Green (g_R), s	0.0	0.0	0.0	0.0	0.0	0.0	0.0	0.0
Prop RT Outside Lane (P_R)	0.00	0.18	0.00	1.00	0.00	0.22	0.00	1.00

Lane Grp Cap (c), veh/h	0	659	0	1116	0	655	0	634
V/C Ratio (X)	0.00	1.45	0.00	1.11	0.00	0.68	0.00	0.50
Avail Cap (c_a), veh/h	0	659	0	1116	0	655	0	634
Upstream Filter (I)	0.00	1.00	0.00	1.00	0.00	1.00	0.00	1.00
Uniform Delay (d1), s/veh	0.0	12.0	0.0	12.0	0.0	9.9	0.0	9.0
Incr Delay (d2), s/veh	0.0	210.8	0.0	62.9	0.0	5.6	0.0	2.9
Initial Q Delay (d3), s/veh	0.0	0.0	0.0	0.0	0.0	0.0	0.0	0.0
Control Delay (d), s/veh	0.0	222.8	0.0	74.9	0.0	15.5	0.0	11.9
1st-Term Q (Q1), veh/ln	0.0	0.0	0.0	0.0	0.0	0.0	0.0	0.0
2nd-Term Q (Q2), veh/ln	0.0	38.6	0.0	9.7	0.0	1.0	0.0	0.5
3rd-Term Q (Q3), veh/ln	0.0	0.0	0.0	0.0	0.0	0.0	0.0	0.0
%ile Back of Q Factor (f_B%)	0.00	1.00	0.00	1.00	0.00	1.00	0.00	1.00
%ile Back of Q (50%), veh/ln	0.0	38.6	0.0	9.7	0.0	1.0	0.0	0.5
%ile Storage Ratio (RQ%)	0.00	39.73	0.00	3.77	0.00	0.97	0.00	2.41
Initial Q (Qb), veh	0.0	0.0	0.0	0.0	0.0	0.0	0.0	0.0
Final (Residual) Q (Qe), veh	0.0	74.1	0.0	31.0	0.0	0.0	0.0	0.0
Sat Delay (ds), s/veh	0.0	0.0	0.0	0.0	0.0	0.0	0.0	0.0
Sat Q (Qs), veh	0.0	0.0	0.0	0.0	0.0	0.0	0.0	0.0
Sat Cap (cs), veh/h	0	0	0	0	0	0	0	0
Initial Q Clear Time (tc), h	0.0	0.4	0.0	0.3	0.0	0.0	0.0	0.0

Intersection Summary

HCM 6th Ctrl Delay	145.3
HCM 6th LOS	F



Approach	EB	WB	NB	SB
Crosswalk Length (m)	9.73	8.56	5.26	5.32
Crosswalk Width (m)	1.20	1.20	1.20	1.20
Total Number of Lanes Crossed	8	5	4	4
Number of Right-Turn Islands	0	0	0	0
Type of Control	None	None	None	None
Corresponding Signal Phase	6	2	4	8
Effective Walk Time (s)	0.0	0.0	0.0	0.0
Right Corner Size A (m)	2.74	2.74	2.74	2.74
Right Corner Size B (m)	2.74	2.74	2.74	2.74
Right Corner Curb Radius (m)	0.00	0.00	0.00	0.00
Right Corner Total Area (sq.m)	7.51	7.51	7.51	7.51
Ped. Left-Right Flow Rate (p/h)	0	0	0	0
Ped. Right-Left Flow Rate (p/h)	0	0	0	0
Ped. R. Sidewalk Flow Rate (p/h)	0	0	0	0
Veh. Perm. L. Flow in Walk (v/h)	0	0	0	0
Veh. Perm. R. Flow in Walk (v/h)	0	0	0	0
Veh. RTOR Flow in Walk (v/h)	0	0	0	0
85th percentile speed (km/h)	50	50	50	50
Right Corner Area per Ped (sq.m)	0.0	0.0	0.0	0.0
Right Corner Quality of Service	-	-	-	-
Ped. Circulation Area (sq.m)	0.0	0.0	0.0	0.0
Crosswalk Circulation Code	-	-	-	-
Pedestrian Delay (s/p)	20.0	20.0	20.0	20.0
Pedestrian Compliance Code	Fair	Fair	Fair	Fair
Pedestrian Crosswalk Score	3.03	2.51	3.03	2.66
Pedestrian Crosswalk LOS	C	C	C	C



Approach	EB	WB	NB	SB
Bicycle Flow Rate (bike/h)	0	0	0	0
Total Flow Rate (veh/h)	1443	869	1583	917
Effct. Green for Bike (s)	16.0	16.0	16.0	16.0
Cross Street Width (m)	17.26	17.46	28.08	31.93
Through Lanes Number	2	2	2	2
Through Lane Width (m)	3.60	3.60	3.60	3.60
Bicycle Lane Width (m)	0.00	0.00	0.00	0.00
Striped Parking Lane Width (m)	0.00	0.00	0.00	0.00
Paved Shoulder Width (m)	0.00	0.00	0.00	0.00
Curb Is Present?	No	No	No	No
On Street Parking?	No	No	No	No
Bicycle Lane Capacity (bike/h)	800	800	800	800
Bicycle Delay (s/bike)	7.2	7.2	7.2	7.2
Bicycle Compliance	Good	Good	Good	Good
Bicycle LOS Score	3.66	3.19	4.32	3.96
Bicycle LOS	D	C	D	D



Link: AV. SAN MARTIN, Av. Ejercito to Ca. Confraternidad

Variable	Value	Comments
Travel Time (s)	7	Travel Time okay For Coordination
CF1	96	
Traffic / Storage Space	4.42	Traffic exceeds 80% of storage, coordination needed
CF2	100	
Proportion of Traffic In Platoon	0.72	Traffic moderately platooned
Ap, platoon adjustment	-5	
Main Street Volume (vph)	5089	High Volumes, coordination is high priority
Av, volume adjustment	20	
Cycle Length	90	at Av. Ejercito
Cycle Length	90	at Ca. Confraternidad
Combined Cycle Length	90	
Cycle Length Increase	0	
Ac, Cycle Adjustment	0	
CF, Coordinatability Factor	115	Coordination definitely recommended

Link: AV. SAN MARTIN, Ca. Confraternidad to

Variable	Value	Comments
Travel Time (s)	41	Travel Time okay For Coordination
CF1	51	
Traffic / Storage Space	0.19	Storage Space is adequate
CF2	19	
Proportion of Traffic In Platoon	0.74	Traffic moderately platooned
Ap, platoon adjustment	-4	
Main Street Volume (vph)	3227	High Volumes, coordination is high priority
Av, volume adjustment	20	
Cycle Length	90	at Ca. Confraternidad
Cycle Length	90	at
Combined Cycle Length	90	
Cycle Length Increase	0	
Ac, Cycle Adjustment	0	
CF, Coordinatability Factor	67	Coordination probably recommended



Link: , AV. SAN MARTIN to Av.Infancia

Variable	Value	Comments
Travel Time (s)	5	Travel Time okay For Coordination
CF1	98	
Traffic / Storage Space	3.56	Traffic exceeds 80% of storage, coordination needed
CF2	100	
Proportion of Traffic In Platoon	0.71	Traffic moderately platooned
Ap, platoon adjustment	-6	
Main Street Volume (vph)	1833	High Volumes, coordination is high priority
Av, volume adjustment	16	
Cycle Length	90	at AV. SAN MARTIN
Cycle Length	90	at Av.Infancia
Combined Cycle Length	90	
Cycle Length Increase	0	
Ac, Cycle Adjustment	0	
CF, Coordinatability Factor	110	Coordination definitely recommended

Link: , AV. SAN MARTIN to Av.Infancia

Variable	Value	Comments
Travel Time (s)	5	Travel Time okay For Coordination
CF1	98	
Traffic / Storage Space	3.56	Traffic exceeds 80% of storage, coordination needed
CF2	100	
Proportion of Traffic In Platoon	0.71	Traffic moderately platooned
Ap, platoon adjustment	-6	
Main Street Volume (vph)	1833	High Volumes, coordination is high priority
Av, volume adjustment	16	
Cycle Length	90	at AV. SAN MARTIN
Cycle Length	90	at Av.Infancia
Combined Cycle Length	90	
Cycle Length Increase	0	
Ac, Cycle Adjustment	0	
CF, Coordinatability Factor	110	Coordination definitely recommended



Link: , AV. SAN MARTIN to Av.Infancia

Variable	Value	Comments
Travel Time (s)	5	Travel Time okay For Coordination
CF1	98	
Traffic / Storage Space	3.56	Traffic exceeds 80% of storage, coordination needed
CF2	100	
Proportion of Traffic In Platoon	0.71	Traffic moderately platooned
Ap, platoon adjustment	-6	
Main Street Volume (vph)	1833	High Volumes, coordination is high priority
Av, volume adjustment	16	
Cycle Length	90	at AV. SAN MARTIN
Cycle Length	90	at Av.Infancia
Combined Cycle Length	90	
Cycle Length Increase	0	
Ac, Cycle Adjustment	0	
CF, Coordinatability Factor	110	Coordination definitely recommended

Link: , to Av.Infancia

Variable	Value	Comments
Travel Time (s)	17	Travel Time okay For Coordination
CF1	82	
Traffic / Storage Space	0.52	Storage Space is adequate
CF2	52	
Proportion of Traffic In Platoon	0.65	Traffic moderately platooned
Ap, platoon adjustment	-9	
Main Street Volume (vph)	1623	High Volumes, coordination is high priority
Av, volume adjustment	14	
Cycle Length	45	at
Cycle Length	90	at Av.Infancia
Combined Cycle Length	90	
Cycle Length Increase	0	
Ac, Cycle Adjustment	0	
CF, Coordinatability Factor	87	Coordination definitely recommended



Link: AV. 28 DE JULIO, Av. Mateo Pumacahua to Ca. La Union

Variable	Value	Comments
Travel Time (s)	38	Travel Time okay For Coordination
CF1	54	
Traffic / Storage Space	0.15	Storage Space is adequate
CF2	15	
Proportion of Traffic In Platoon	0.92	Traffic heavily platooned, coordination is appropriate
Ap, platoon adjustment	6	
Main Street Volume (vph)	2716	High Volumes, coordination is high priority
Av, volume adjustment	20	
Cycle Length	45	at Av. Mateo Pumacahua
Cycle Length	90	at Ca. La Union
Combined Cycle Length	90	
Cycle Length Increase	0	
Ac, Cycle Adjustment	0	
CF, Coordinatability Factor	80	Coordination definitely recommended

Link: AV. 28 DE JULIO, Av. Mateo Pumacahua to Ca. La Union

Variable	Value	Comments
Travel Time (s)	38	Travel Time okay For Coordination
CF1	54	
Traffic / Storage Space	0.15	Storage Space is adequate
CF2	15	
Proportion of Traffic In Platoon	0.92	Traffic heavily platooned, coordination is appropriate
Ap, platoon adjustment	6	
Main Street Volume (vph)	2716	High Volumes, coordination is high priority
Av, volume adjustment	20	
Cycle Length	45	at Av. Mateo Pumacahua
Cycle Length	90	at Ca. La Union
Combined Cycle Length	90	
Cycle Length Increase	0	
Ac, Cycle Adjustment	0	
CF, Coordinatability Factor	80	Coordination definitely recommended



Link: AV. 28 DE JULIO, Jr. Los Sauces to Av. Velasco

Variable	Value	Comments
Travel Time (s)	47	Travel Time okay For Coordination
CF1	42	
Traffic / Storage Space	0.09	Storage Space is adequate
CF2	9	
Proportion of Traffic In Platoon	0.76	Traffic moderately platooned
Ap, platoon adjustment	-3	
Main Street Volume (vph)	2613	High Volumes, coordination is high priority
Av, volume adjustment	20	
Cycle Length	90	at Jr. Los Sauces
Cycle Length	40	at Av. Velasco
Combined Cycle Length	90	
Cycle Length Increase	5	
Ac, Cycle Adjustment	-2	
CF, Coordinatability Factor	57	Coordination probably recommended

